

[54] WALL TELEPHONE

[75] Inventors: Robert M. Fitzgerald, Golden; Richard W. Toussaint, Evergreen, both of Colo.

[73] Assignee: Com-Line, Inc., Denver, Colo.

[\*\*] Term: 14 Years

[21] Appl. No.: 78,064

[22] Filed: Jul. 27, 1987

[52] U.S. Cl. .... D14/56

[58] Field of Search ..... D14/52, 53, 62, 60, D14/56, 63, 61; 379/419, 428, 431, 433, 434, 435, 436, 440

[56] References Cited

U.S. PATENT DOCUMENTS

D. 45,322	3/1914	Barnes	.....	D14/56
D. 210,379	3/1968	Perkins	.....	D14/53
D. 230,158	1/1974	Genaro et al.	.....	D14/64 UX
D. 267,021	11/1982	Einhorn et al.	.....	D14/56
376,615	1/1888	Thurber et al.	.....	379/454
501,405	7/1893	Burchell et al.	.....	379/454
549,860	11/1895	Stromberg et al.	.....	379/440
1,383,472	7/1921	Long	.....	D14/56
2,133,468	10/1938	Obergfeld	.....	D14/56

OTHER PUBLICATIONS

Ad sheet in color; TeleConcepts Corp.; Chicago E.S.: Model 549246, Country Wall.

AT&T brochure released 12/1982; product catalog type; Note Country Junction® Telephone.

Grandcom, Inc. booklet "Telephone Headquarters of America", at pp. 6 & 7, Models: No. 1, Wood Wall Phone; No. 2 Early American.

Spiegel catalogs 1985 Spring; p. 510, Item A County Line Phone; 1987 Spring & Summer catalog; at p. 466; Item A Country Wall Phone; Item B Country Store Phone.

Primary Examiner—Horace B. Fay

Attorney, Agent, or Firm—Morton S. Adler

[57] CLAIM

The ornamental design for a wall telephone, as shown.

DESCRIPTION

FIG. 1 is a left side, top and front perspective view of a wall telephone showing our new design;

FIGS. 2 and 3 are respectively front and rear elevational views thereof;

FIGS. 4 and 5 are respectively right and left side elevational views thereof; and

FIGS. 6 and 7 are respectively top and bottom plan views thereof.

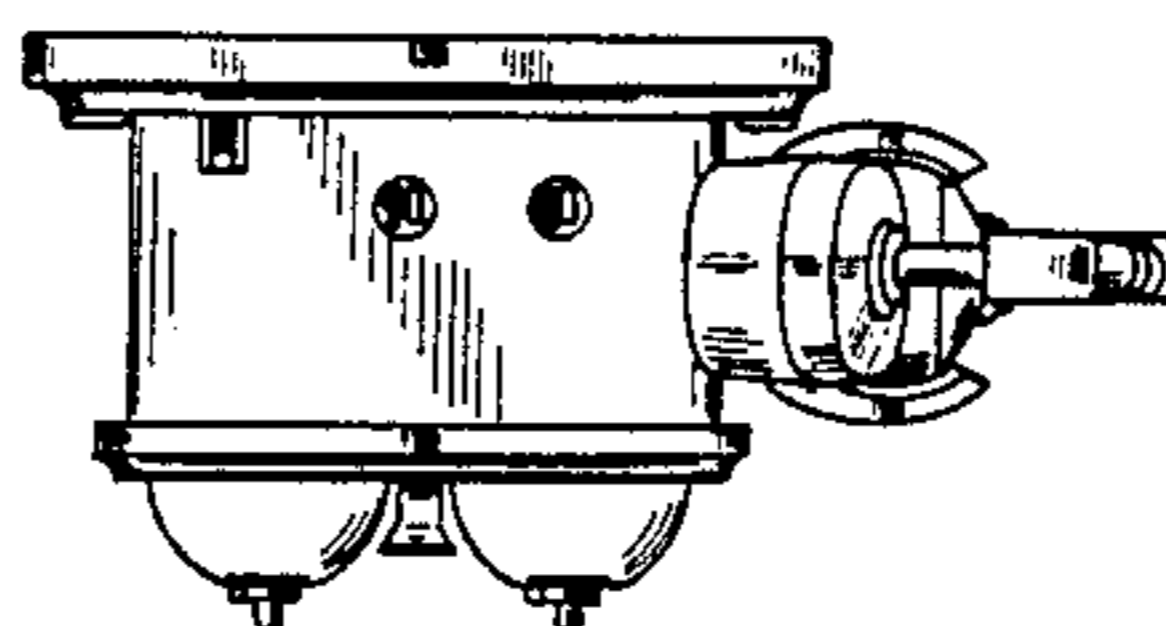
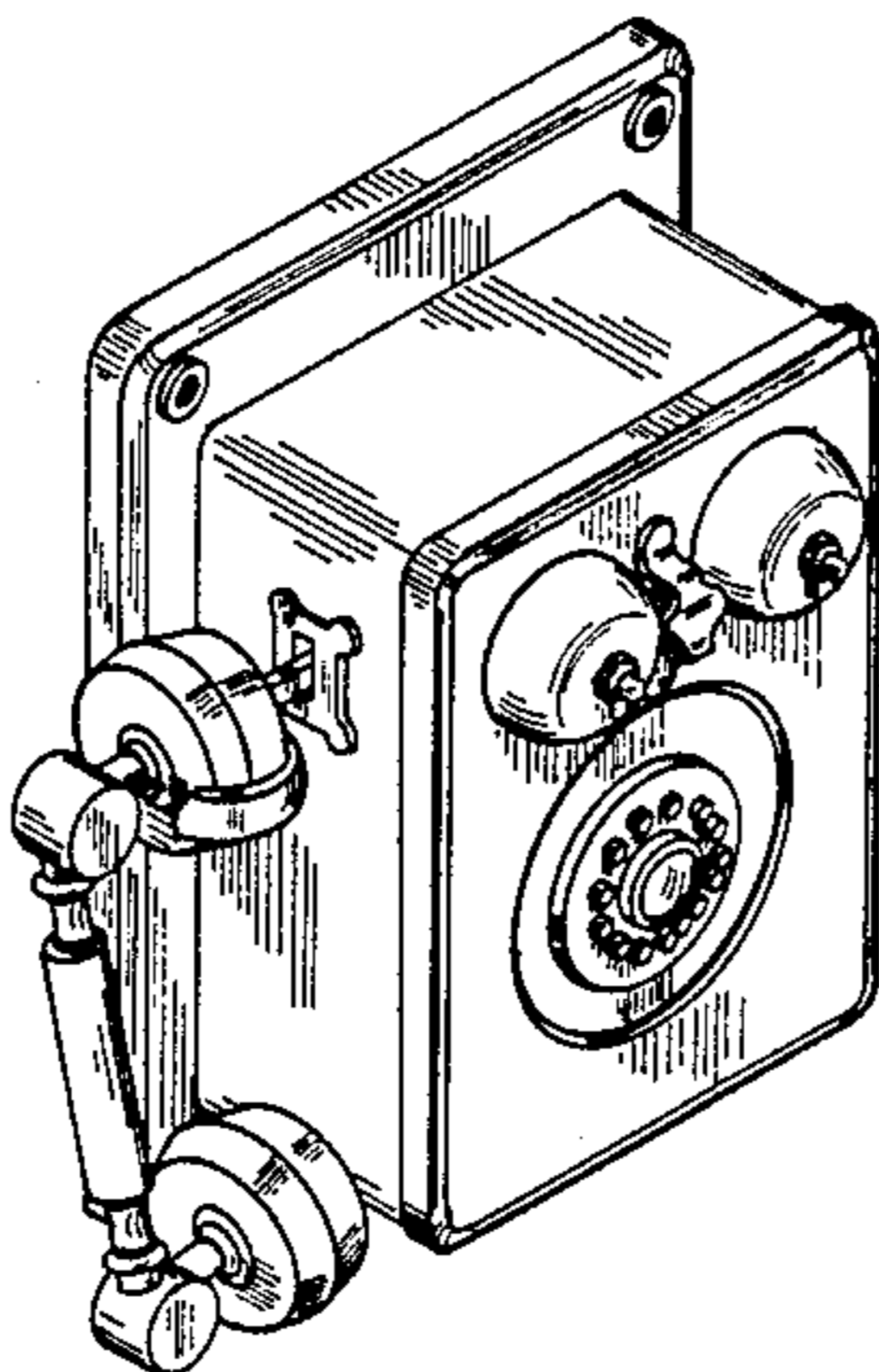

FIG. 1

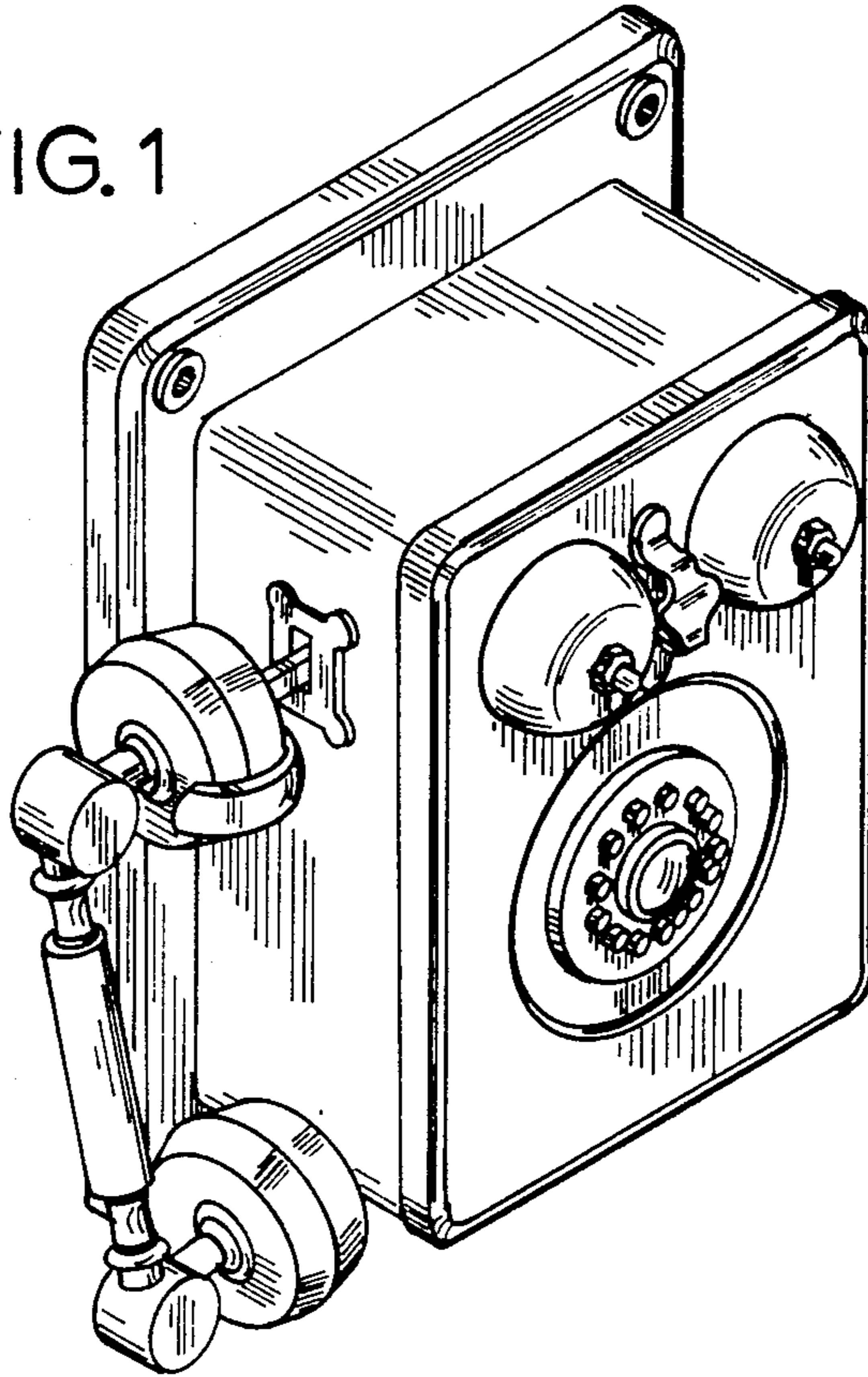

FIG. 6

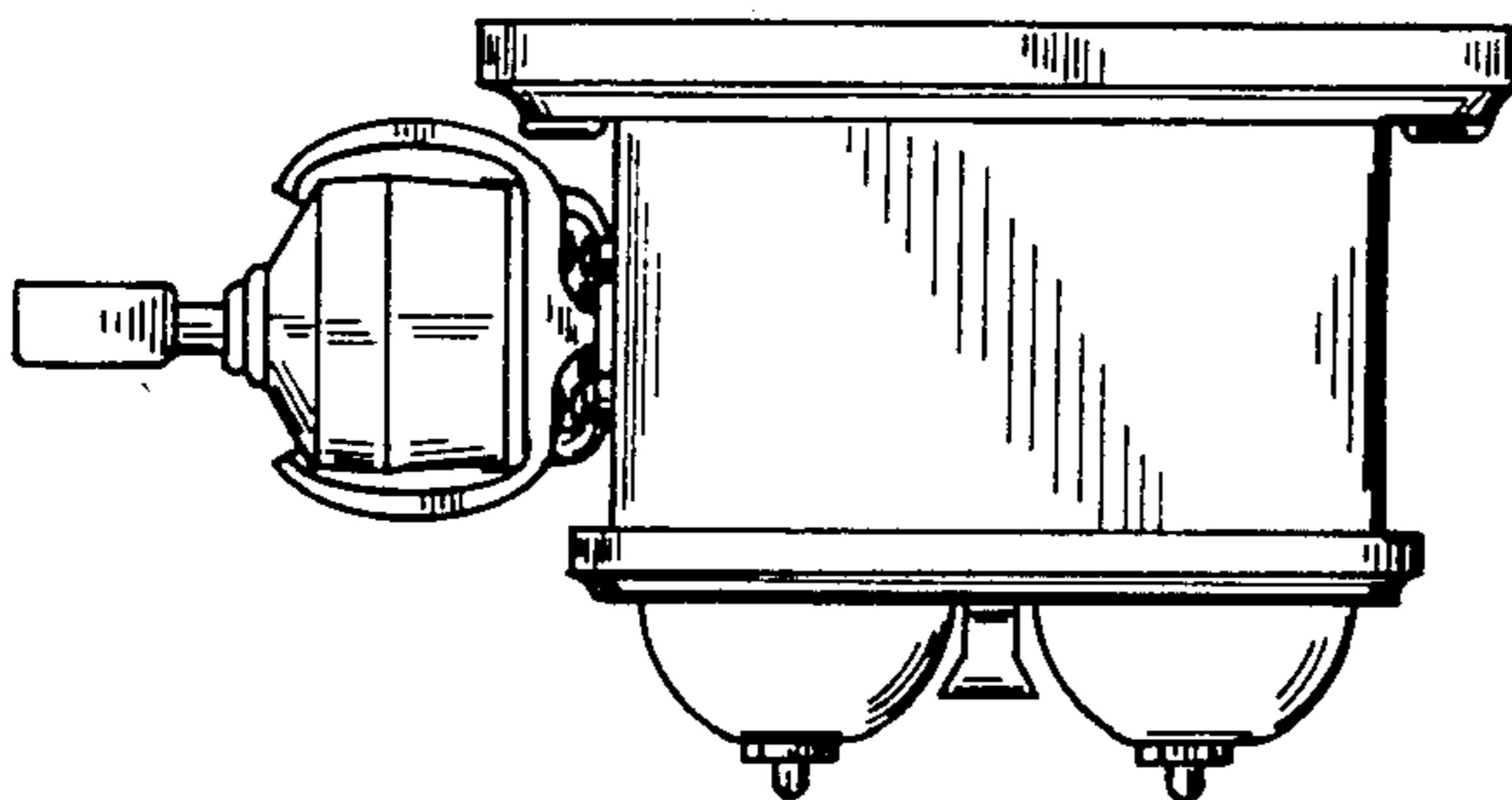

FIG. 7

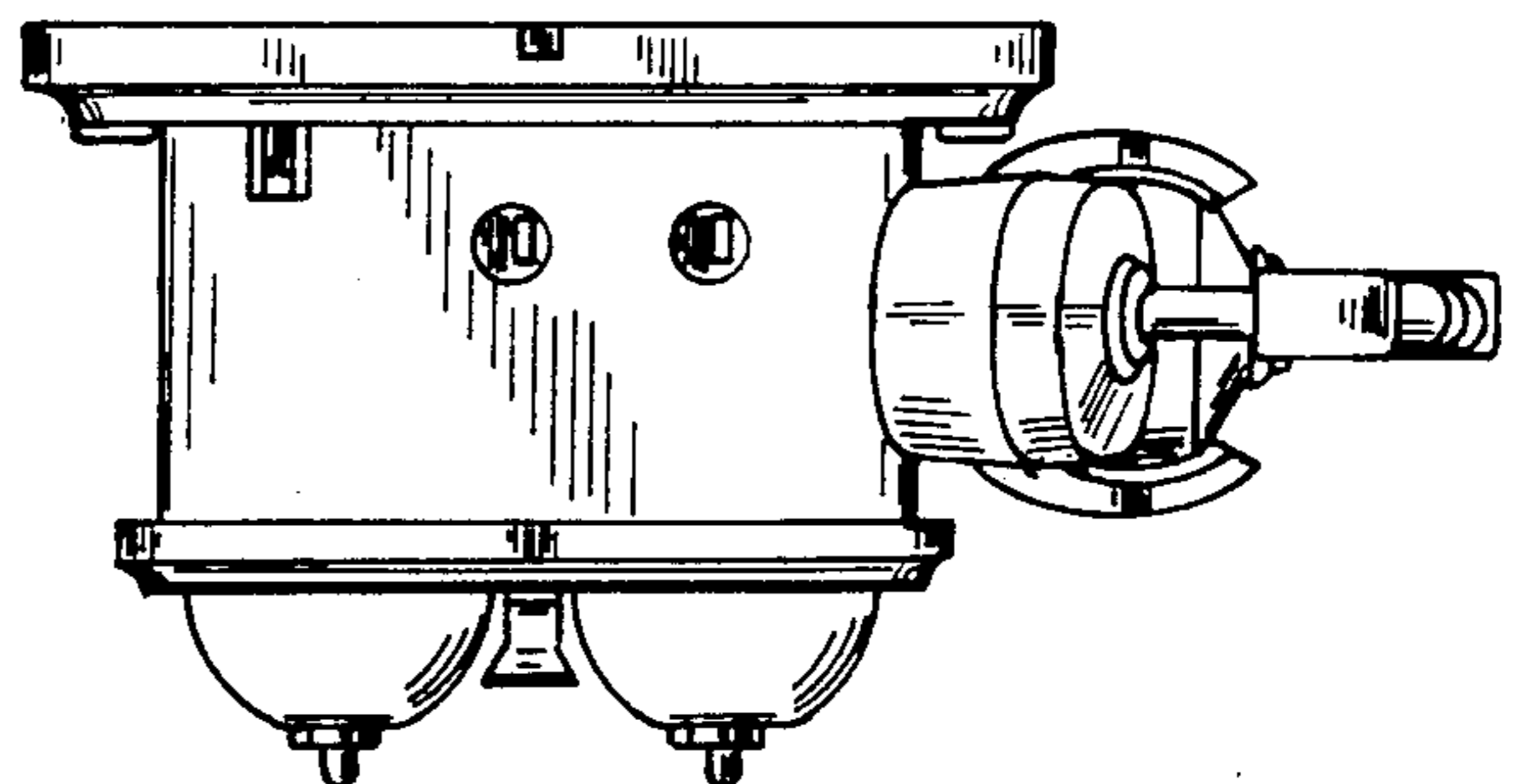

FIG. 2

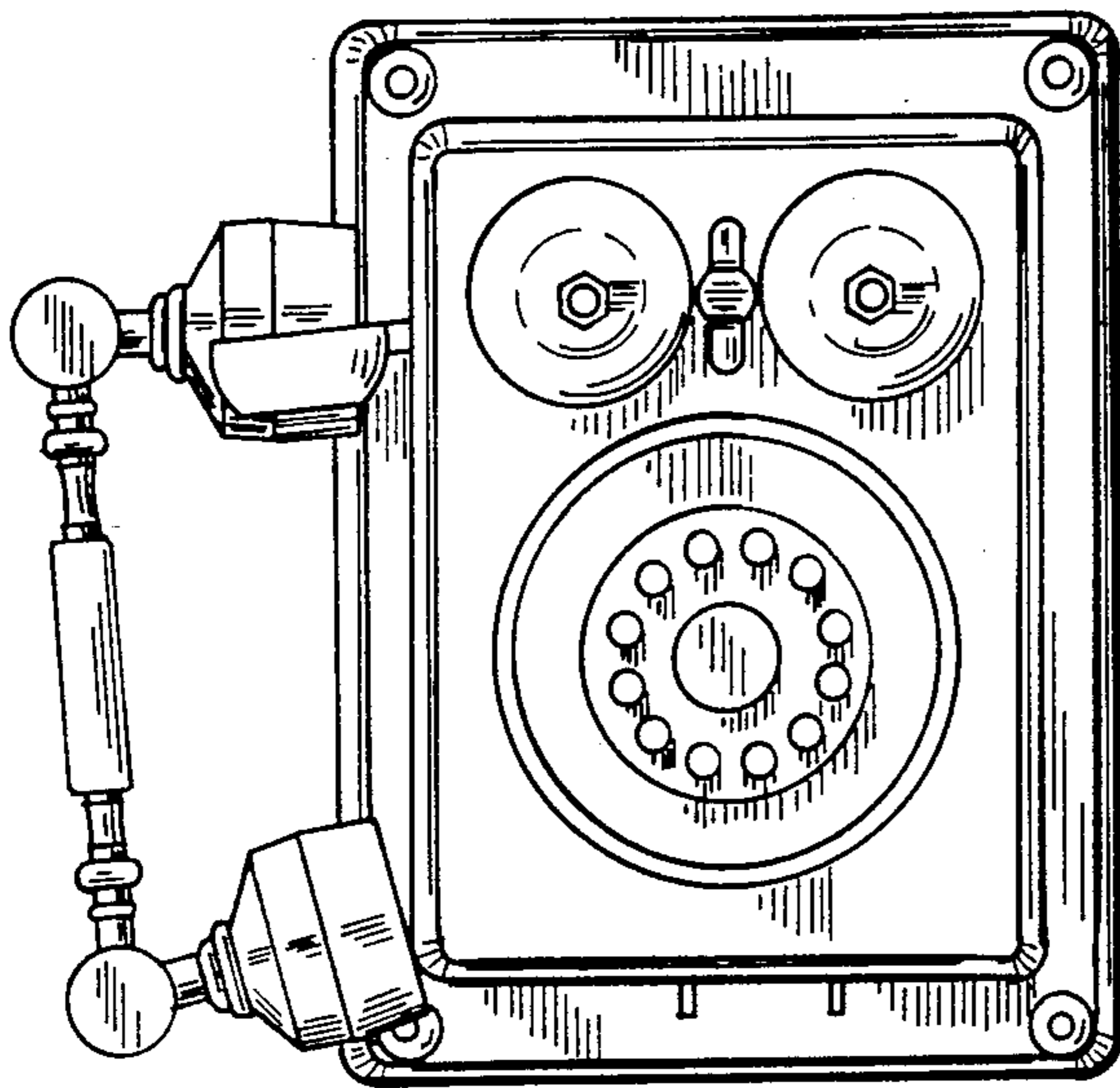

FIG. 3

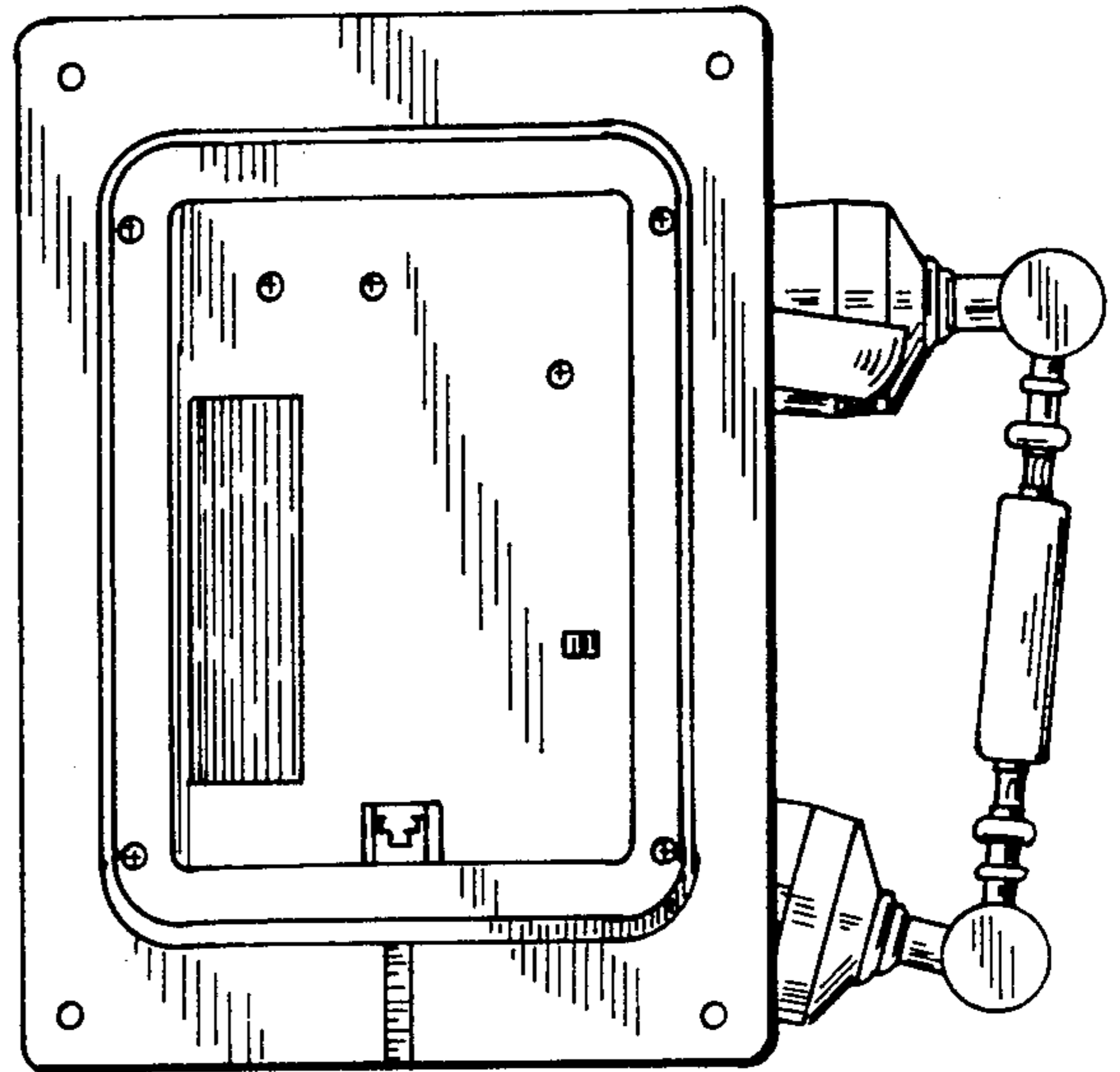

FIG. 4

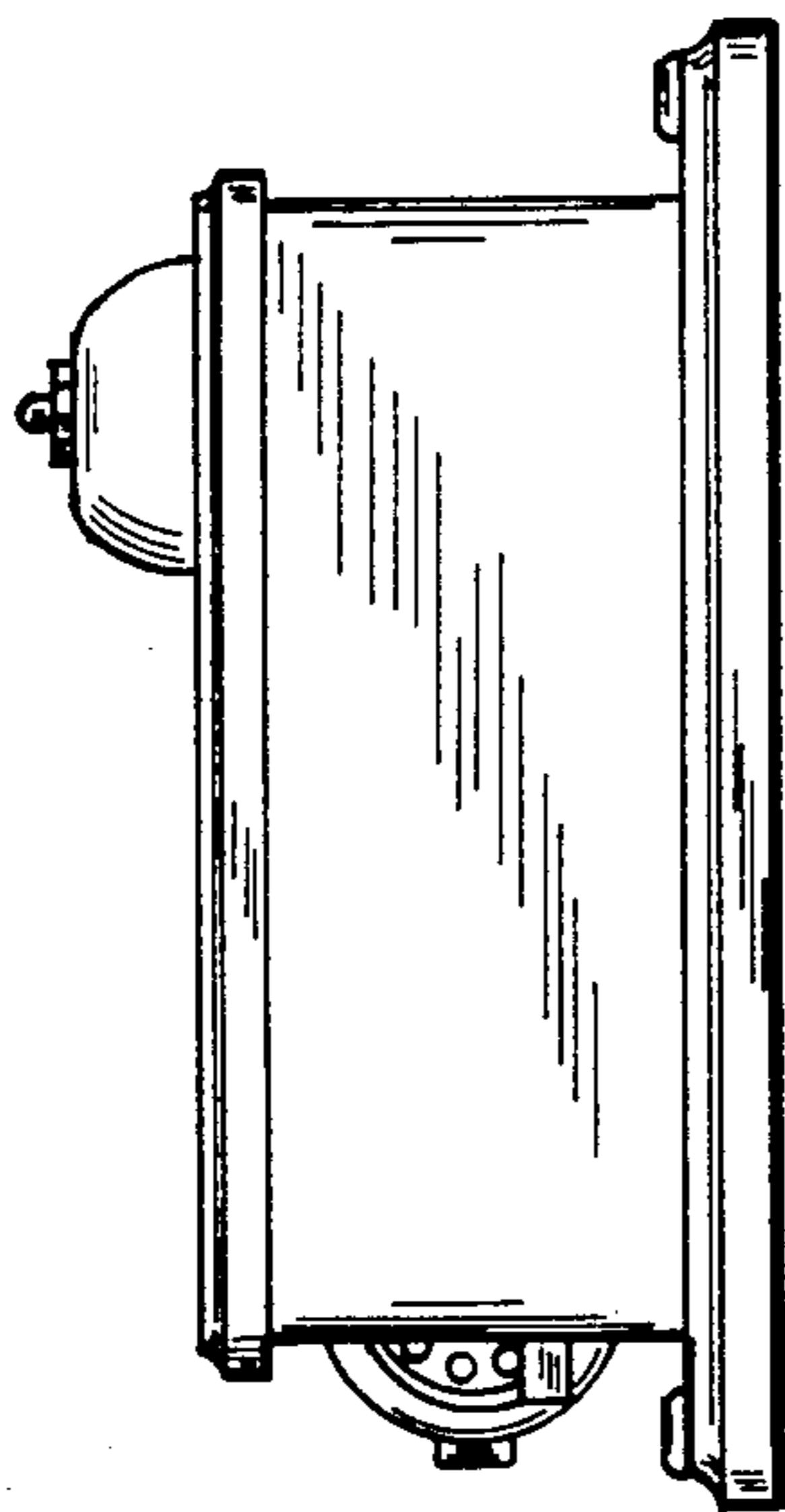

FIG. 5

