

[54] FILTER SUPPORT PLATE

[75] Inventor: Knud V. Larsen, Maribo, Denmark

[73] Assignee: De Danske Sukkerfabrikker, Copenhagen, Denmark

[**] Term: 14 Years

[21] Appl. No.: 886,435

[22] Filed: Jul. 17, 1986

[52] U.S. Cl. D23/209

[58] Field of Search D23/4, 149; 210/282, 210/350, 416.2, 455

[56] References Cited

U.S. PATENT DOCUMENTS

3,208,595	9/1965	Butler	210/282
3,361,261	2/1968	Fairey et al.	210/455 X
4,138,337	2/1979	Smith	210/282 X
4,233,043	11/1980	Catterson	D23/149 X

4,311,592	1/1982	Brown	210/416.2
4,379,051	4/1983	Hiesinger et al.	210/350 X
4,448,695	5/1984	Gordon, Jr. et al.	210/282 X
4,493,815	1/1985	Fernwood et al.	210/455 X

Primary Examiner—Wallace R. Burke
Assistant Examiner—Brian N. Vinson
Attorney, Agent, or Firm—Oblon, Fisher, Spivak, McClelland & Maier

[57] CLAIM

The ornamental design for a filter support plate, as shown.

DESCRIPTION

FIG. 1 is a front elevational view of a filter support plate showing my new design;
FIG. 2 is a bottom plan view thereof;
FIG. 3 is a rear elevational view thereof;
FIG. 4 is a top plan view thereof;
FIG. 5 is a left side elevational view thereof; and
FIG. 6 is a right side elevational view thereof.

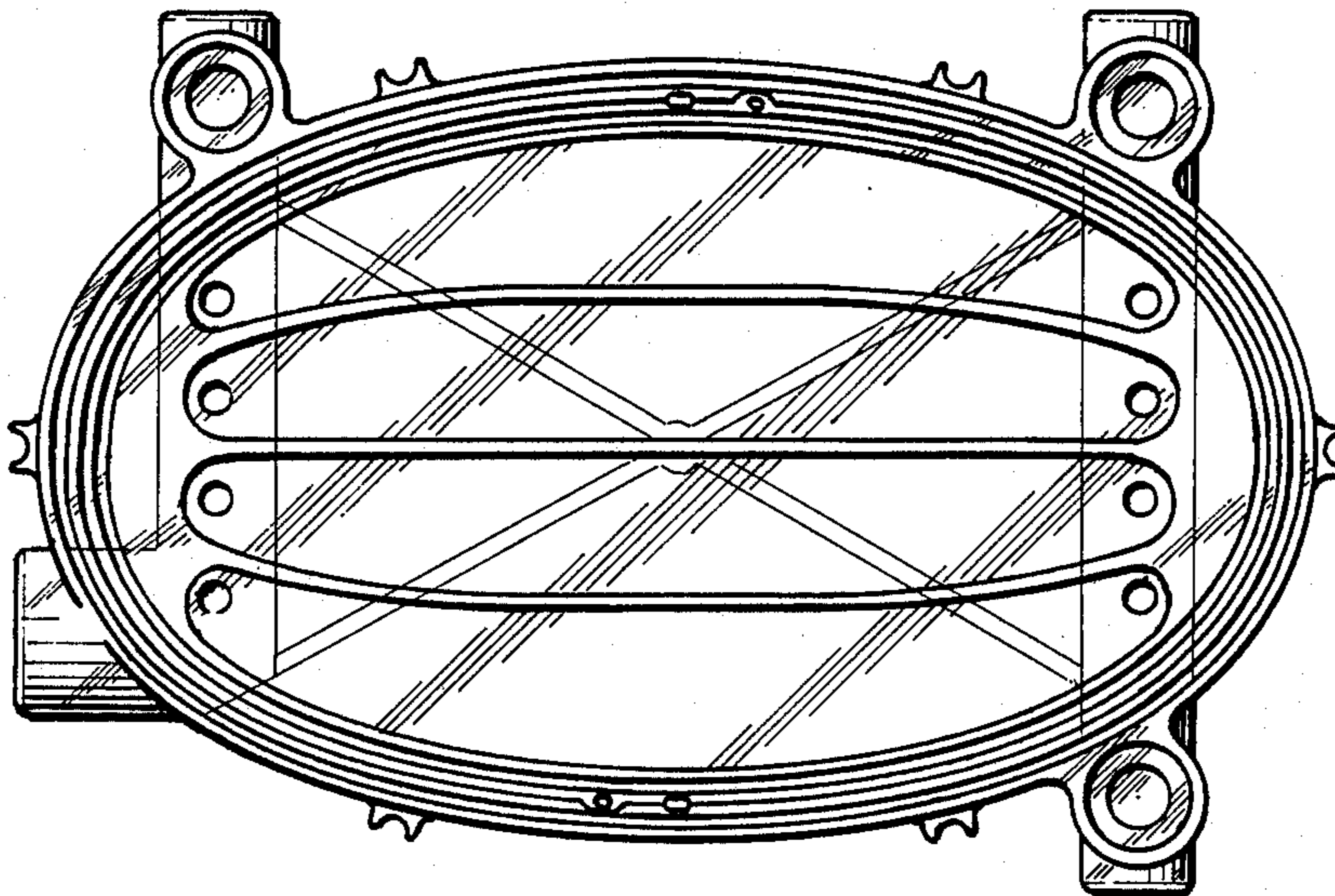

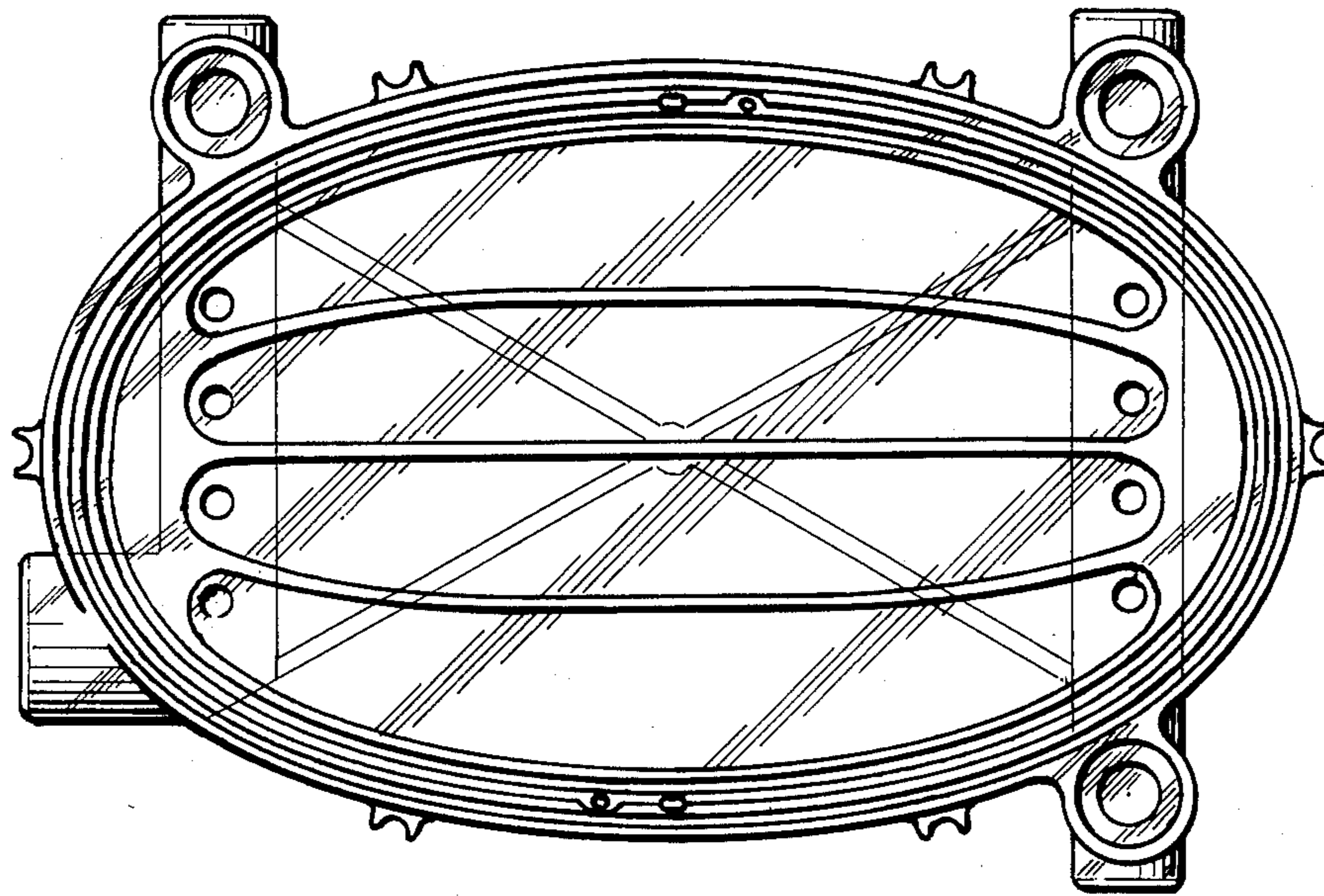

FIG. 1

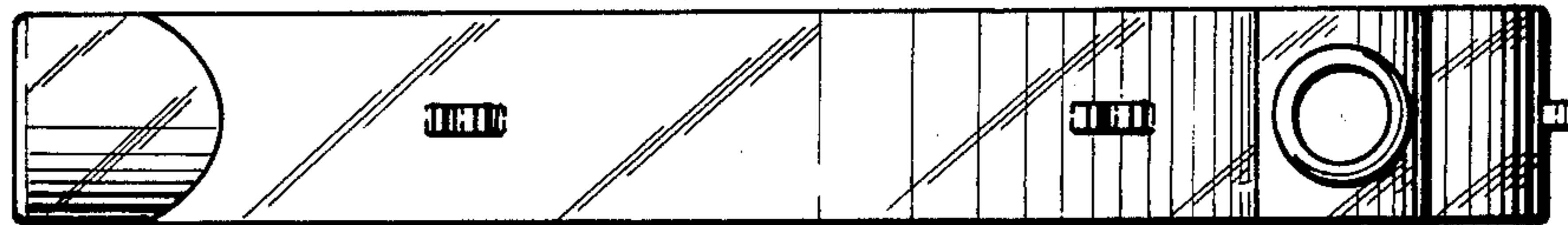

FIG. 2

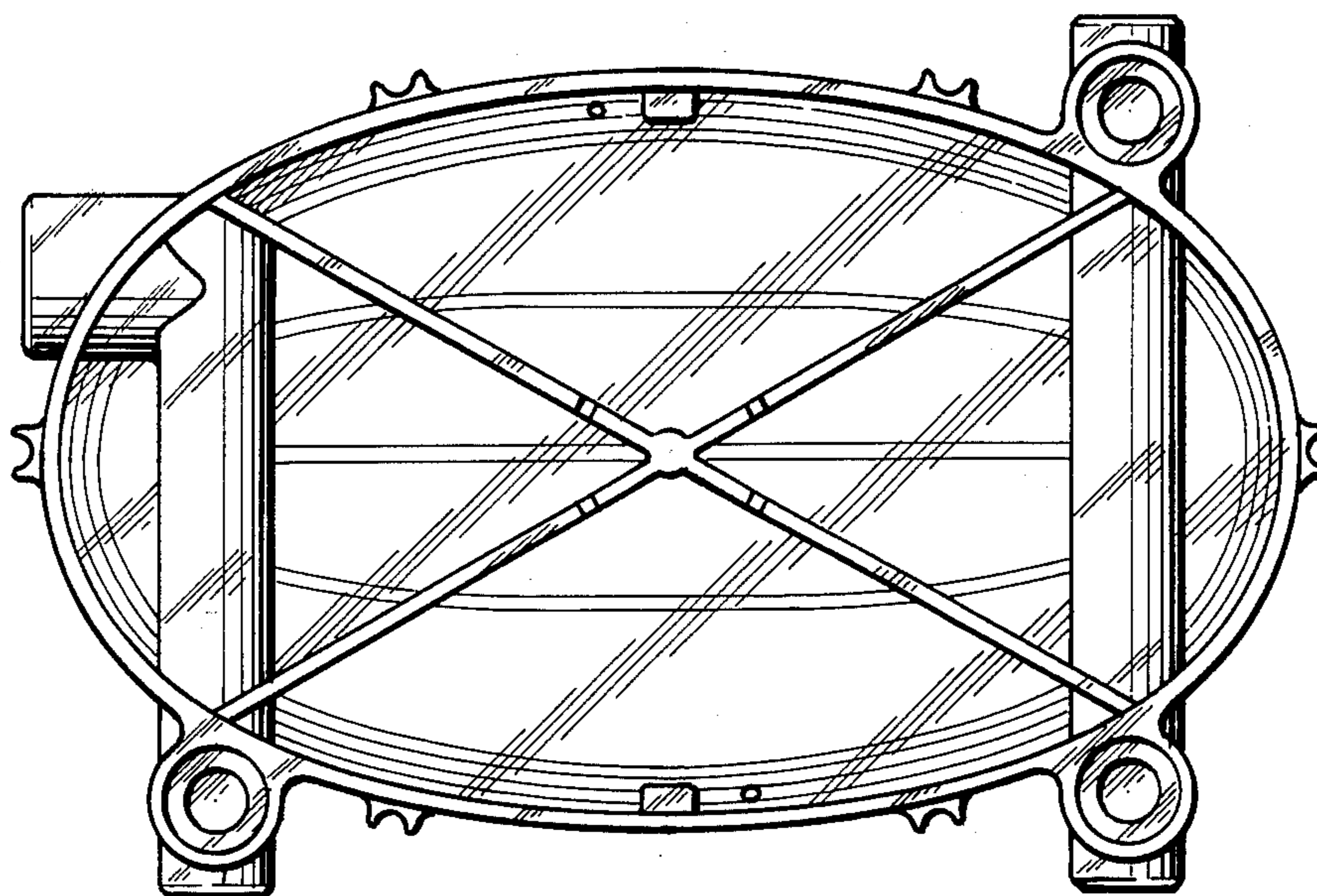

FIG. 3

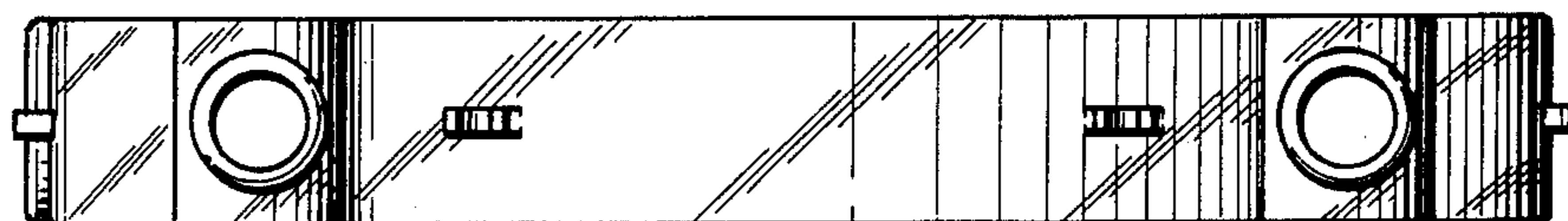

FIG. 4

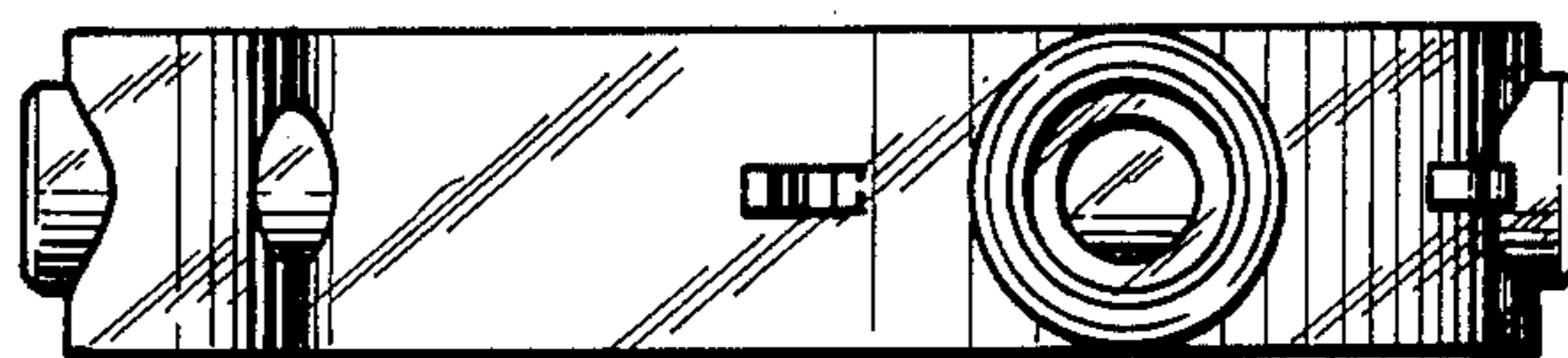

FIG. 5

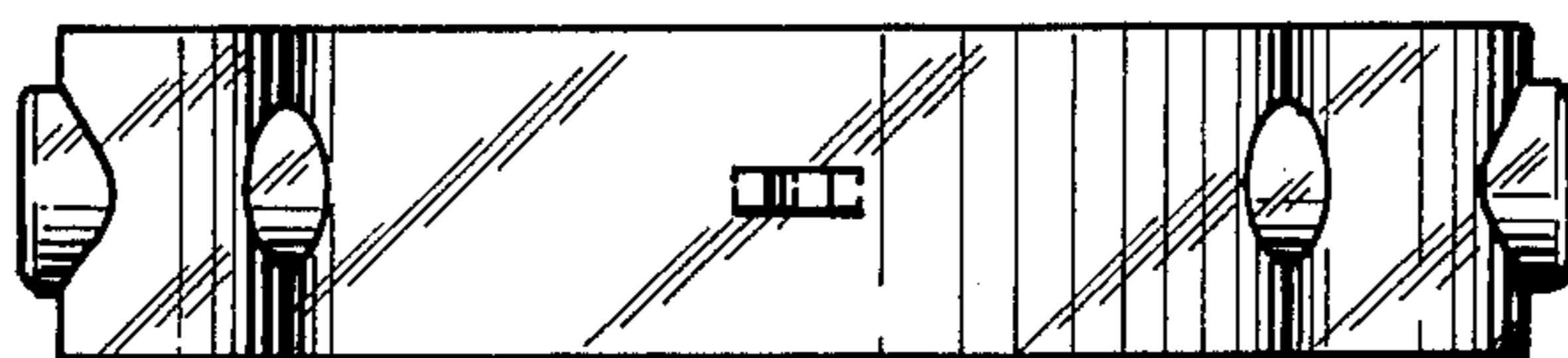

FIG. 6

UNITED STATES PATENT AND TRADEMARK OFFICE
CERTIFICATE OF CORRECTION

PATENT NO. : Des. 297,452
DATED : Aug. 30, 1988
INVENTOR(S) : Knud V. LARSEN

It is certified that error appears in the above-identified patent and that said Letters Patent is hereby corrected as shown below:

On the Title Page, Item [30]:

The Foreign Application Priority Data has been omitted; please add as follows:

-- Jan. 17, 1986 [DK] Denmark DK-MA 0037/1986 --

Signed and Sealed this
Twenty-fourth Day of January, 1989

Attest:

Attesting Officer

DONALD J. QUIGG

Commissioner of Patents and Trademarks