

[54] **GOLF PUTTER HEAD**

[76] **Inventor: William B. Shearer, 2905 W. Main St., Muncie, Ind. 47305**

[**] **Term: 14 Years**

[21] **Appl. No.: 771,833**

[22] **Filed: Sep. 3, 1985**

[52] **U.S. Cl. D21/219**

[58] **Field of Search D21/217, 219;
273/163 R, 167-175**

[56] **References Cited**

U.S. PATENT DOCUMENTS

D. 207,228 3/1967 Solheim D21/219

D. 270,852 10/1983 Mahaffey et al. D21/217

Primary Examiner—Melvin B. Feifer
Attorney, Agent, or Firm—J. David Haynes

[57] **CLAIM**

The ornamental design for a golf putter head, as shown.

DESCRIPTION

FIG. 1 is a left side view of a golf putter head showing my new design.

FIG. 2 is a top view thereof.

FIG. 3 is a right side view thereof.

FIG. 4 is a bottom view thereof.

FIG. 5 is a rear view thereof.

FIG. 6 is a front view thereof.

FIG. 7 is a perspective view thereof.

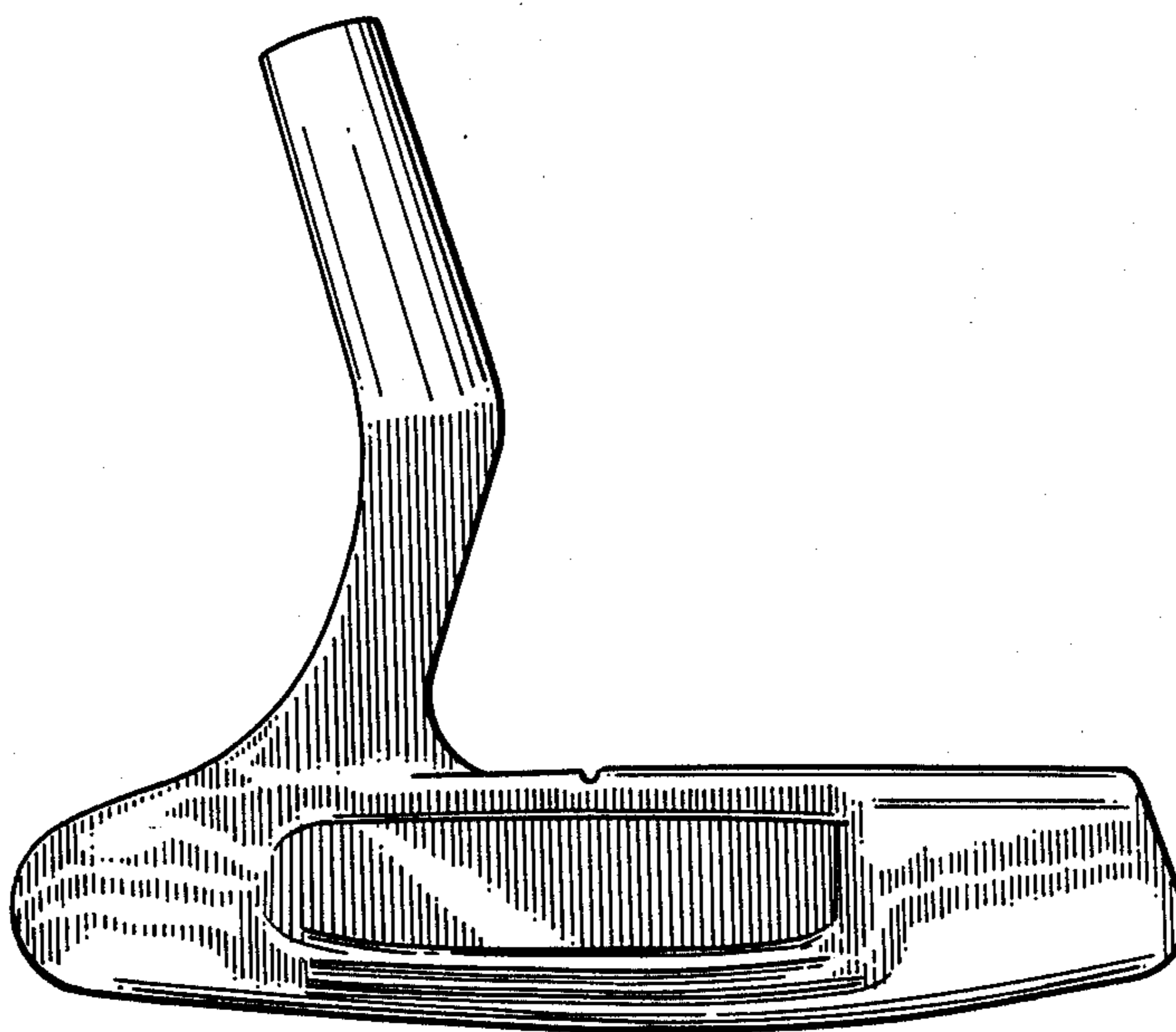

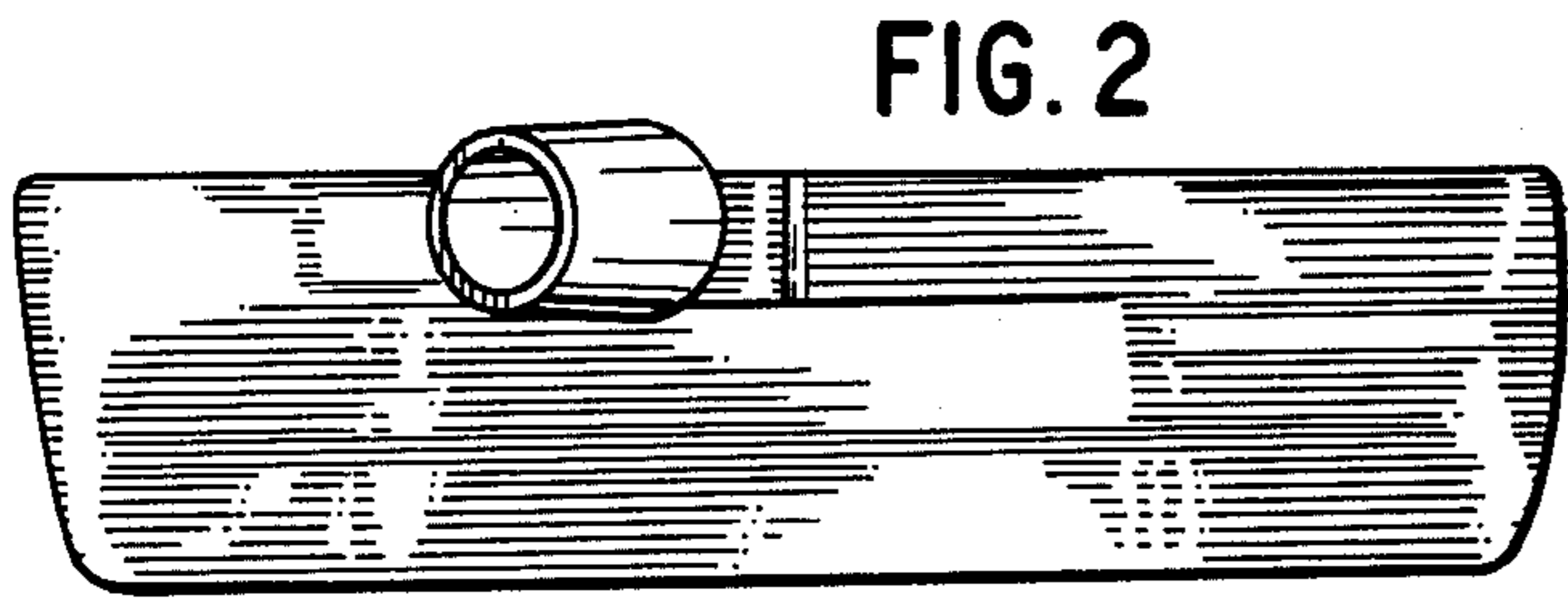

FIG. 2

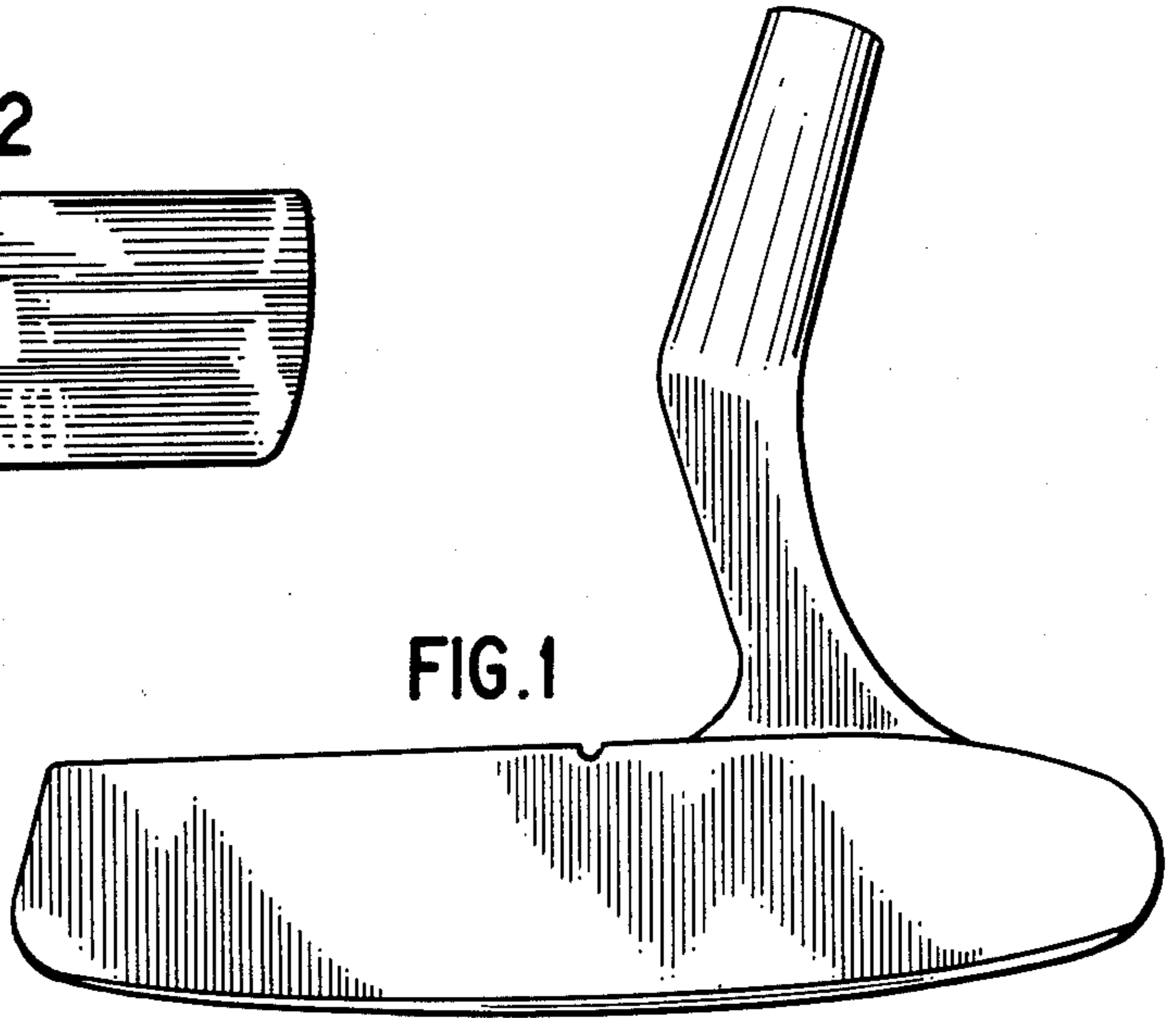

FIG. 1

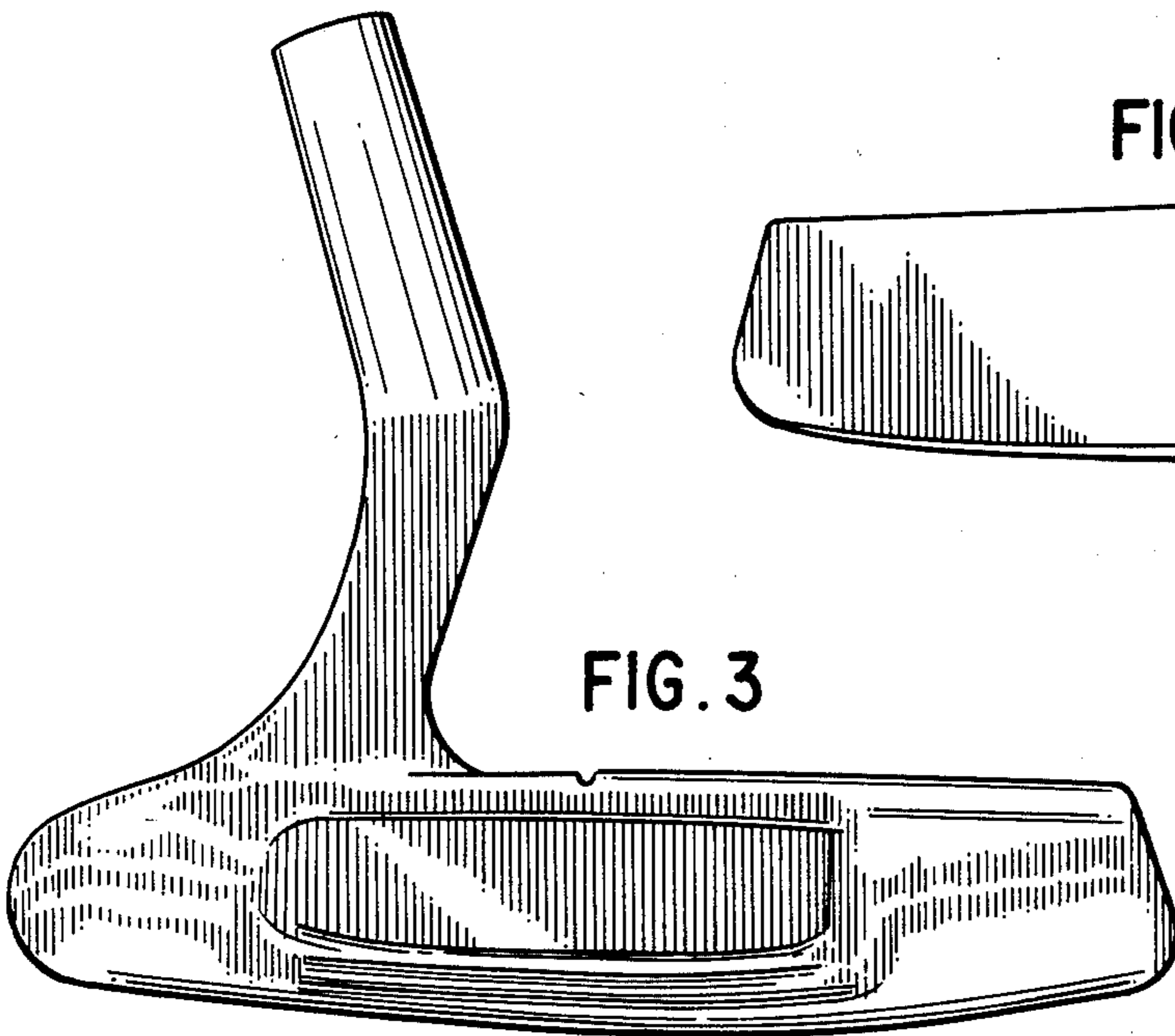

FIG. 3

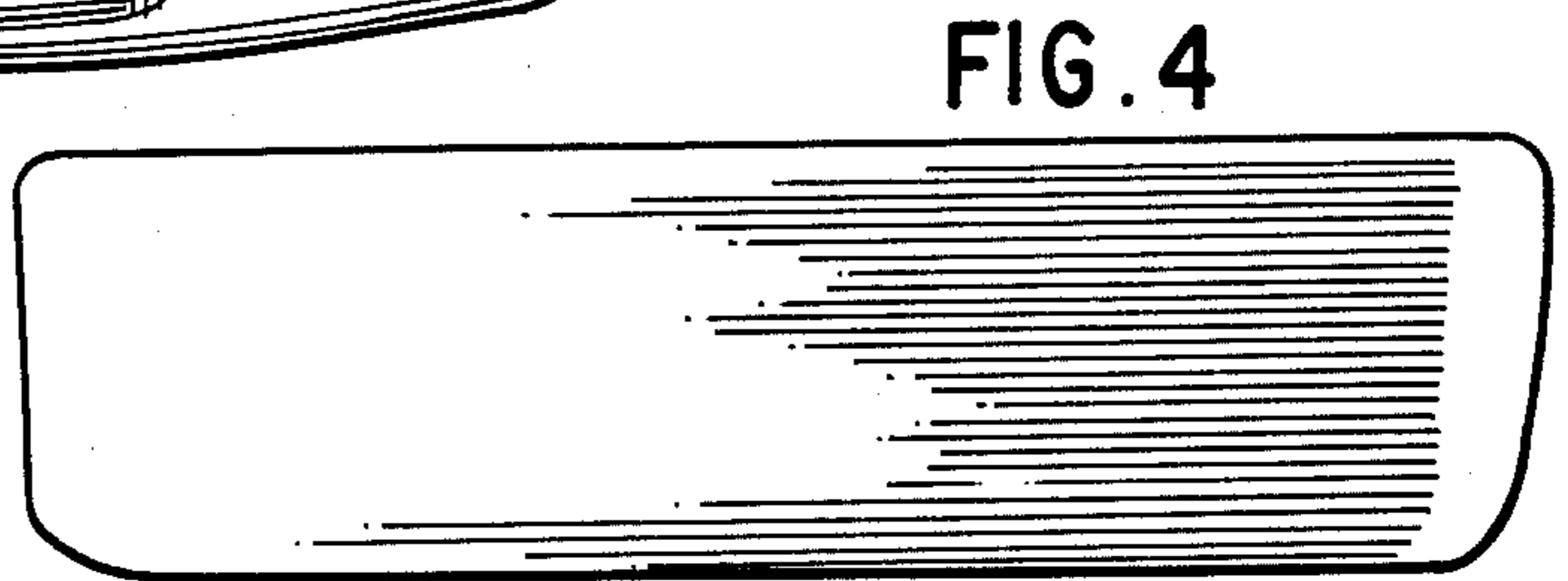

FIG. 4

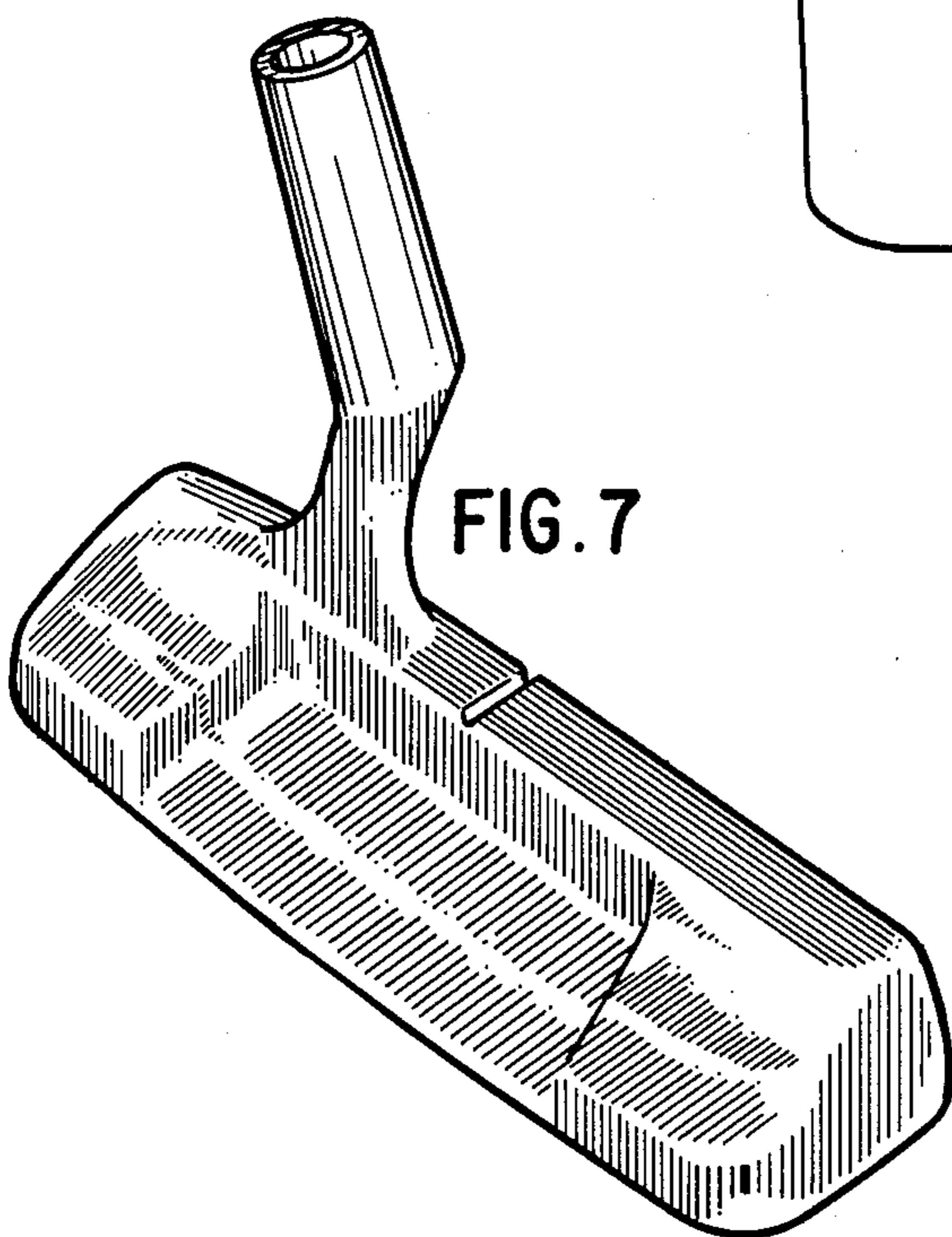

FIG. 7

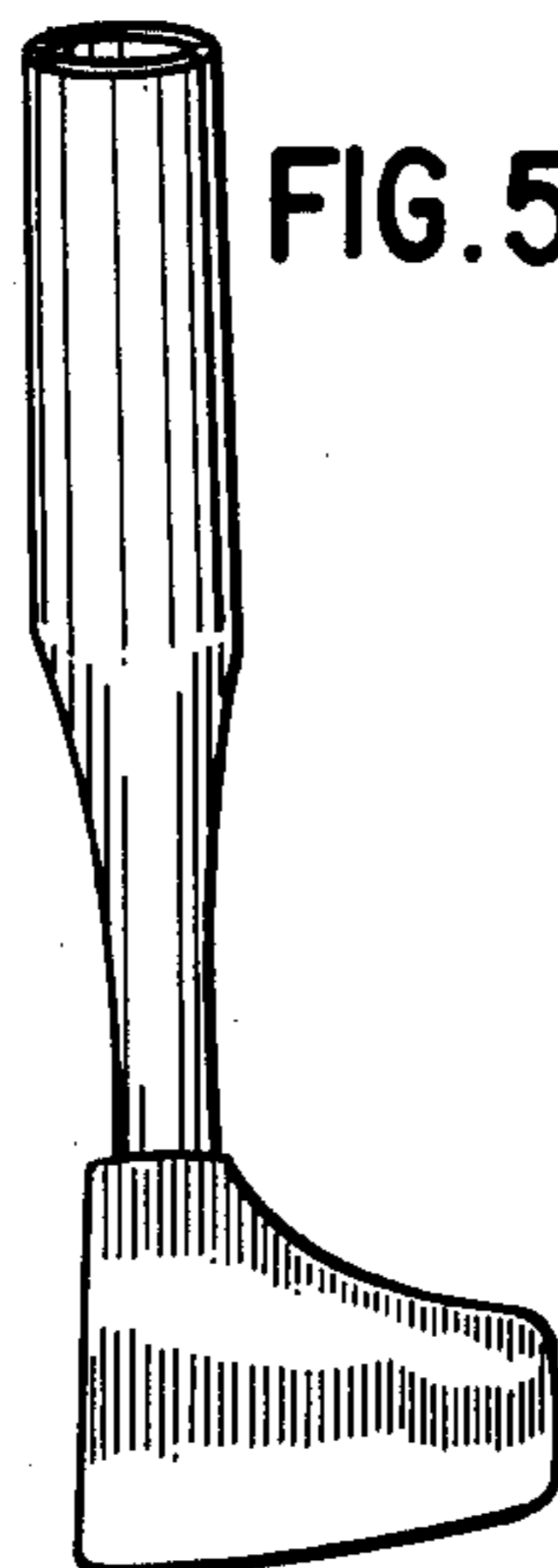

FIG. 5

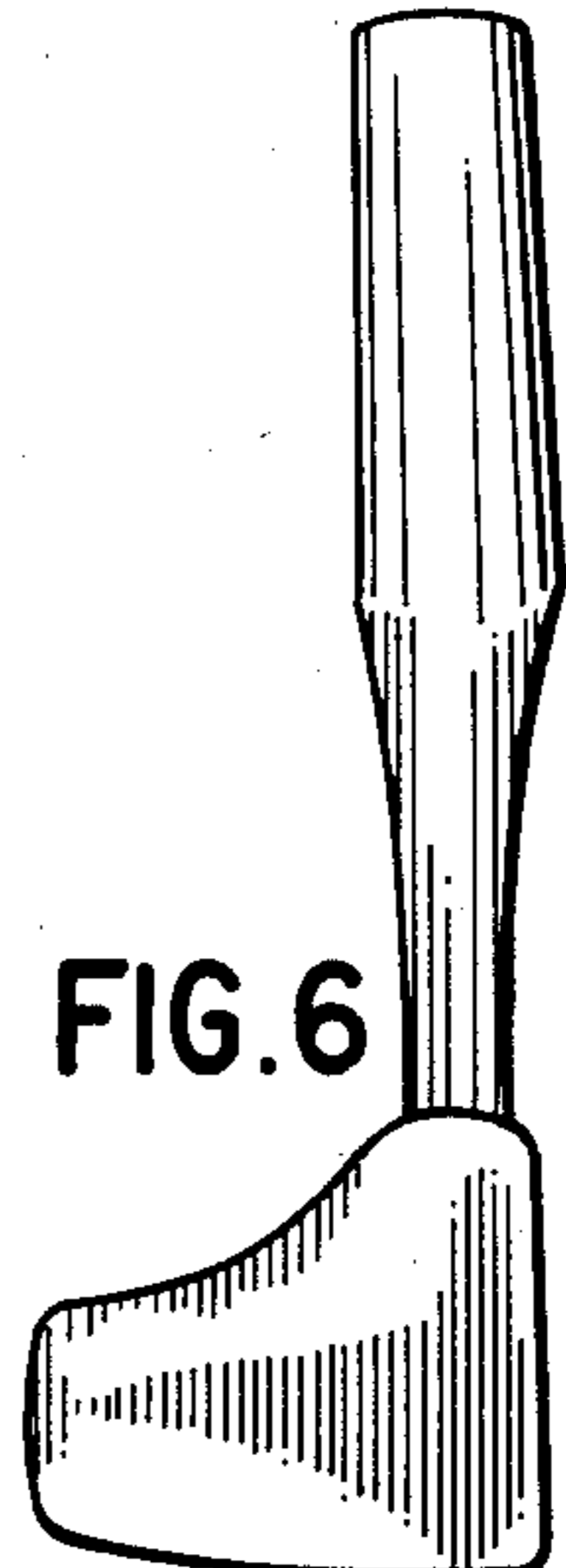

FIG. 6