

[54] CASSETTE HOLDER

[76] Inventor: Troy B. Bennett, 2607 Spruce St., Port Huron, Mich. 48060

[**] Term: 14 Years

[21] Appl. No.: 758,873

[22] Filed: Jul. 25, 1985

[52] U.S. Cl. D3/35; D3/73; D3/74

[58] Field of Search D3/35, 74, 73, 75, 78; 206/45, 13, 48, 18, 307, 309, 387, 389, 444, 312, 313, 472, 425; D6/407; D9/341, 423, 424, 432

[56] References Cited

U.S. PATENT DOCUMENTS

- D. 119,571 3/1940 Wykel et al. D3/74
- D. 144,533 4/1946 Worley D3/75
- D. 178,950 10/1956 Berry D3/75
- D. 210,869 4/1968 Hayes D9/423
- D. 221,193 7/1971 Goren D3/35
- D. 223,886 6/1972 Ferdinand D3/78

- D. 225,388 12/1972 Price D3/35
- D. 232,523 8/1974 Nudell D3/74
- D. 236,291 8/1975 Schurman D3/35
- D. 257,649 12/1980 Belgin .
- D. 259,154 5/1981 White D3/75
- D. 283,561 4/1986 Geist D3/74
- 3,294,222 12/1966 Hodgson D3/74 X
- 4,629,066 12/1986 Howard 206/387

Primary Examiner—Carmen H. Vales
Attorney, Agent, or Firm—W. C. Tupman

[57] CLAIM

The ornamental design for a cassette holder, as shown and described.

DESCRIPTION

FIG. 1 is a front elevational view of a cassette holder showing my new design;
 FIG. 2 is a rear elevational view thereof;
 FIG. 3 is a left side elevational view thereof;
 FIG. 4 is a right side elevational view thereof;
 FIG. 5 is a top plan view thereof;
 FIG. 6 is a bottom plan view thereof; and
 FIG. 7 is a perspective view in open position.

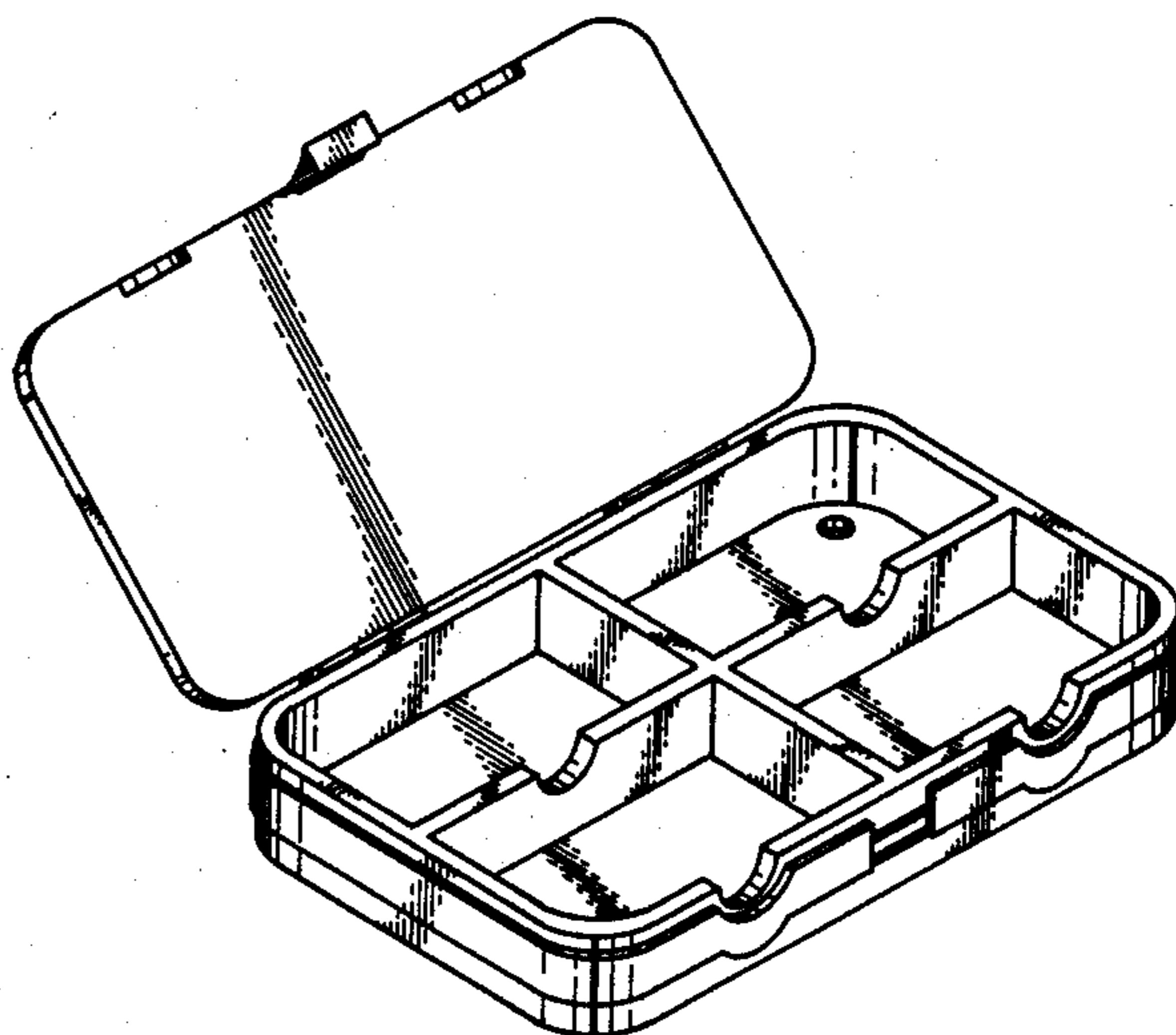
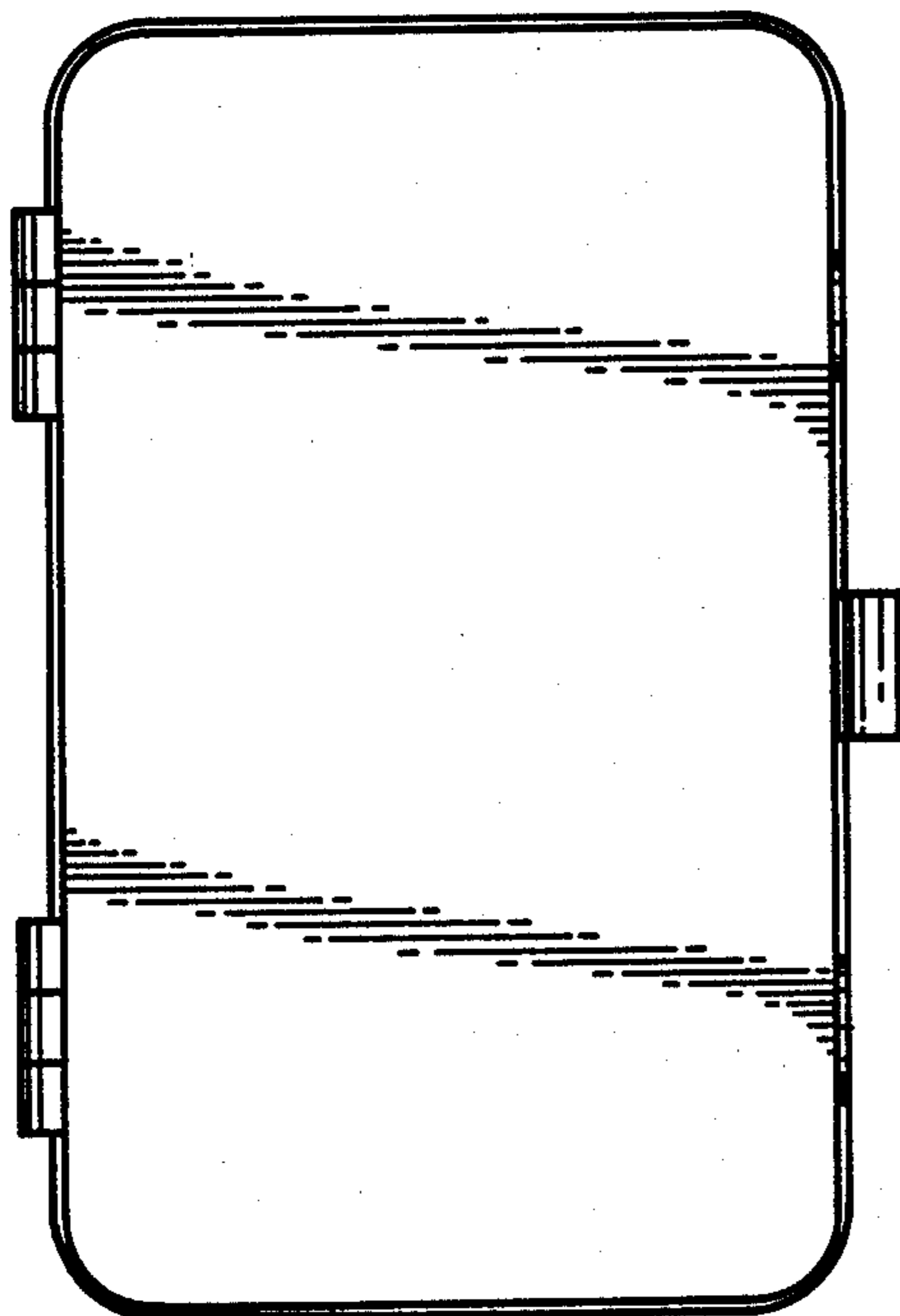

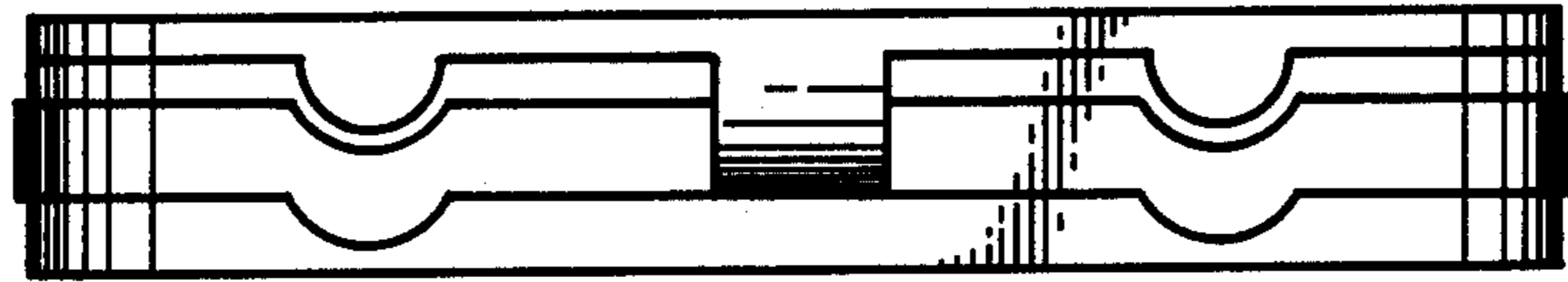

Fig. 1

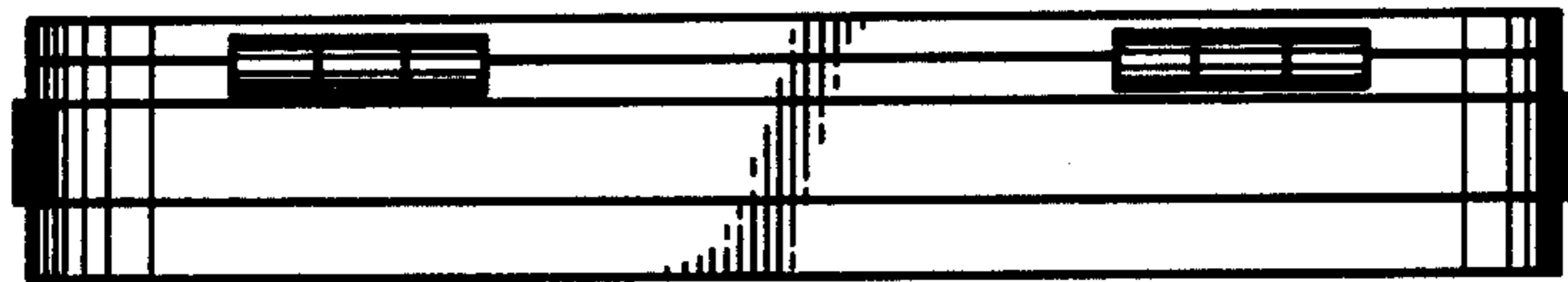

Fig. 2



Fig. 3

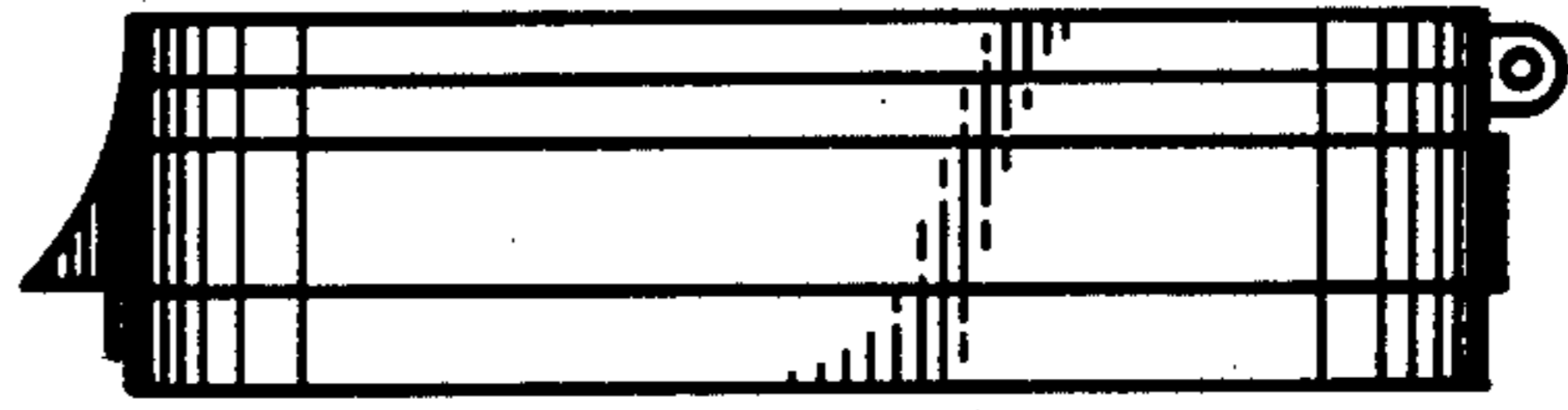

Fig. 4

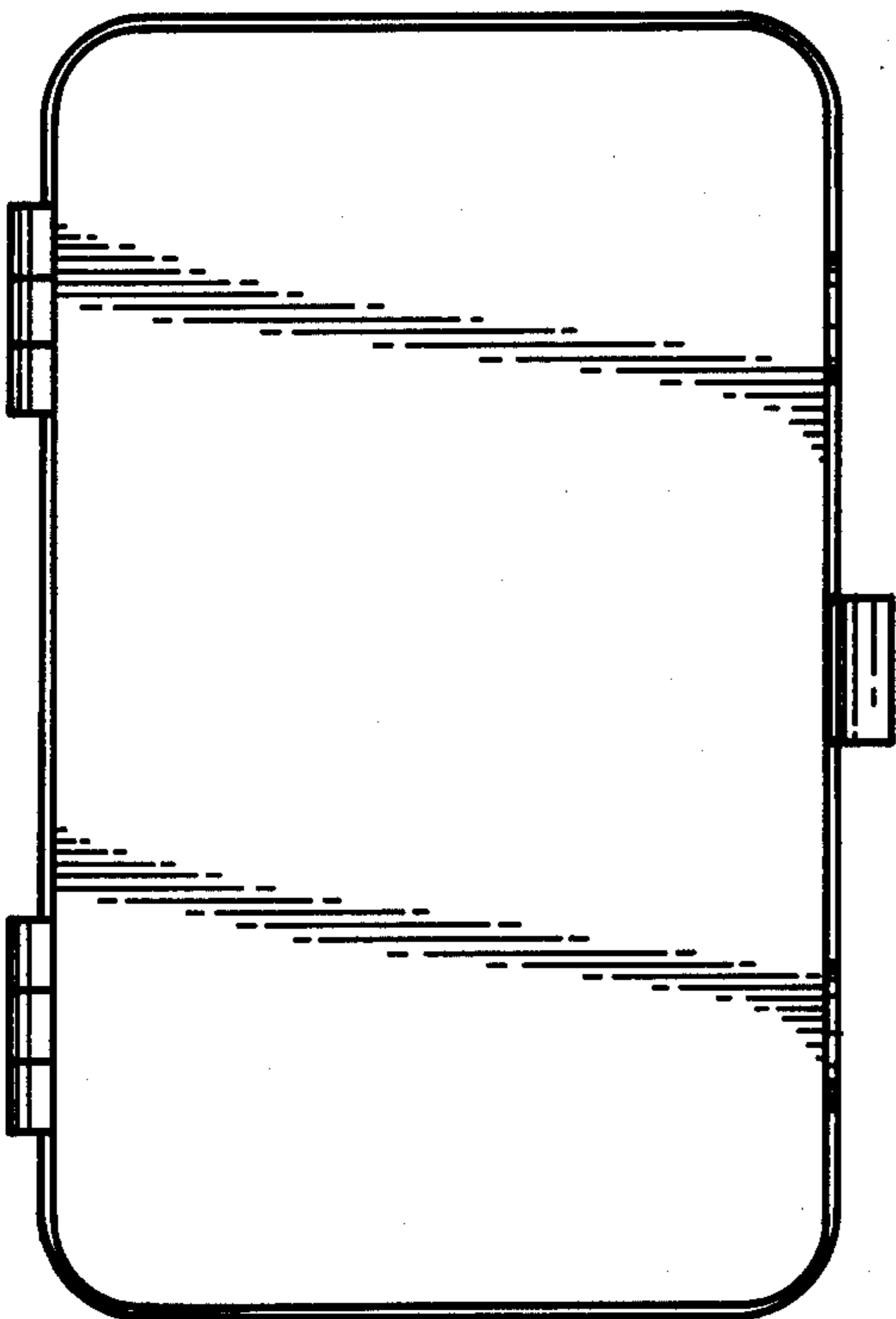

Fig. 5

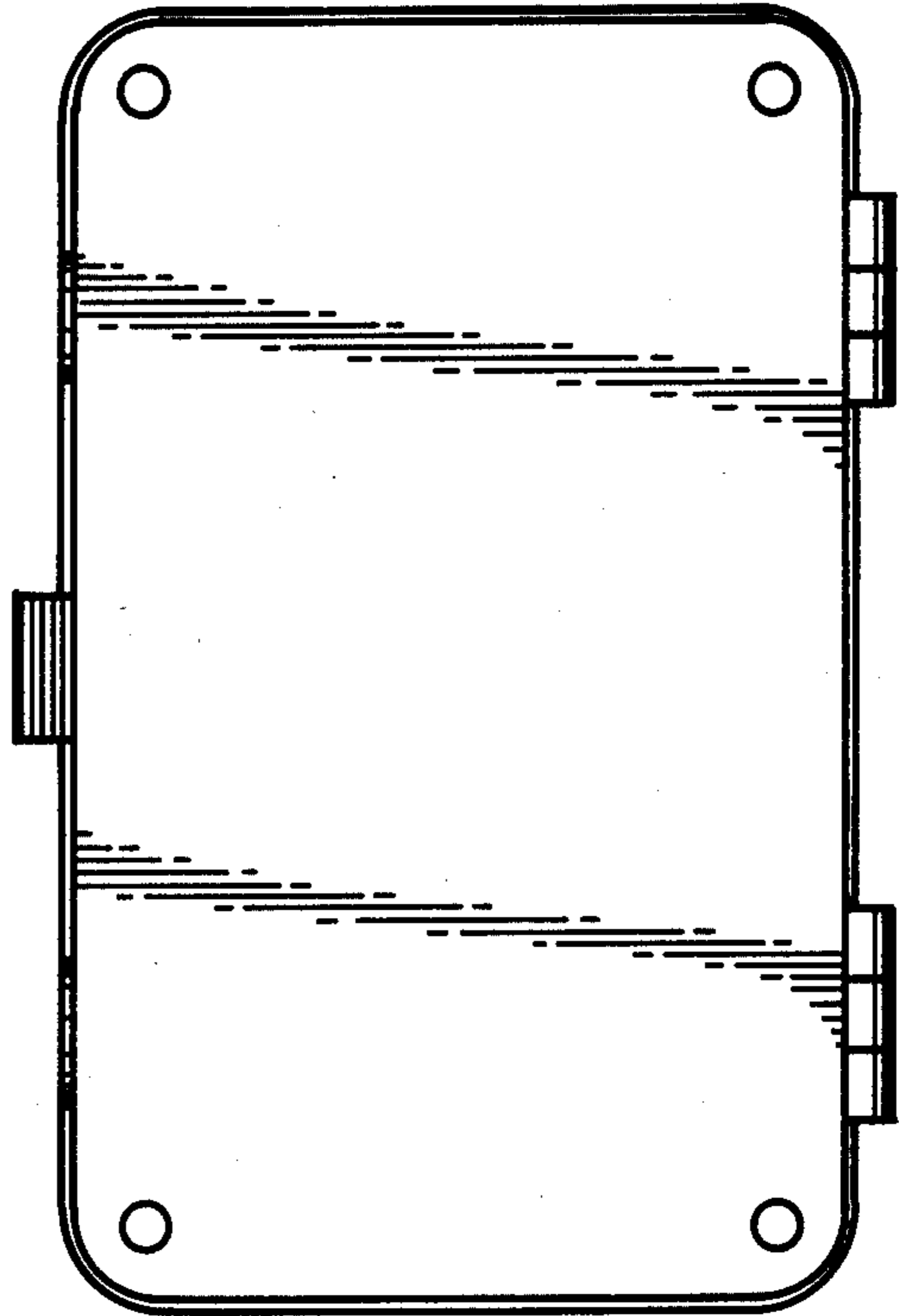

Fig. 6

