

[54] **VACUUM CLEANER**

[75] **Inventor: Loon Chui, Kwai Chung, Hong Kong**

[73] **Assignee: Joiner Electric Products Co. Ltd., Kwai Chung, Hong Kong**

[**] **Term: 14 Years**

[21] **Appl. No.: 810,183**

[22] **Filed: Dec. 18, 1985**

[30] **Foreign Application Priority Data**

Jul. 8, 1985 [GB] United Kingdom 1027797

[52] **U.S. Cl. D32/18**

[58] **Field of Search D32/17-18; 15/344, 412, 329, 361**

[56] **References Cited**

U.S. PATENT DOCUMENTS

D. 192,345	3/1962	Nerheim	D32/18
D. 200,092	1/1965	Polatchek	D32/18
D. 203,808	2/1966	Lagerstrom et al.	D32/18
D. 206,259	11/1966	Polatchek	D32/18
D. 207,443	4/1967	Gantz et al.	D32/18
D. 208,627	9/1967	Bonzer	D32/18
D. 209,274	11/1967	Richards et al.	D32/18
D. 211,396	6/1968	Hori	D32/18
D. 211,751	7/1968	Richards et al.	D32/18
D. 212,829	11/1968	Kraines	D32/18
D. 214,339	6/1969	Fosella	D32/18
D. 219,883	2/1971	Zijlstra	D32/18
D. 246,752	12/1977	Fukuda et al.	D32/18
D. 247,341	2/1978	Pelly	D32/18
D. 250,115	10/1978	Kawamura	D32/18
D. 253,452	11/1979	Tack	D32/18
D. 257,661	12/1980	Gantz	D32/18
D. 259,618	6/1981	Tack	D32/17

D. 262,258	12/1981	Doyel	D32/18
D. 274,381	6/1984	Chiu	D32/18
D. 275,427	9/1984	Kishi et al.	D32/18
D. 277,706	2/1985	Wareham	D32/18
D. 278,278	4/1985	McCloskey	D32/18
D. 278,942	5/1985	Chiu	D32/18
D. 279,513	7/1985	Rinaldi et al.	D32/18
D. 280,452	9/1985	Arita	D32/18
D. 280,453	9/1985	Tsuji	D32/18
D. 283,064	3/1986	Thomas et al.	D32/18
D. 287,419	12/1986	Ling	D32/18
D. 289,576	4/1987	Okada et al.	D32/18
2,972,160	2/1961	Hahn	15/344
3,513,500	5/1790	Hori	15/344
4,011,624	4/1977	Proett	15/344
4,573,234	3/1986	Kochte et al.	15/344
4,573,237	3/1986	Kochte et al.	15/414

FOREIGN PATENT DOCUMENTS

1453075	2/1969	Fed. Rep. of Germany .
2046130	3/1972	Fed. Rep. of Germany .

Primary Examiner—Wallace R. Burke
Assistant Examiner—Ruth Takemoto
Attorney, Agent, or Firm—Saidman, Sterne, Kessler & Goldstein

[57] **CLAIM**

The ornamental design for a vacuum cleaner, as shown and described.

DESCRIPTION

FIG. 1 is a top, front and left side perspective view of a vacuum cleaner showing my new design;
 FIG. 2 is a top, rear and left side perspective view thereof;
 FIG. 3 is a left side elevational view thereof;
 FIG. 4 is a right side elevational view thereof;
 FIG. 5 is a top plan view thereof; and
 FIG. 6 is a bottom plan view thereof.

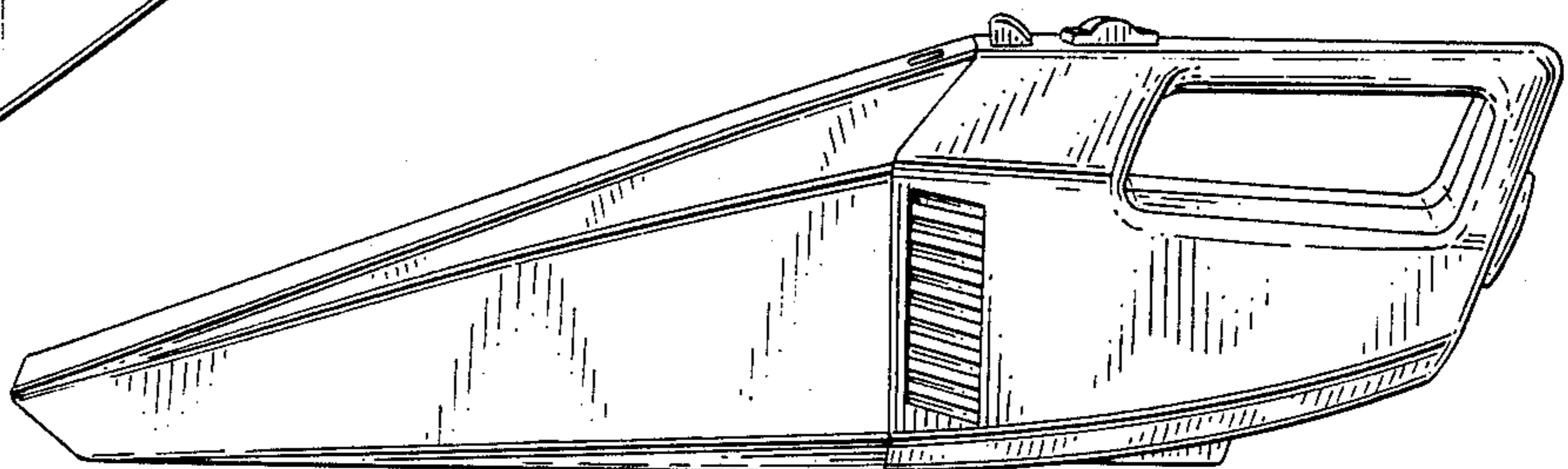
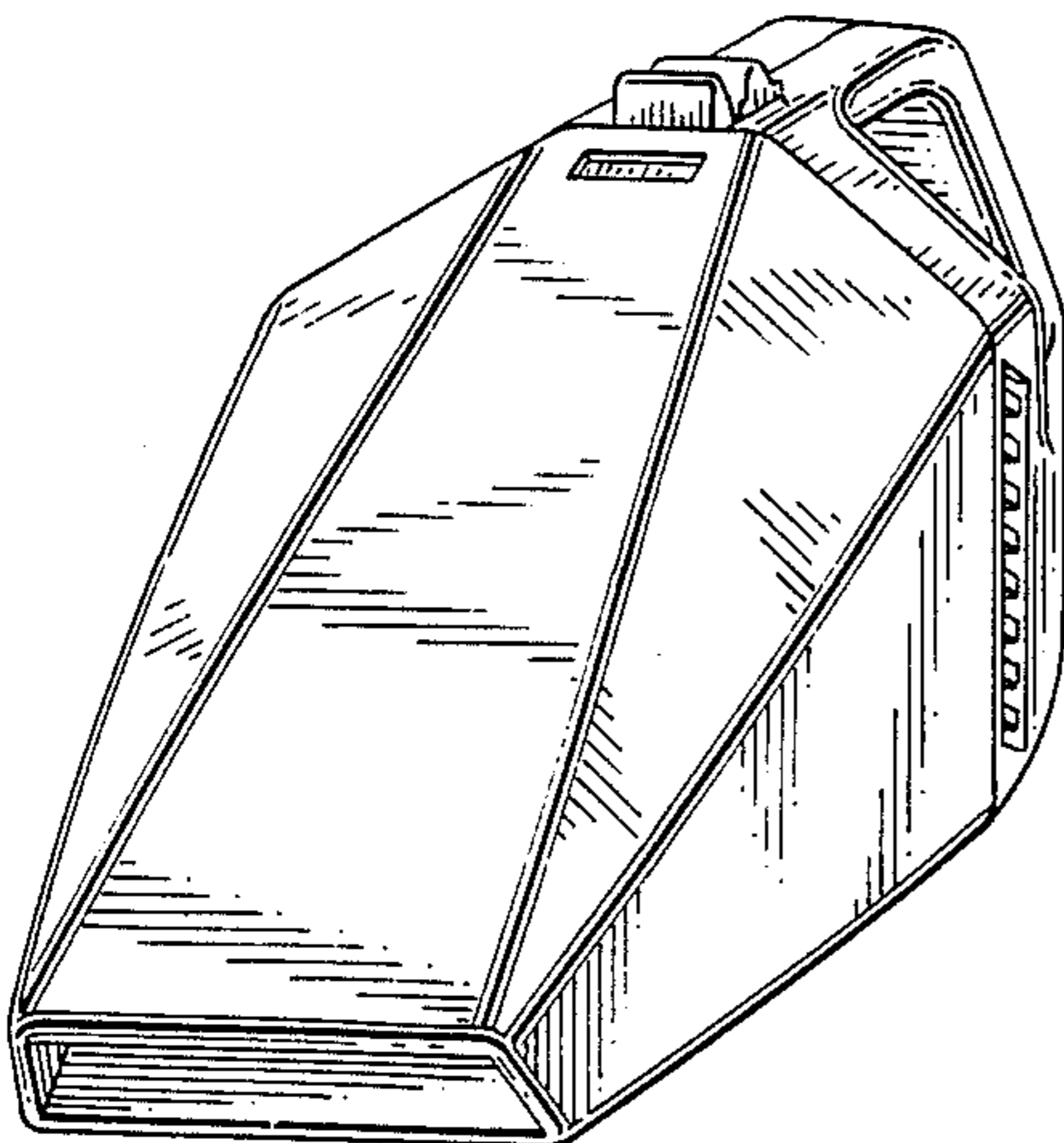

FIG. 1

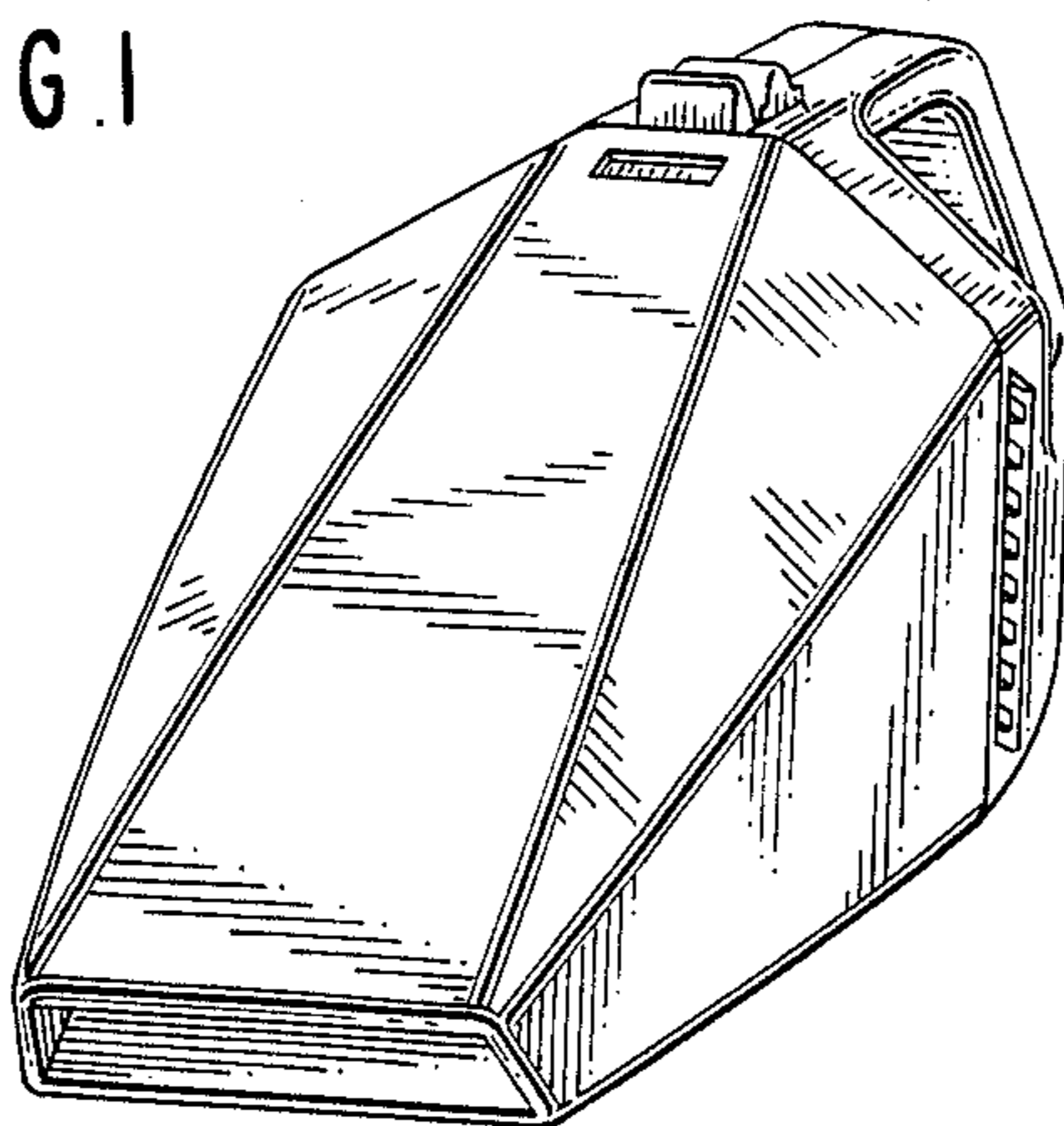

FIG. 2

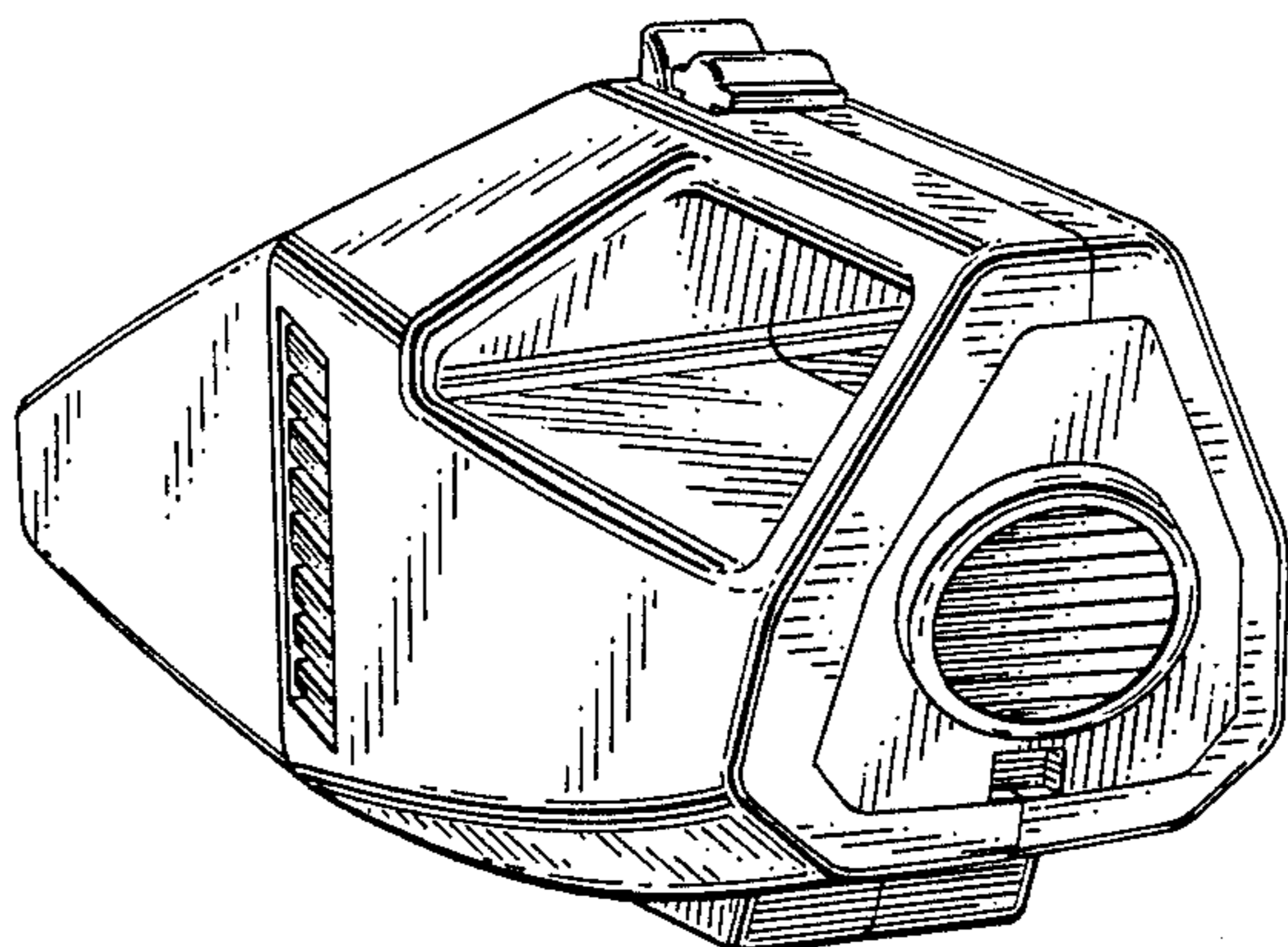

FIG. 3

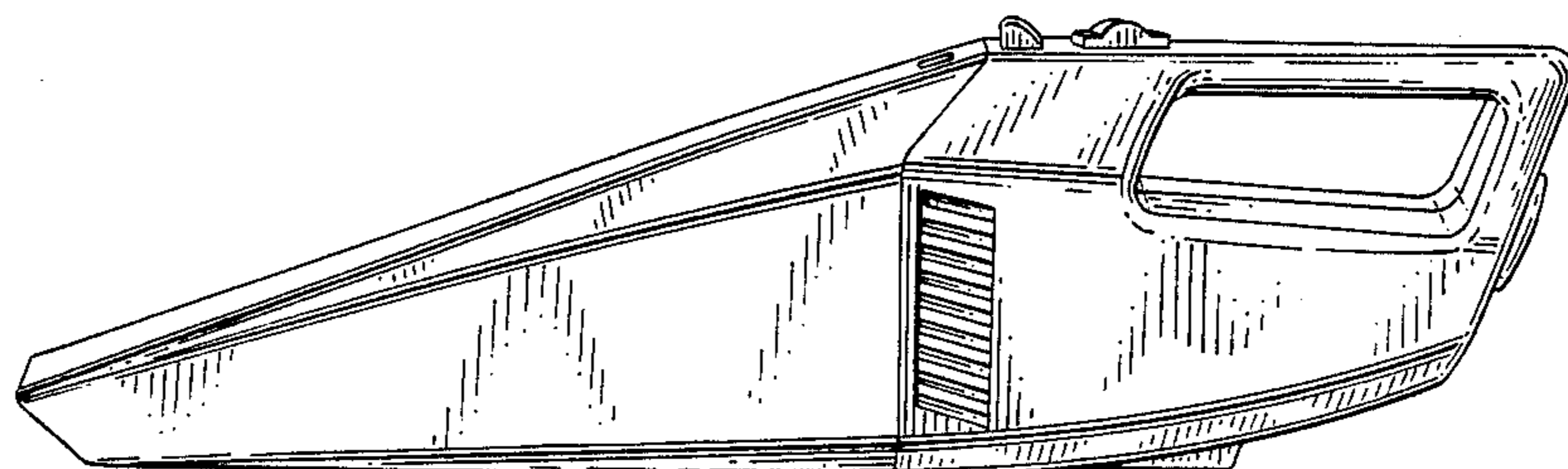

FIG. 4

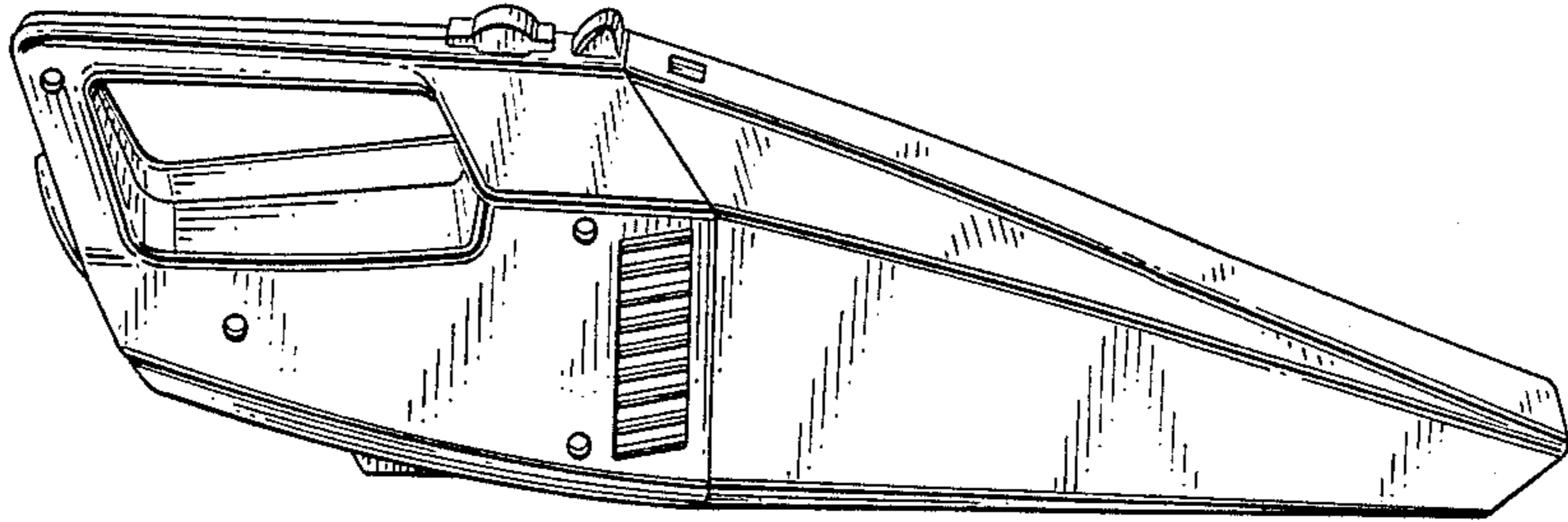

FIG. 5

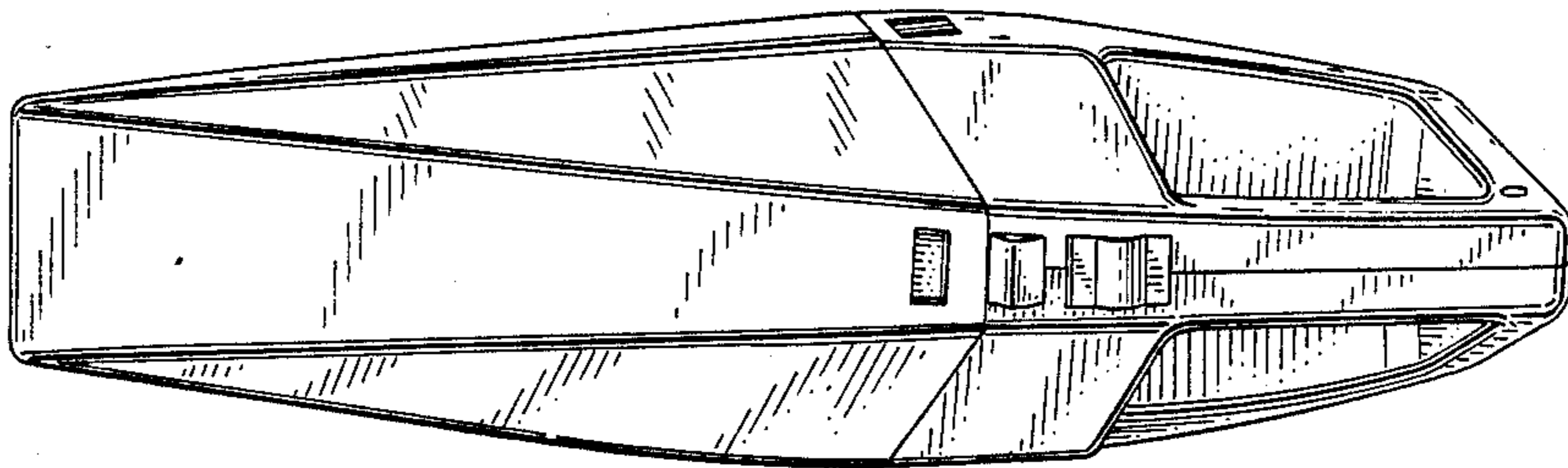

FIG. 6

