

[54] KEY PAD

4,564,751 1/1986 Alley et al. .... 364/708 X

[75] Inventor: W. Andrew Morrison, Saratoga, Calif.

Primary Examiner—Susan J. Lucas  
Attorney, Agent, or Firm—Fliesler, Dubb, Meyer & Lovejoy

[73] Assignee: Thumbscan, Inc., Oakbrook Terrace, Ill.

[57] CLAIM

[\*\*] Term: 14 Years

The ornamental design for a key pad, as shown and described.

[21] Appl. No.: 810,396

DESCRIPTION

[22] Filed: Dec. 17, 1985

FIG. 1 is a bottom, front, and right side isometric view of a keypad showing my new design;

[52] U.S. Cl. .... D14/114

FIG. 2 is a front elevational view thereof on a reduced scale;

[58] Field of Search ..... D14/100, 106, 107, 114;  
D18/7; 364/708; 340/700, 711, 710, 709, 706,  
365 R, 365 UL; 235/145 R, 146; 200/5 R, 5 A;  
D13/12, 32, 38

FIG. 3 is a top plan view thereof on a reduced scale;  
FIG. 4 is a left hand side elevational view thereof on a reduced scale;

[56] References Cited

U.S. PATENT DOCUMENTS

- D. 283,895 5/1986 Grimes ..... D14/114
- D. 286,047 10/1986 Roots et al. .... D14/100

FIG. 5 is a right hand side elevational view thereof on a reduced scale;

FIG. 6 is a bottom plan view thereof on a reduced scale;

FIG. 7 is a rear elevational view thereof on a reduced scale.

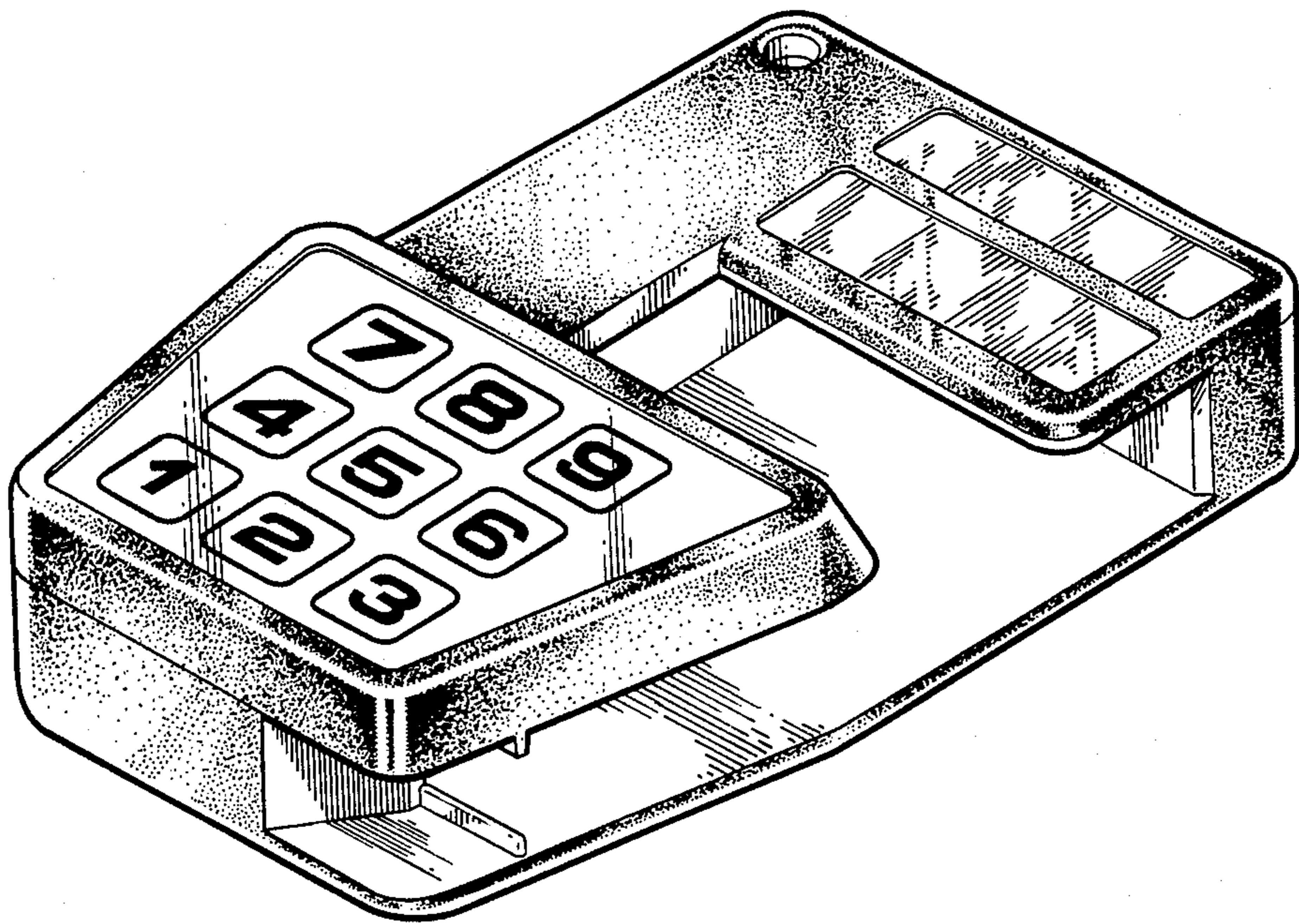
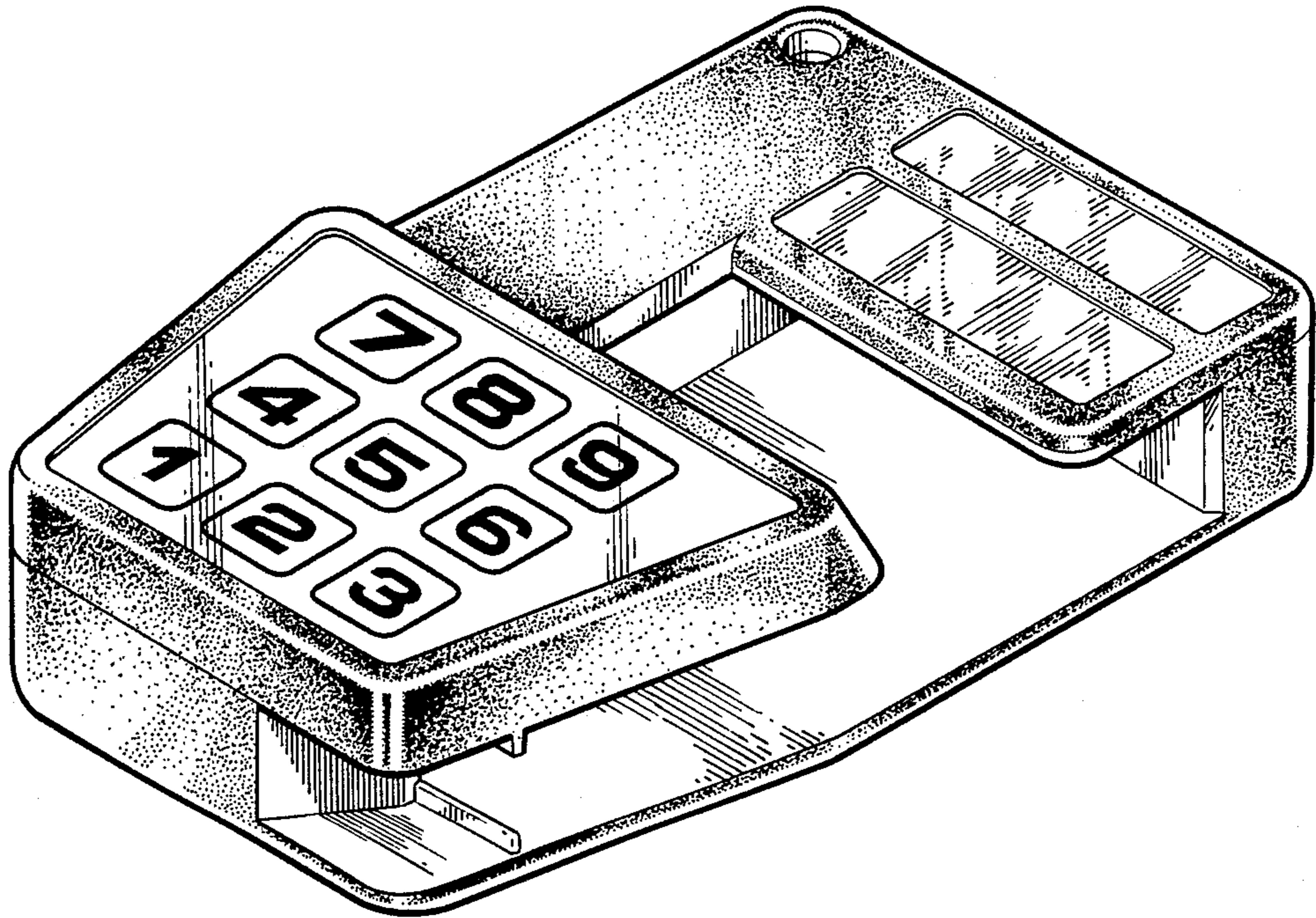

FIGURE 1



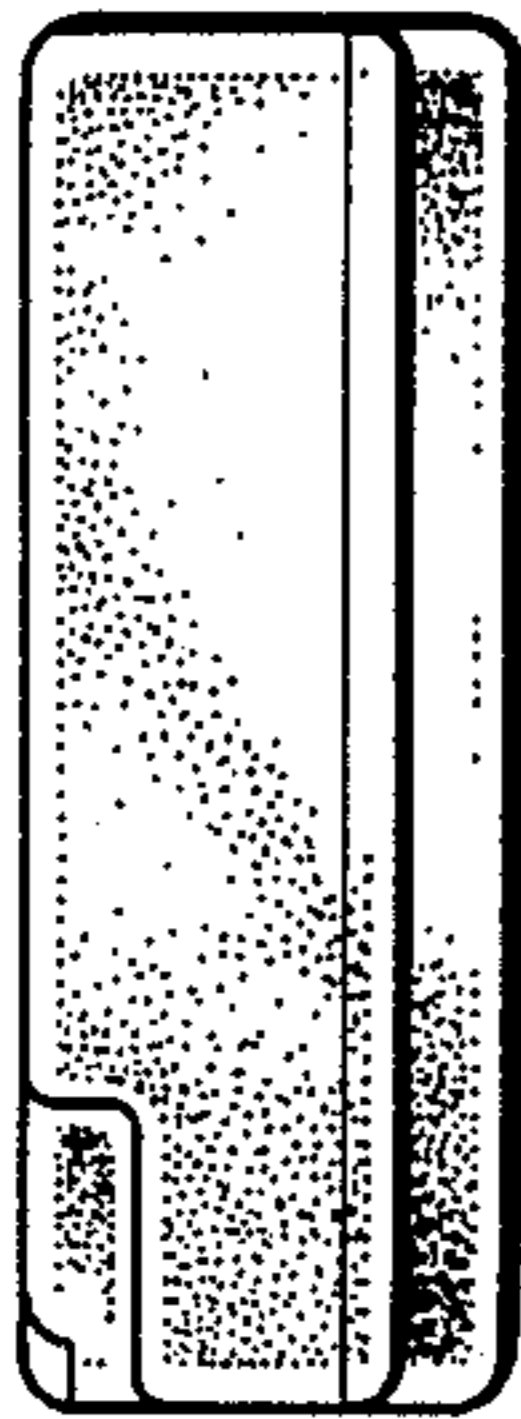

FIGURE 3

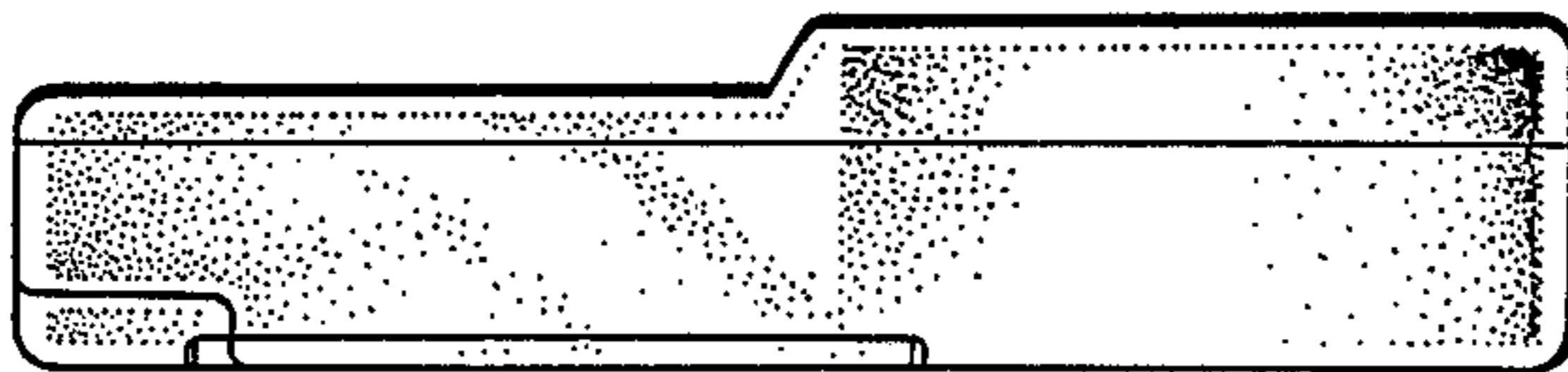

FIGURE 4

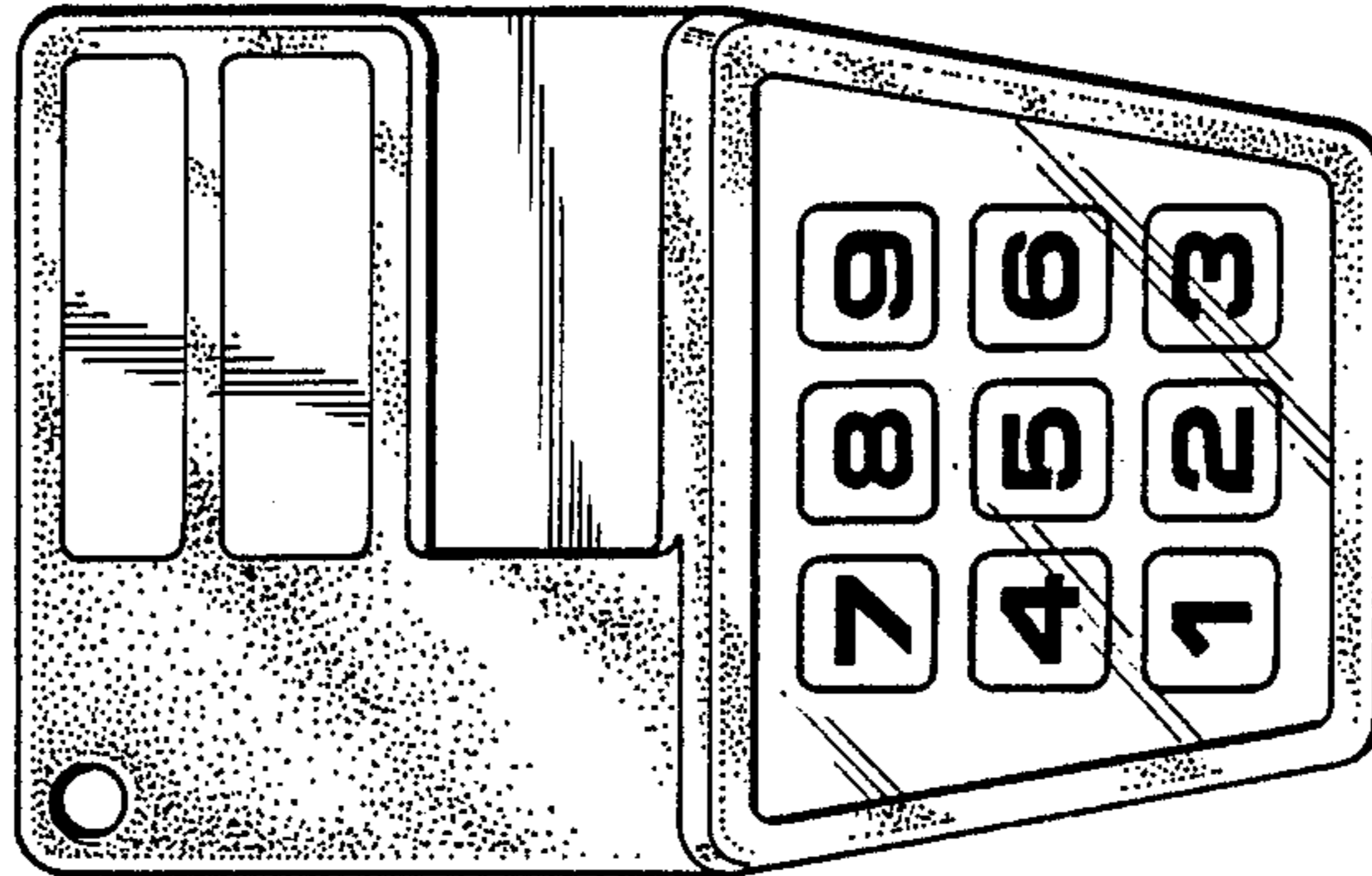

FIGURE 2

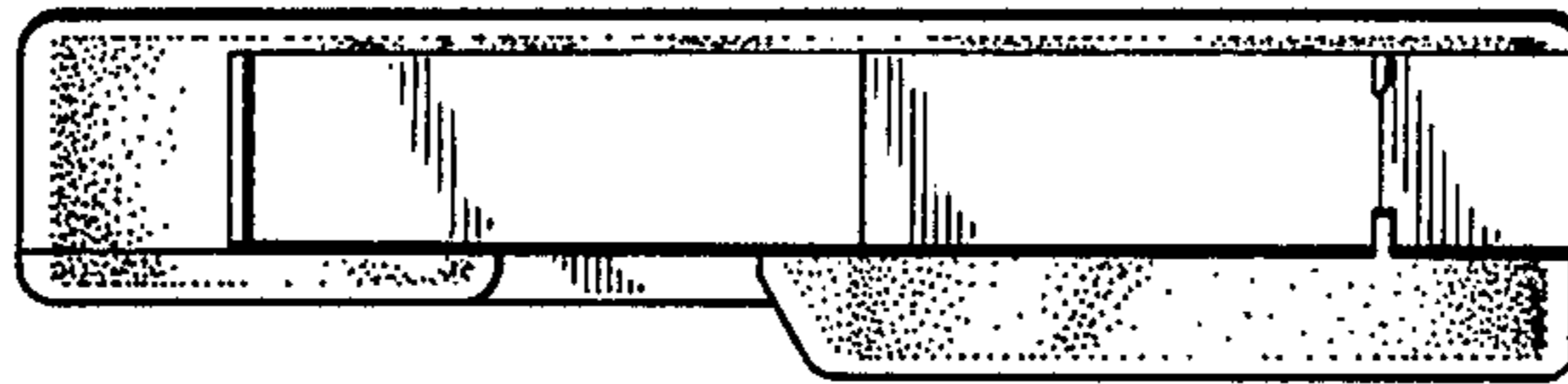

FIGURE 5

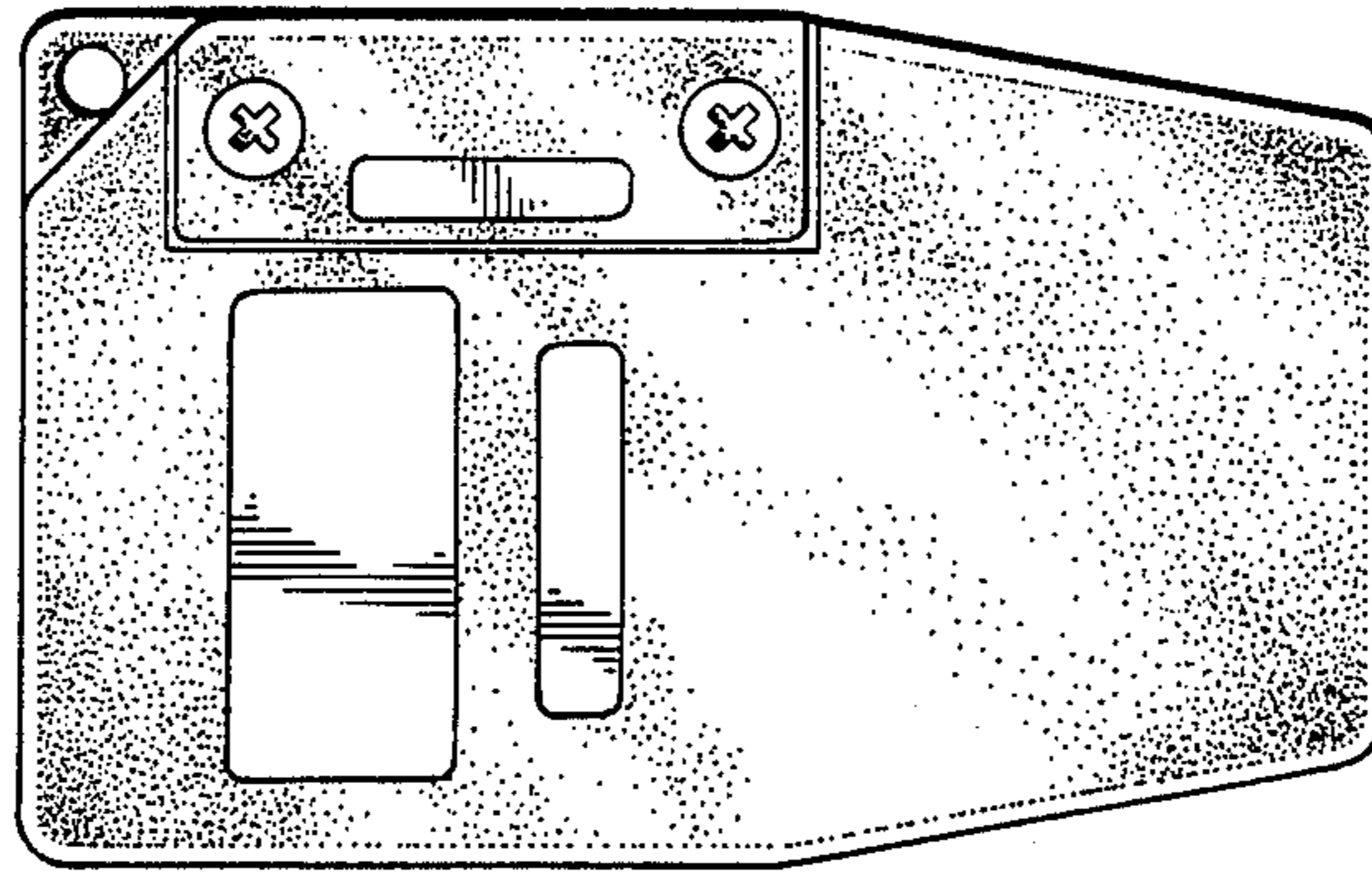

FIGURE 7

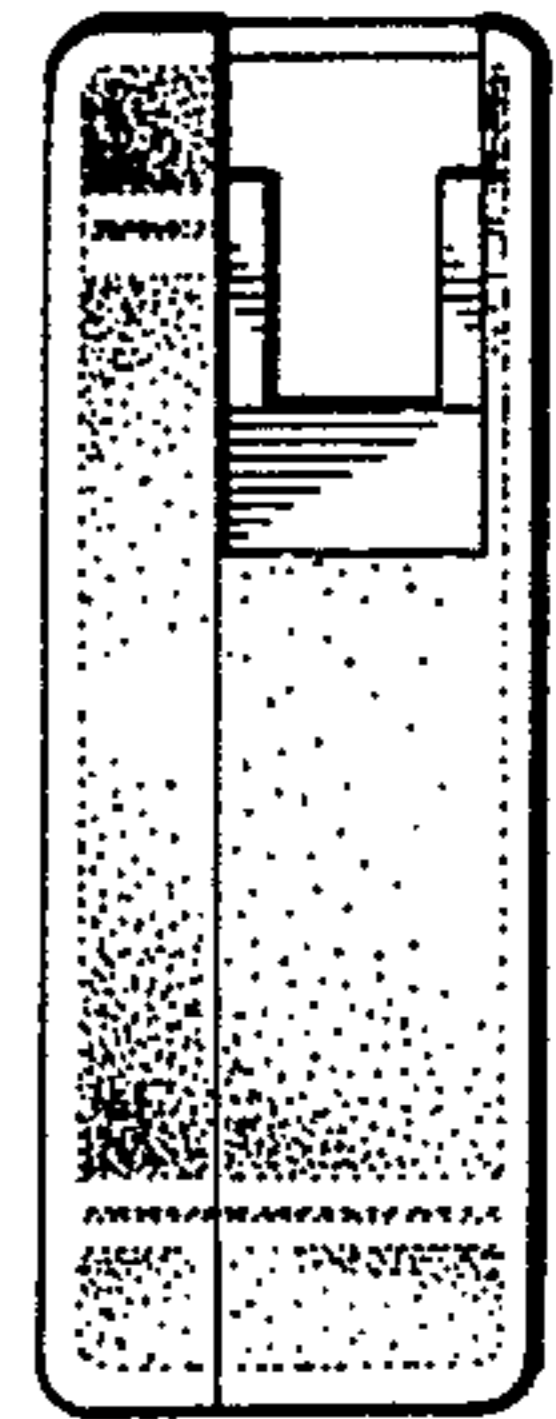

FIGURE 6