

[54] SMOKE AND FIRE ALARM

Primary Examiner—Catherine E. Kemper

[76] Inventor: Howard L. Rauch, Old Saybrook, Conn.

[57] CLAIM

[\*\*] Term: 14 Years

The ornamental design for a smoke and fire alarm, as shown and described.

[21] Appl. No.: 811,563

DESCRIPTION

[22] Filed: Dec. 20, 1985

[52] U.S. Cl. .... D10/106

[58] Field of Search ..... D10/104, 106, 121; 340/628, 629, 630, 695

FIG. 1 is a front elevational view of a smoke and fire alarm showing my new design; FIG. 2 is a bottom plan view thereof; FIG. 3 is a rear elevational view thereof; FIG. 4 is a left side elevational view thereof; FIG. 5 is a top plan view thereof; and FIG. 6 is a right side elevational view thereof; FIG. 7 is a front elevational view of a second embodiment of a smoke and fire alarm; FIG. 8 is a bottom plan view thereof; FIG. 9 is a rear elevational view thereof; FIG. 10 is a left side elevational view, the right side being a mirror image thereof; FIG. 11 is a top plan view thereof.

[56] References Cited

U.S. PATENT DOCUMENTS

D. 247,665	4/1978	Larsen	.....	D10/121
D. 253,400	11/1979	Vander Wilt	.....	D10/106
D. 262,868	2/1982	Westphal	.....	D10/106
D. 271,287	11/1983	Fenne	.....	D10/106
D. 276,417	11/1984	Fenne	.....	D10/106
D. 279,769	7/1985	Thornton et al.	.....	D10/106
D. 283,407	4/1986	Fenne	.....	D10/106

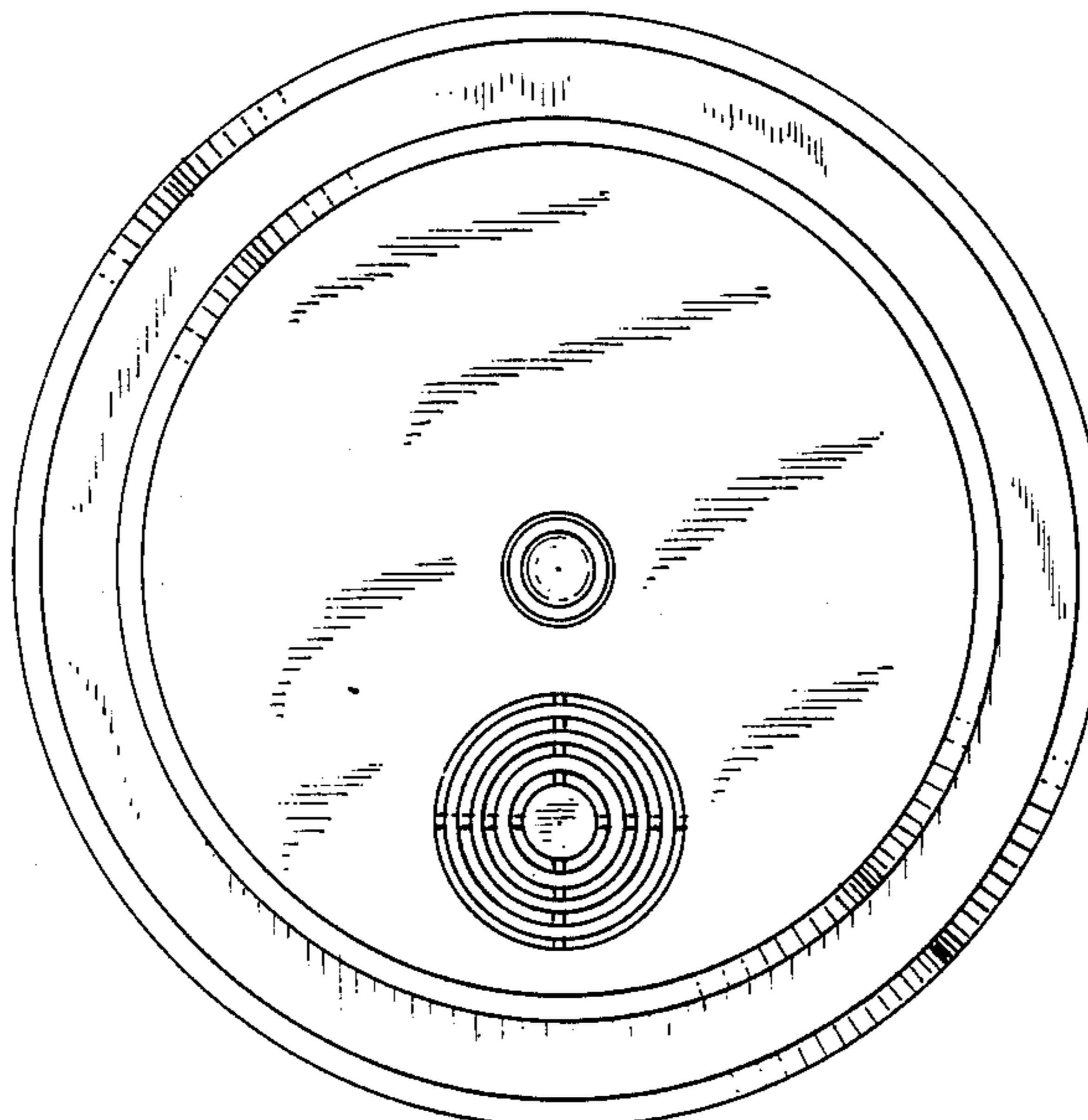
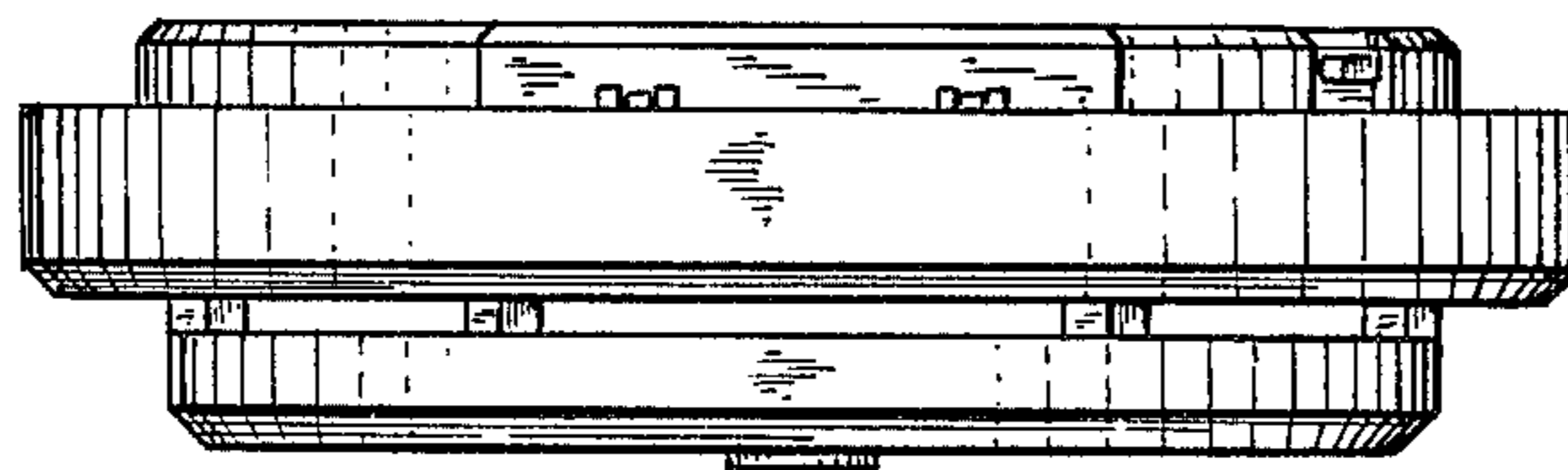

FIG. 1

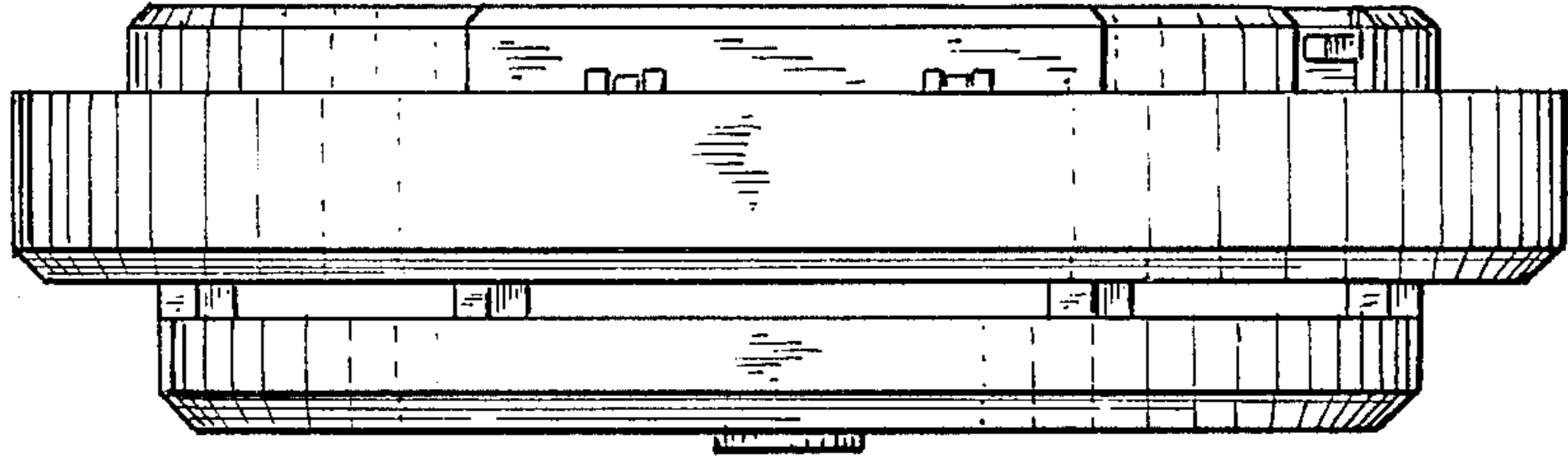

FIG. 2

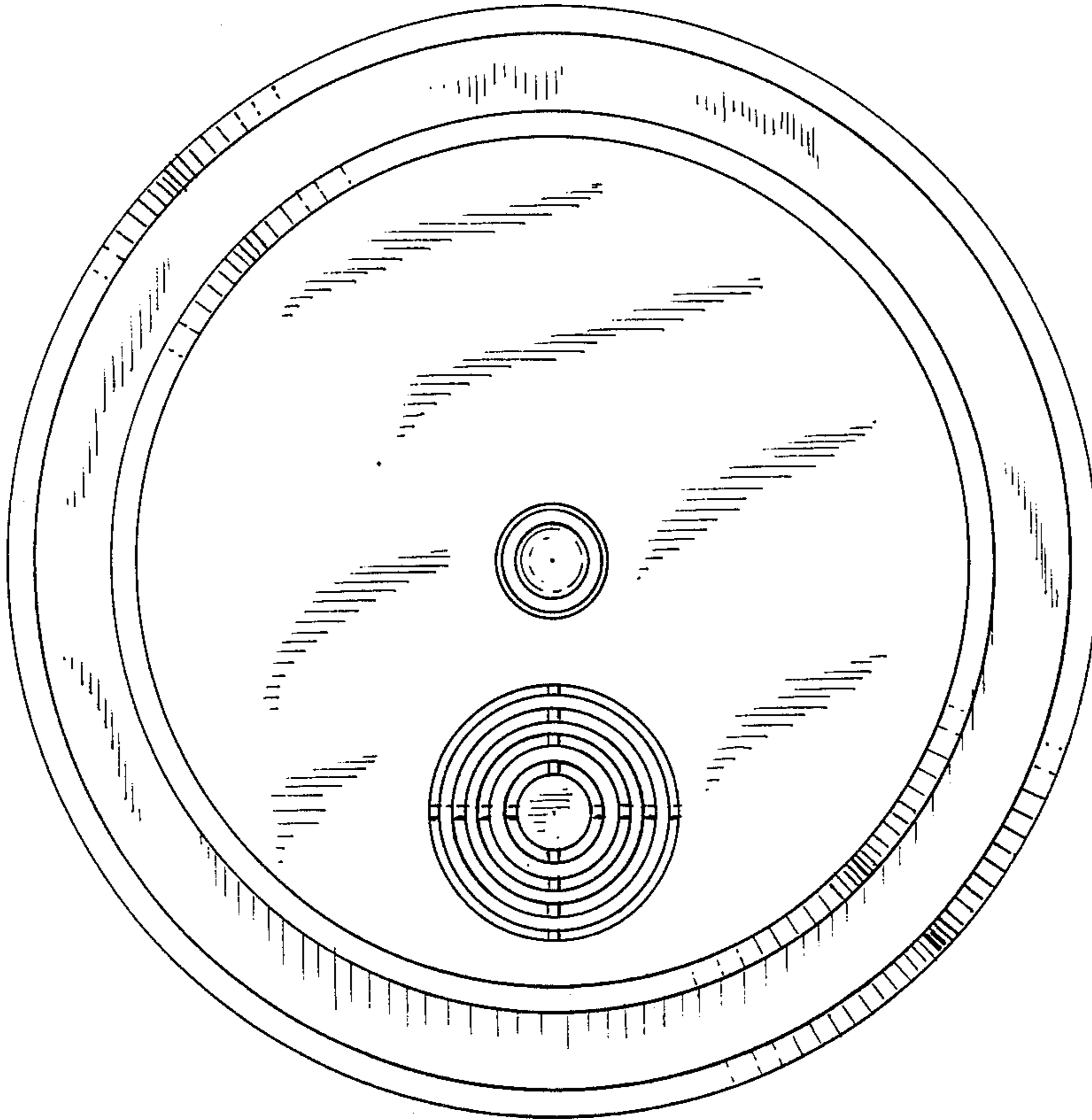

FIG. 3

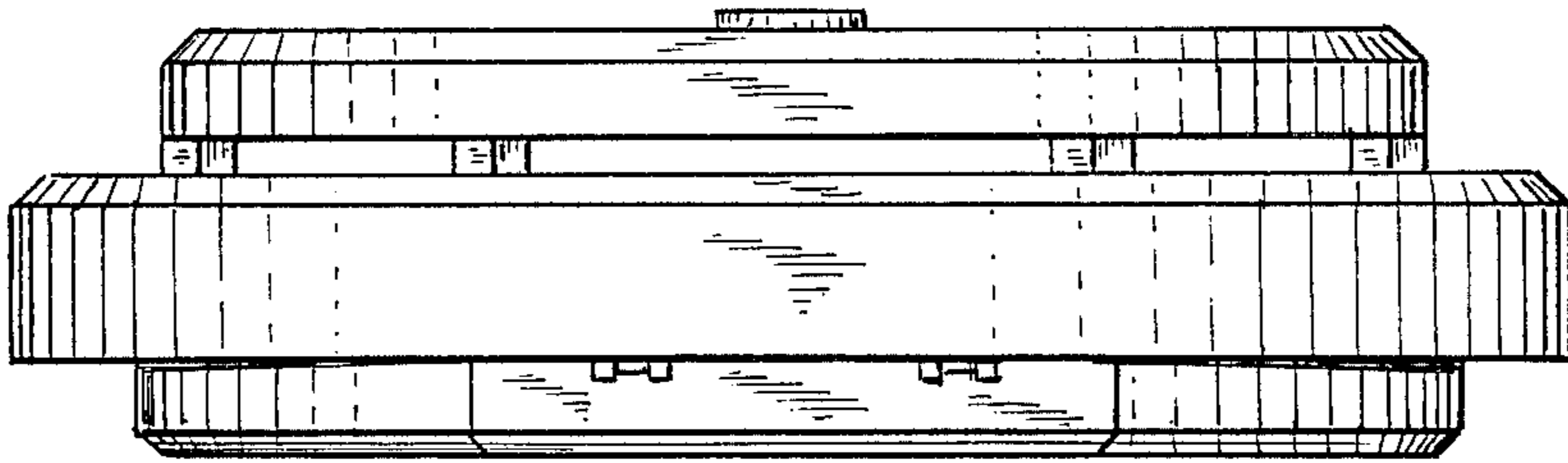

FIG. 6

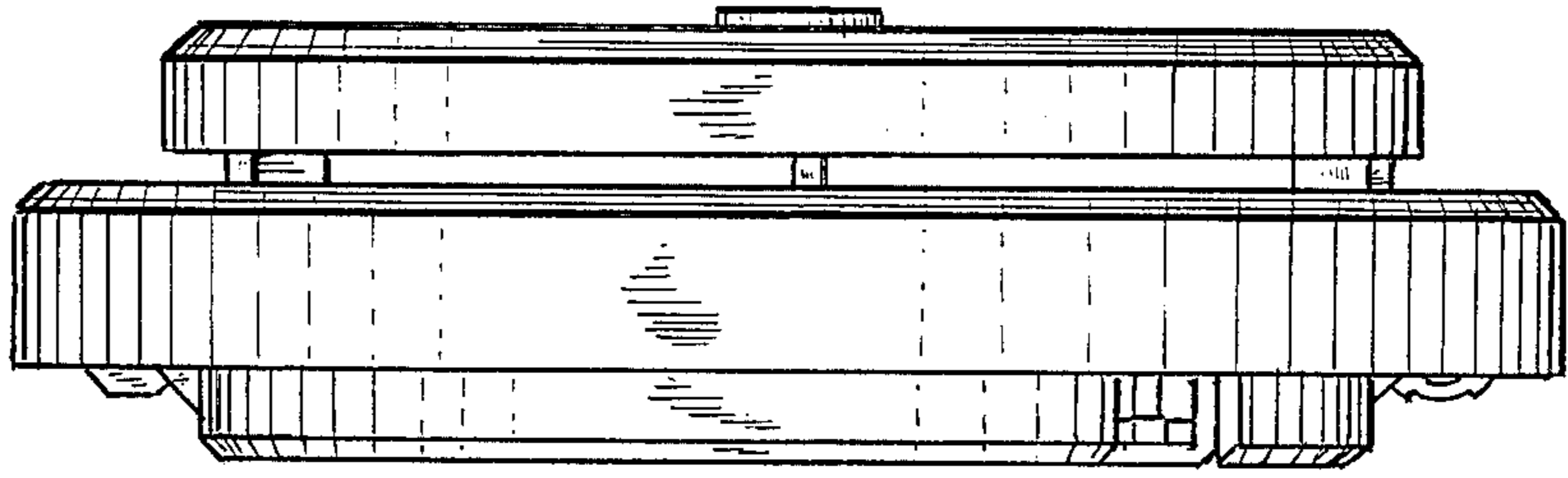

FIG. 5

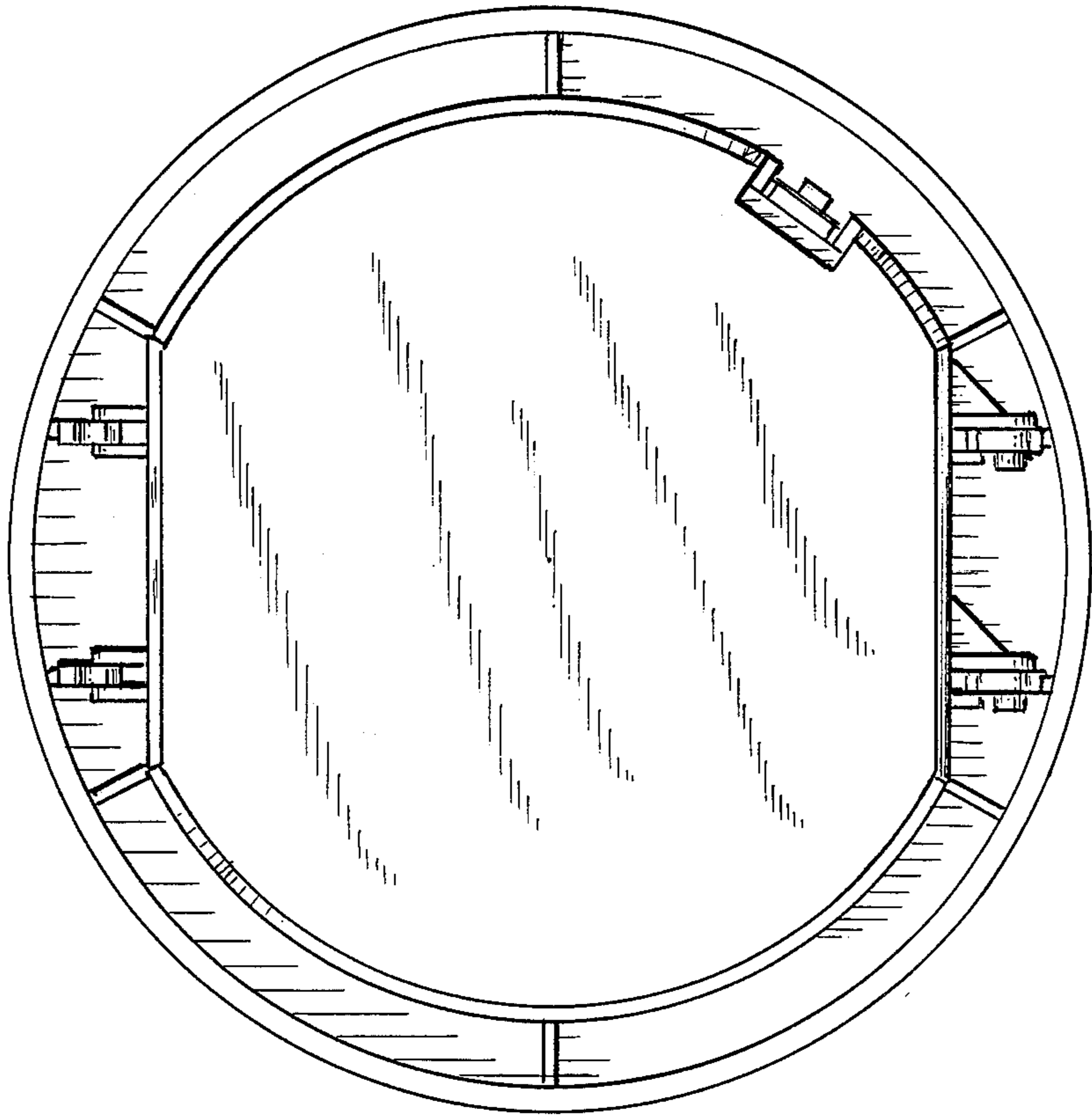

FIG. 4

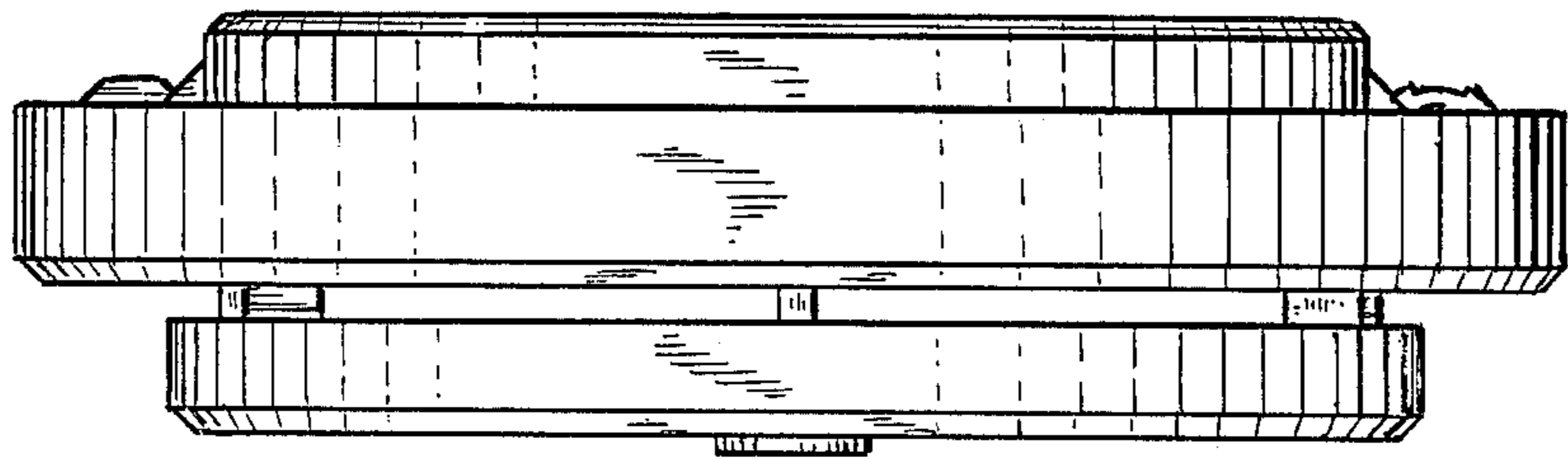

FIG. 7

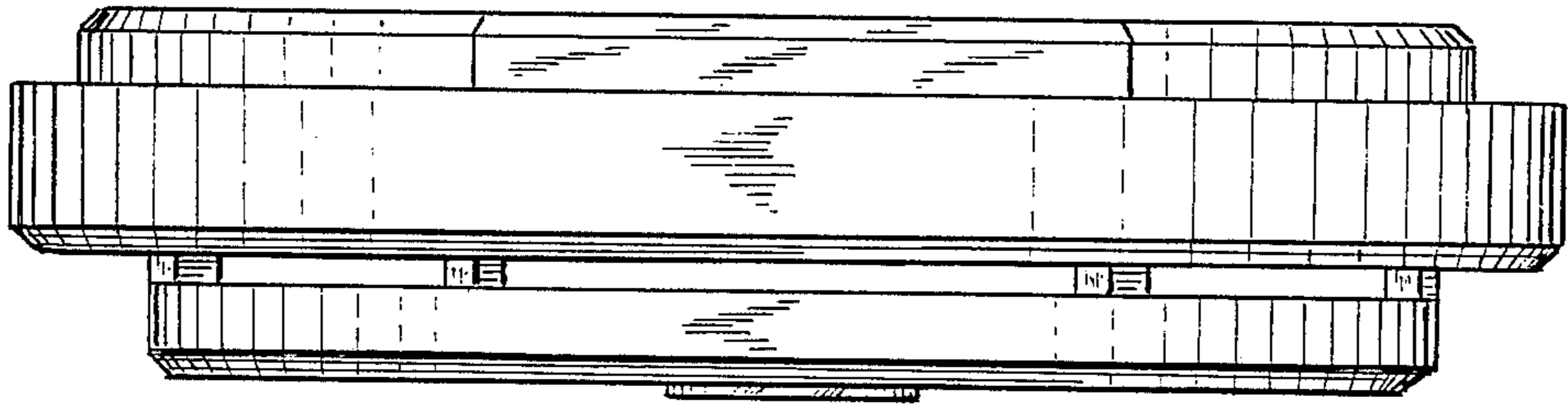

FIG. 8

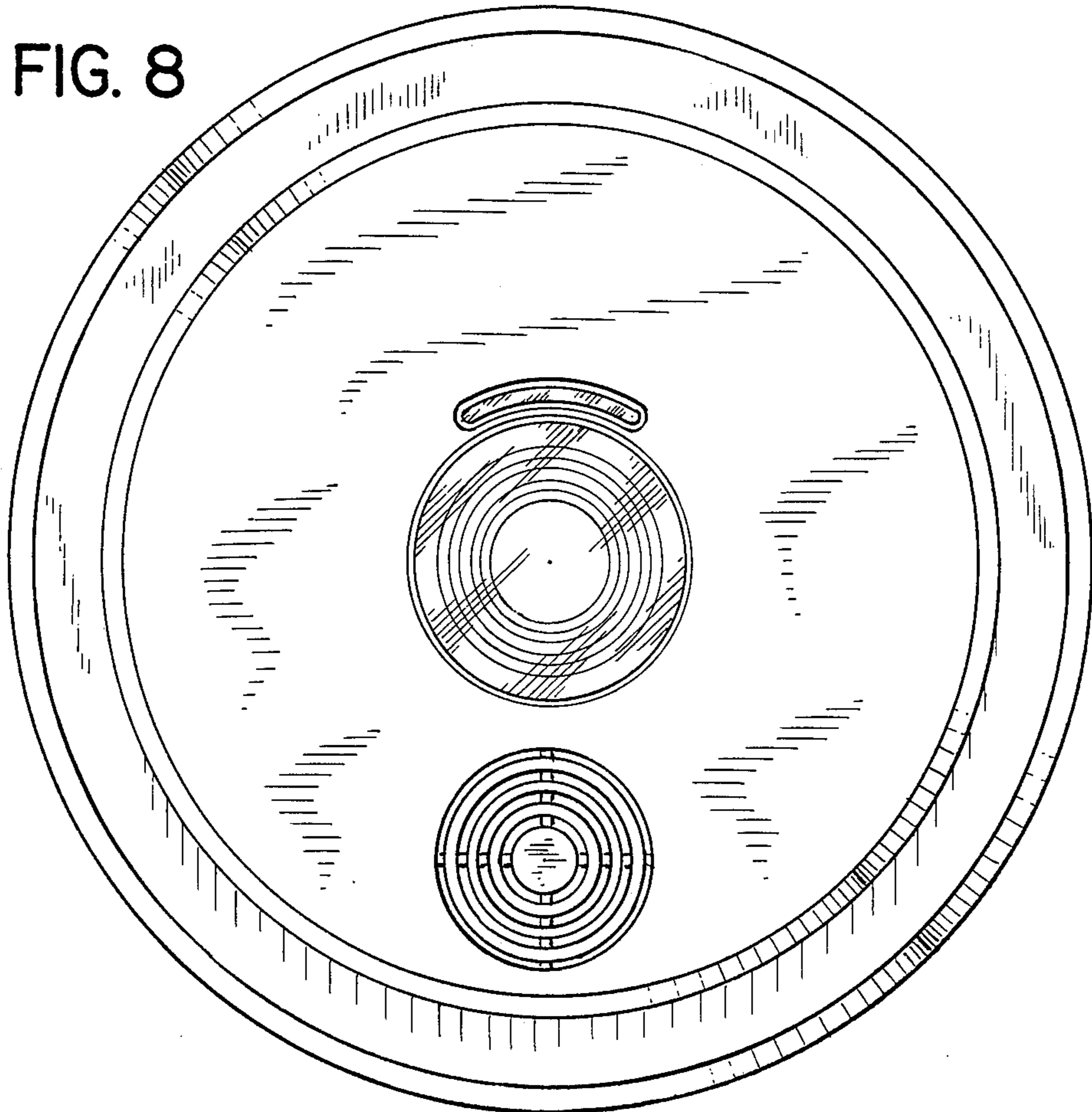

FIG. 9

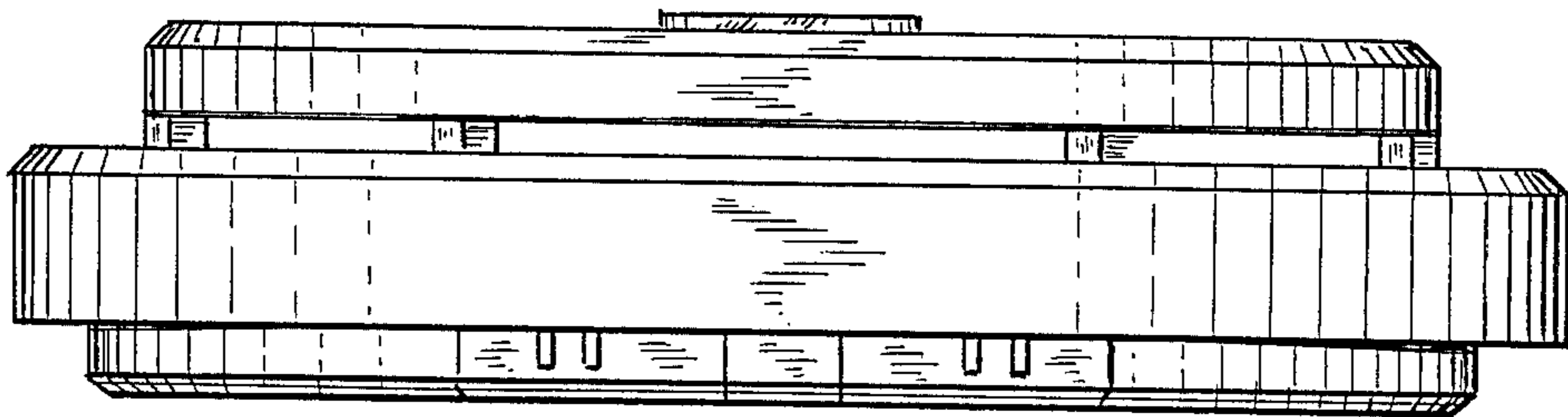

FIG. 11

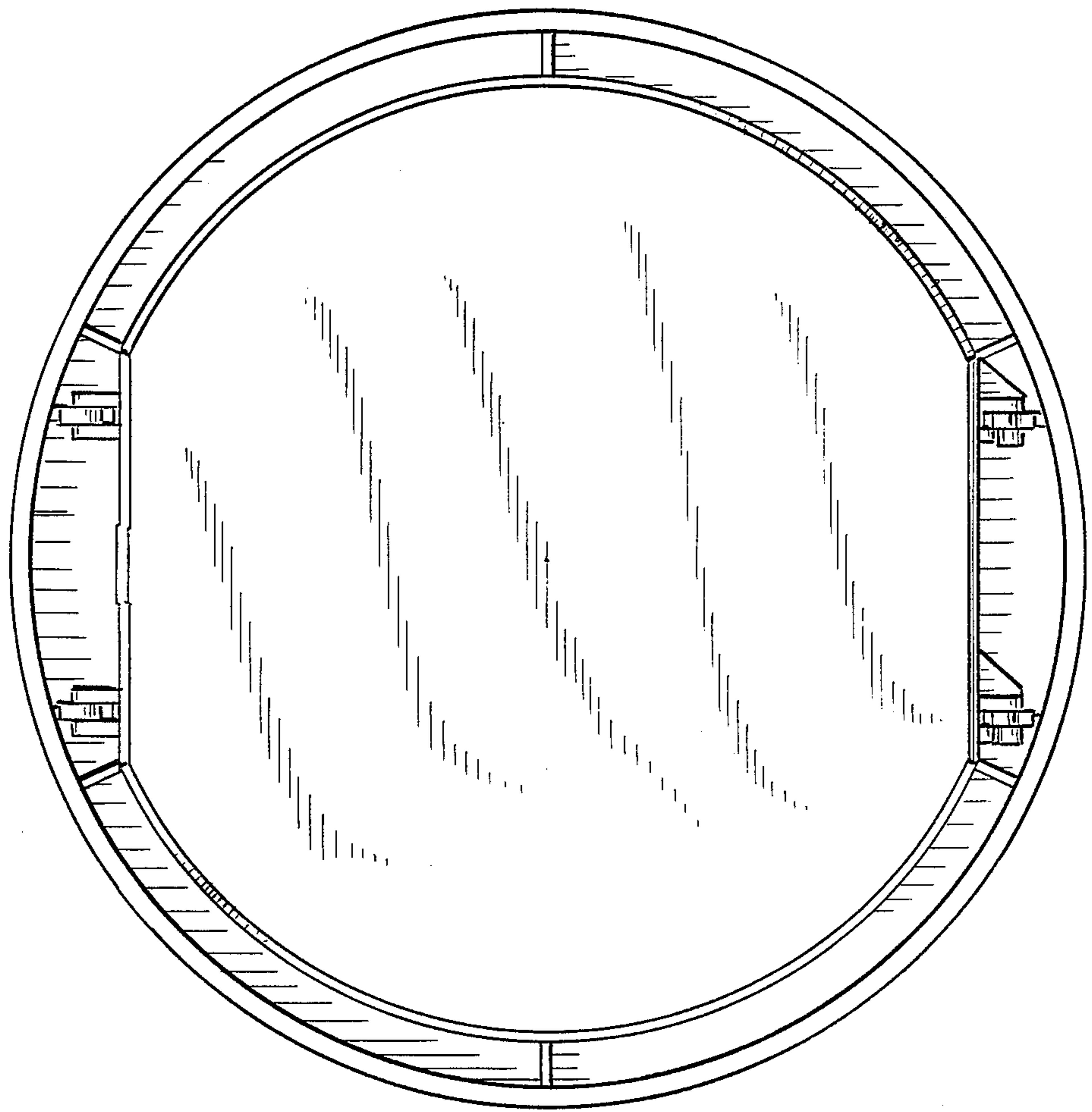

FIG. 10

