

[54] SIMULATED COMPUTER SYSTEM

[76] Inventor: Ray W. Milliman, c/o Proptronics Co., 350 Wainwright, Northbrook, Ill. 60062

[**] Term: 14 Years

[21] Appl. No.: 695,567

[22] Filed: Jan. 28, 1985

[52] U.S. Cl. D14/100

[58] Field of Search D14/100, 101, 106, 107, D14/114, 115; D20/29, 99; D10/104; 272/8 N

[56] References Cited

U.S. PATENT DOCUMENTS

- D. 226,198 1/1973 King D14/100
- D. 270,158 8/1983 Fossella et al. D14/106

OTHER PUBLICATIONS

- Office Administration and Automation, 10-1983, p. 78, Text-Editing Machine System.
- Office Administration and Automation, 10-1983, p. 84, Olympia Display Terminal.
- Personal Computing, 11-1983, p. 324, Com-Star T/F Printer.
- Today's Office, 2-1983, p. 1, Motorola Disk Drive.

Virco® Data Stations brochure, 1983, p. 12, Keyboard.

Primary Examiner—Susan J. Lucas

[57] CLAIM

The ornamental design for a simulated computer system, as shown and described.

DESCRIPTION

FIG. 1 is a front three-quarter perspective view of the simulated electronic computer components embodying my design, comprising from top to bottom a simulated keyboard, a simulated CRT, a simulated diskette drive, and a simulated printer.

FIGS. 2-6 are, respectively, top, side elevation, front elevation, bottom, and rear elevation views on an enlarged scale of the keyboard portion of the simulated computer system design;

FIGS. 7-11 are, respectively, top, front elevation, side elevation, bottom, and rear elevation views of the CRT portion of the simulated computer system design;

FIGS. 12-16 are, respectively, top, front elevation, side elevation, rear elevation, and bottom views on an enlarged scale of the diskette drive portion of the simulated computer system design;

FIGS. 17-21 are, respectively, rear elevation, bottom, top, front elevation, and right side elevation views of the printer portion of the simulated computer system design.

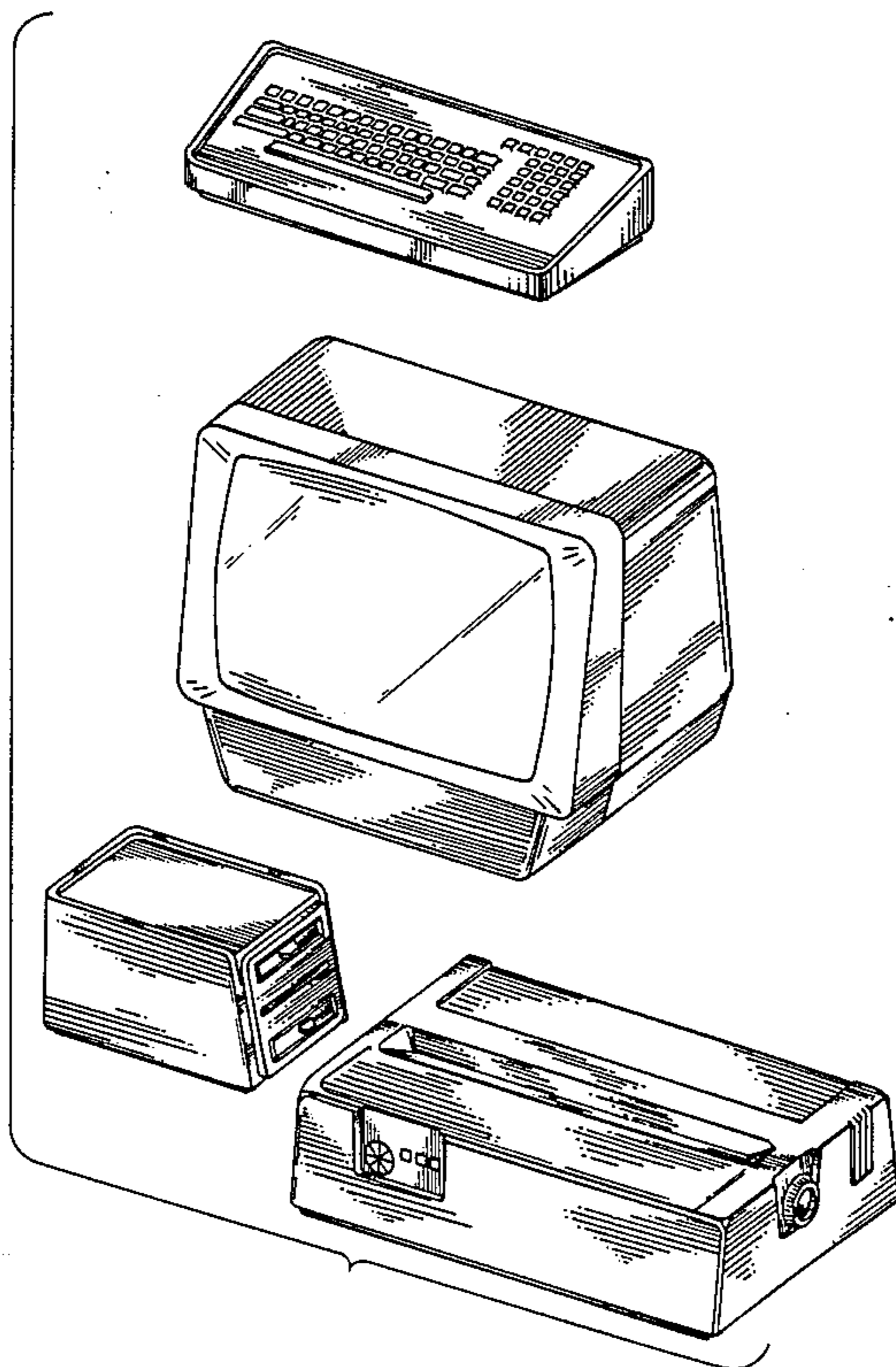

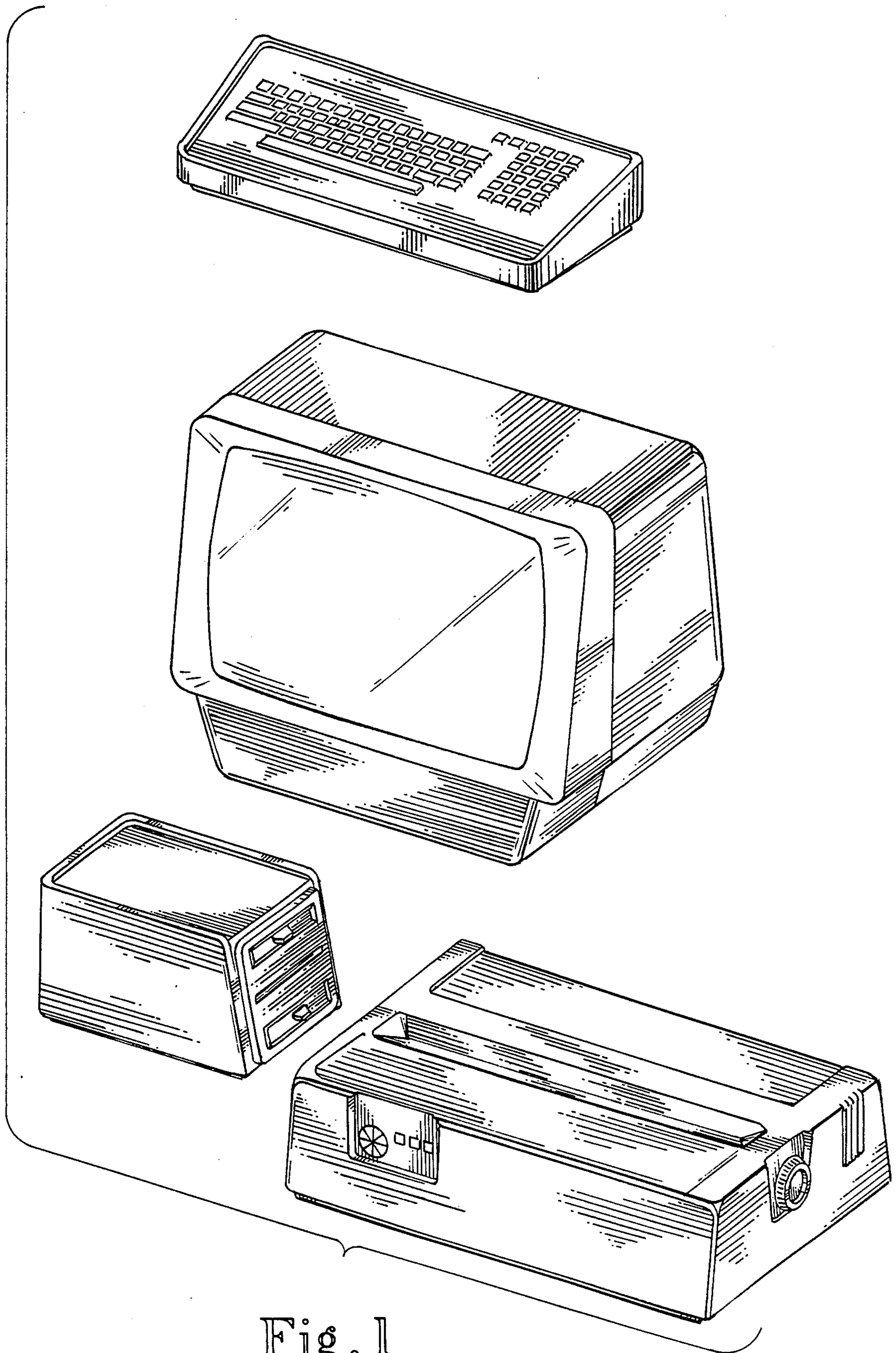

Fig. 1

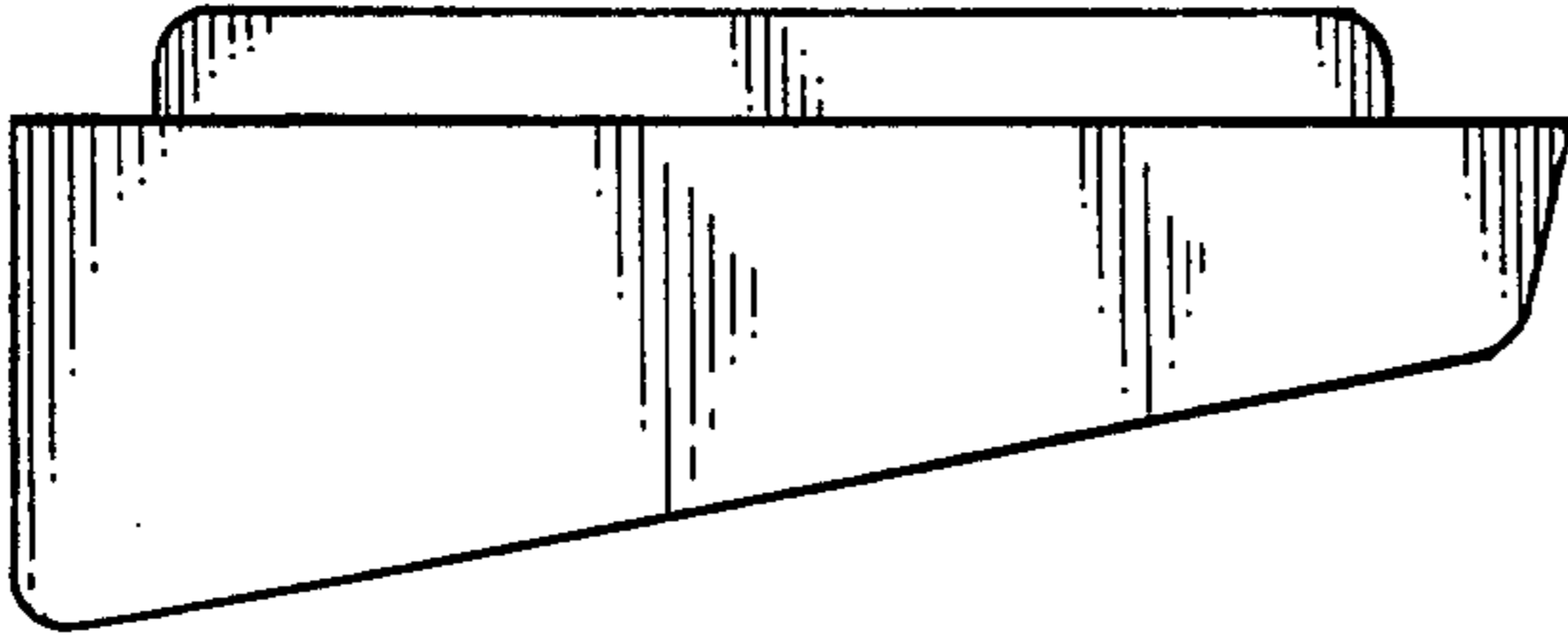

Fig. 3

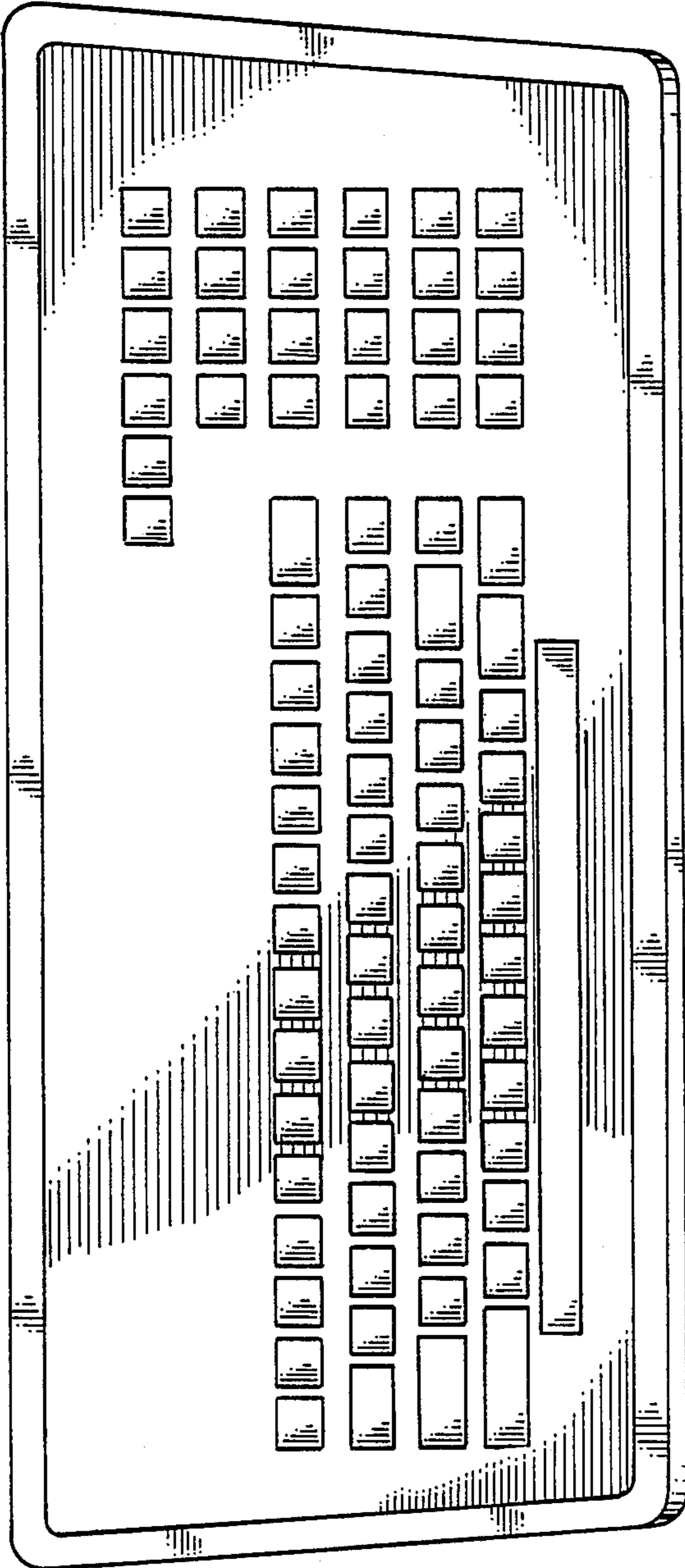

Fig. 2

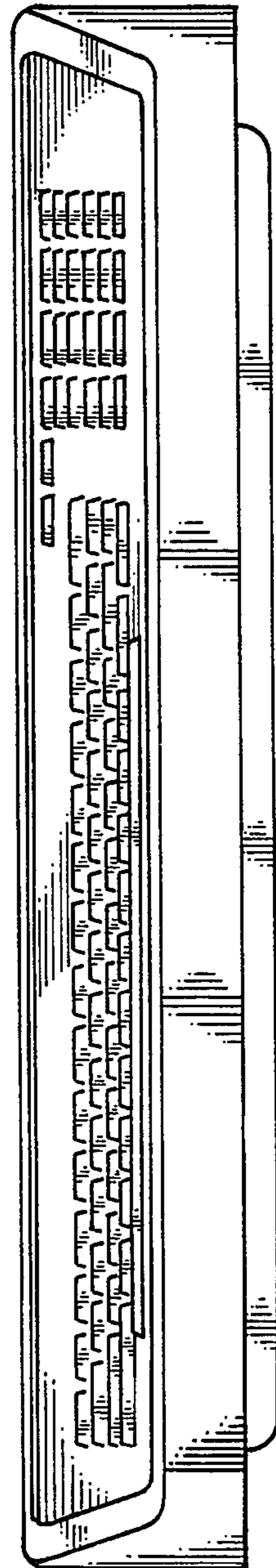

Fig. 4

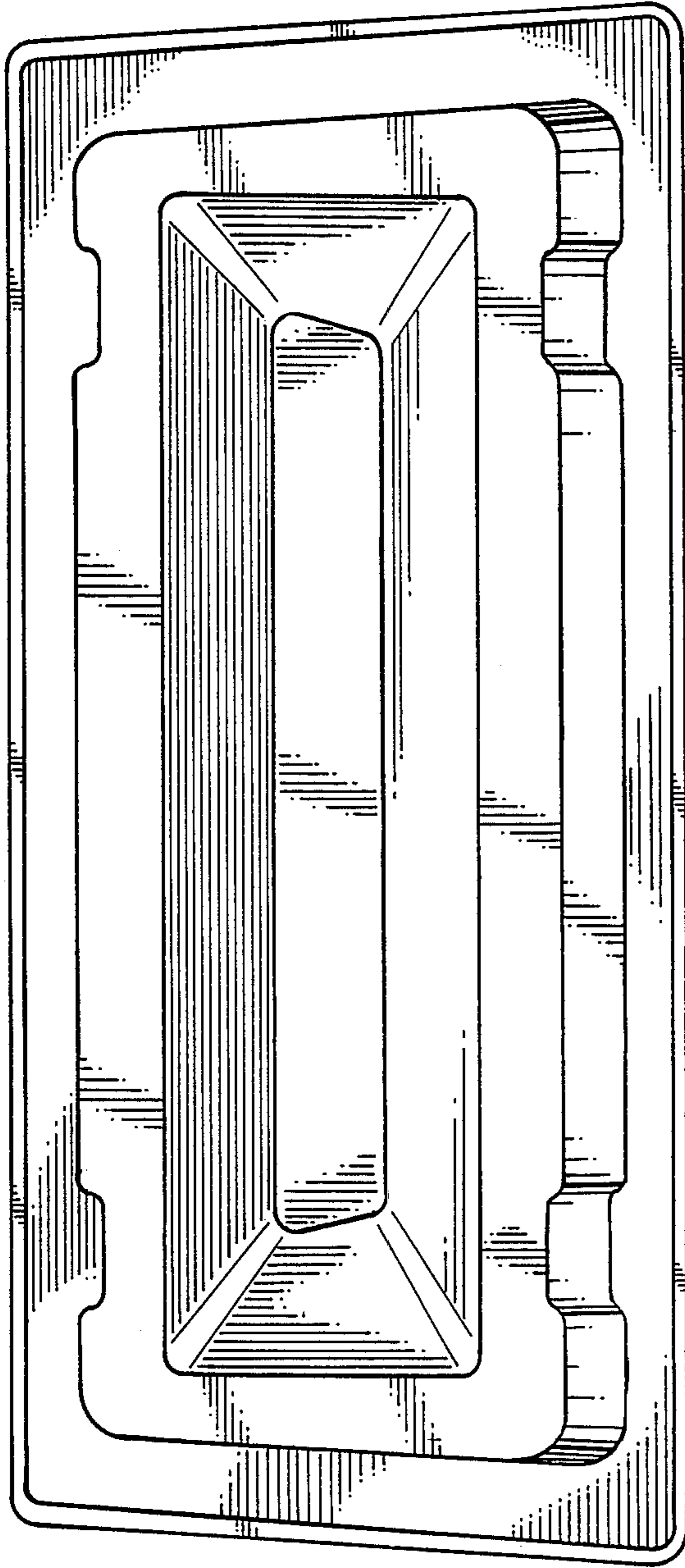

Fig. 5

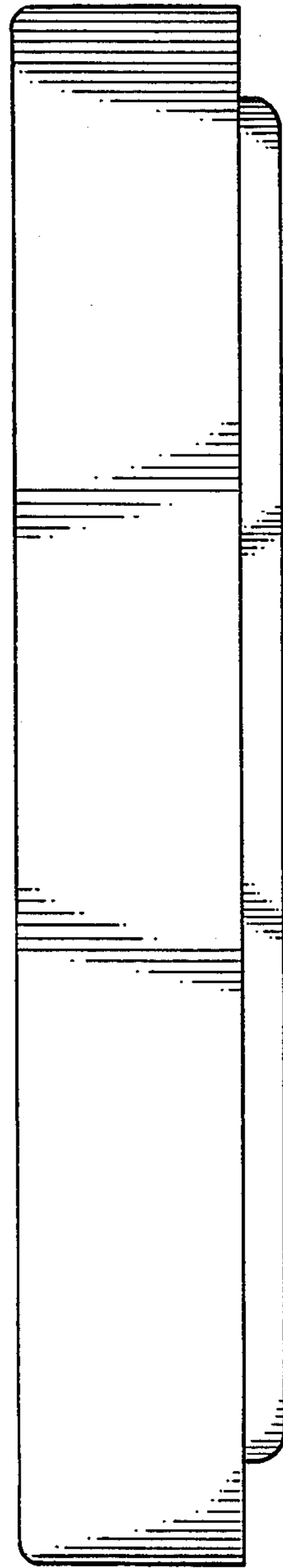

Fig. 6

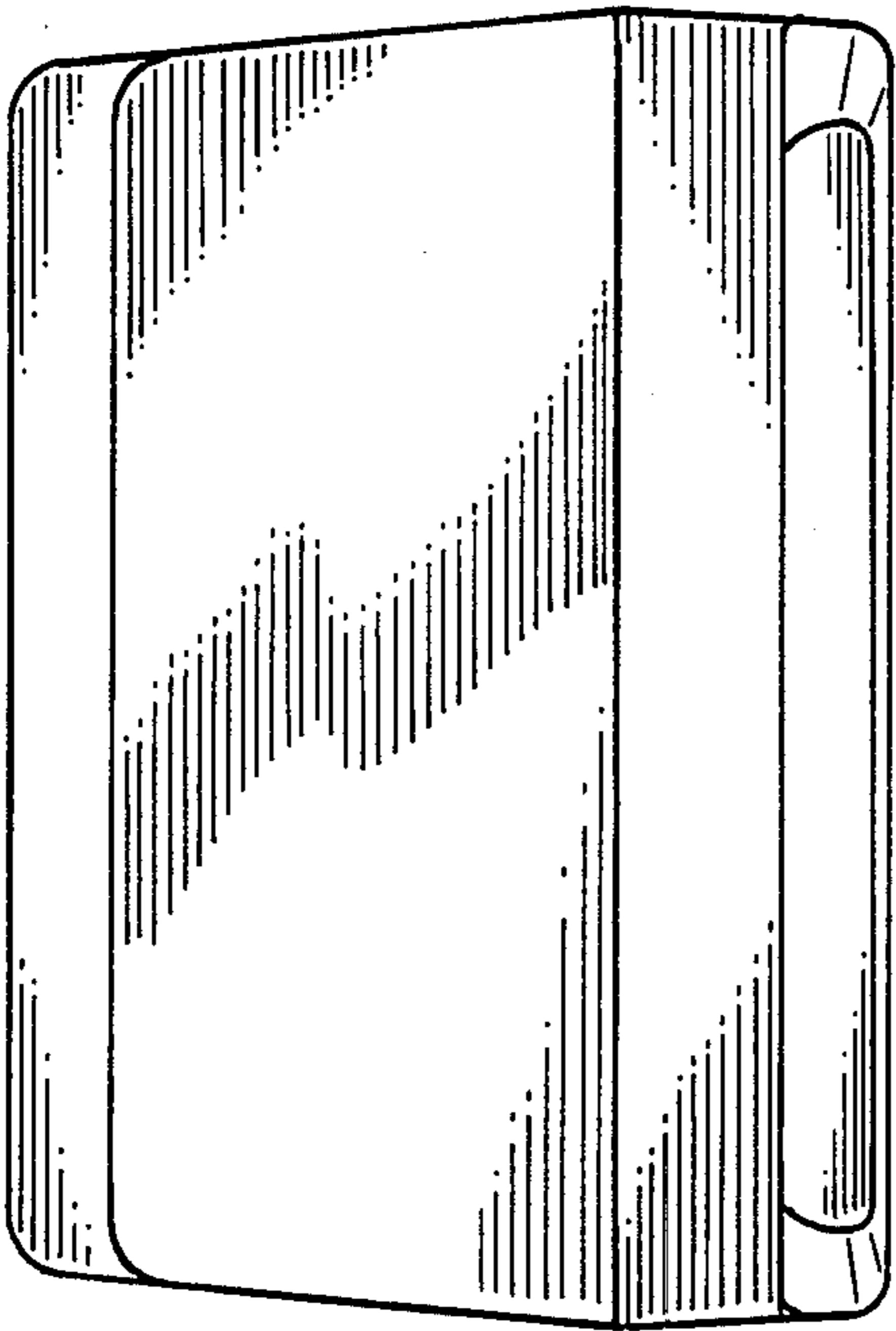

Fig. 7

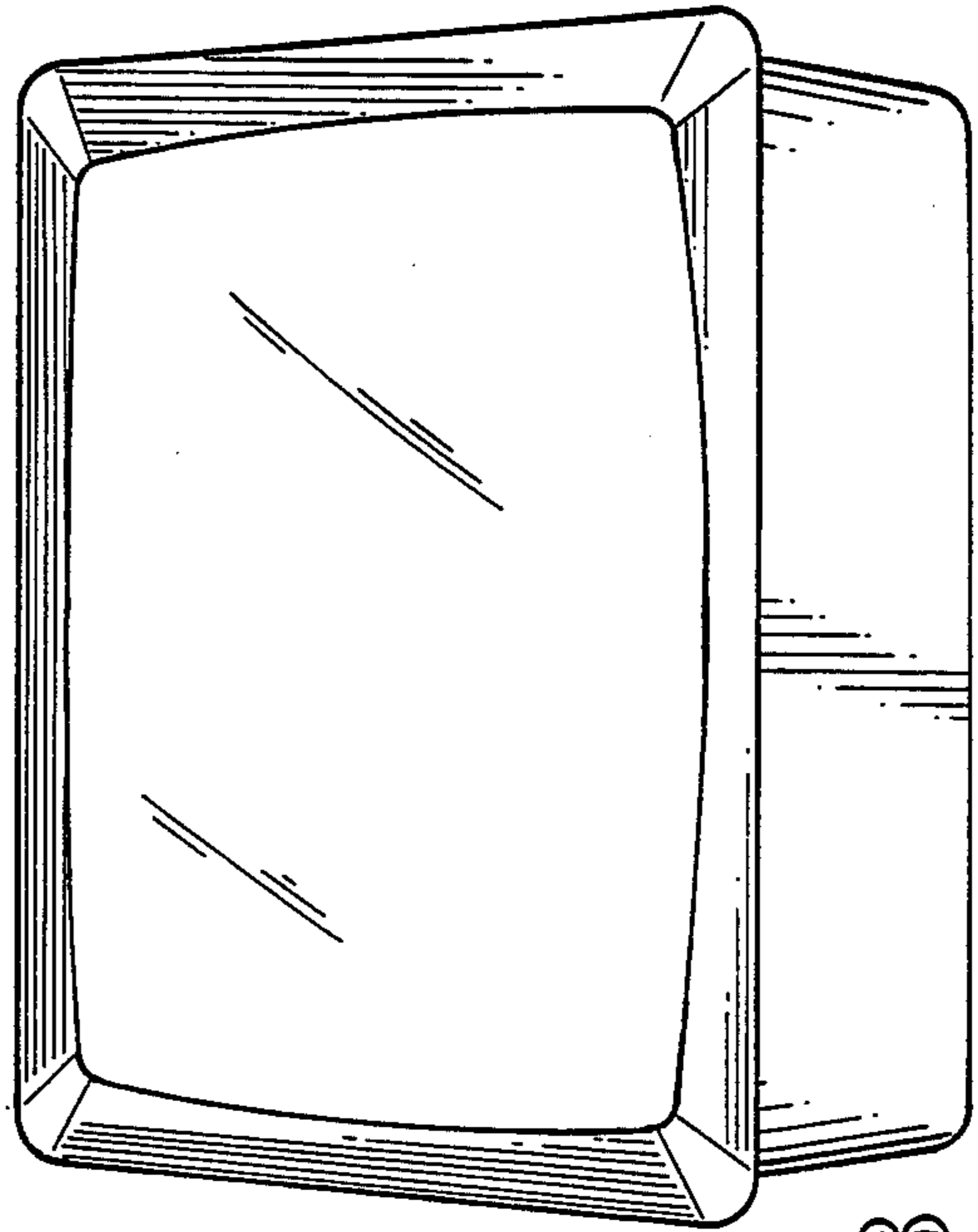

Fig. 8

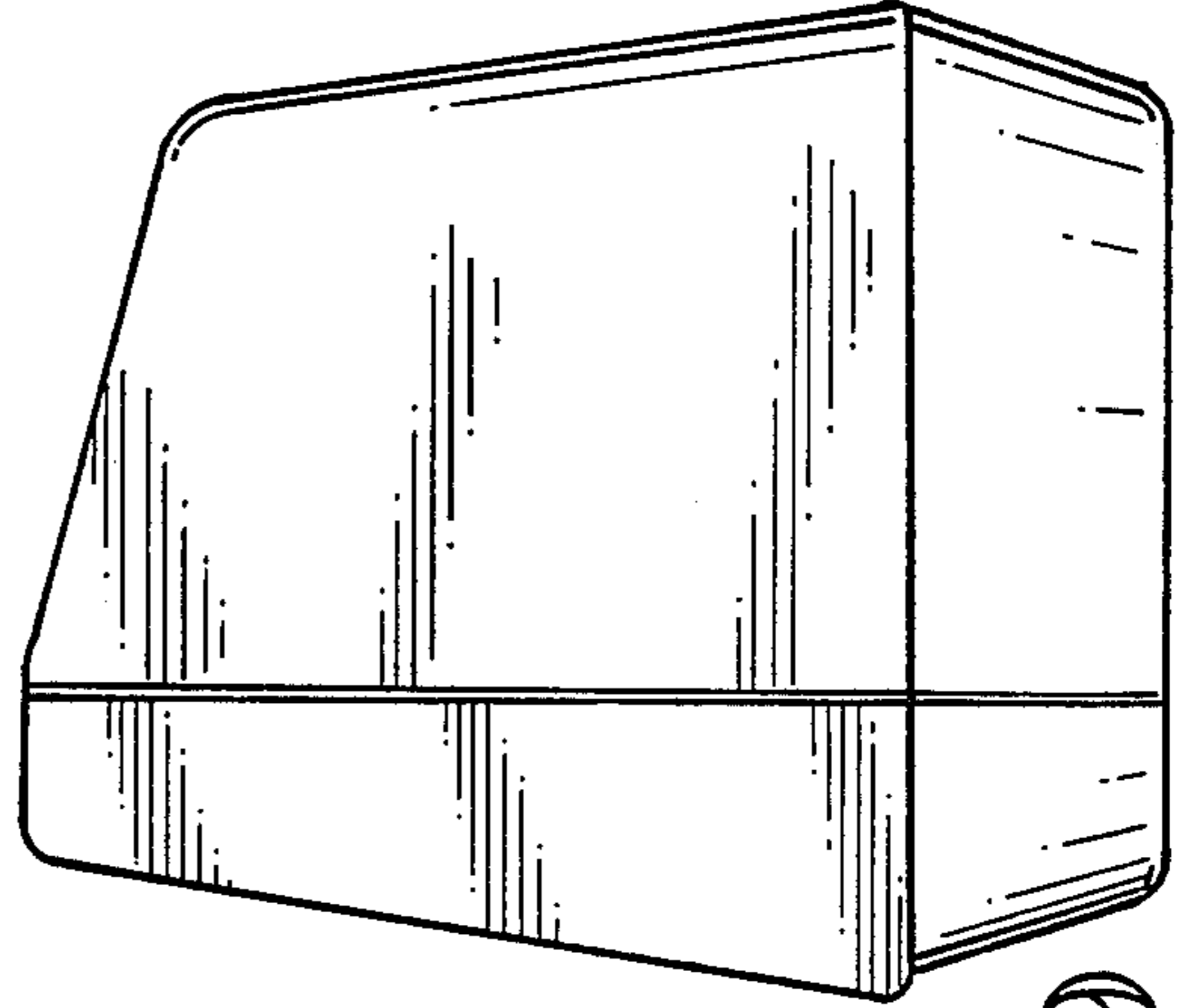

Fig. 9

Fig. 10

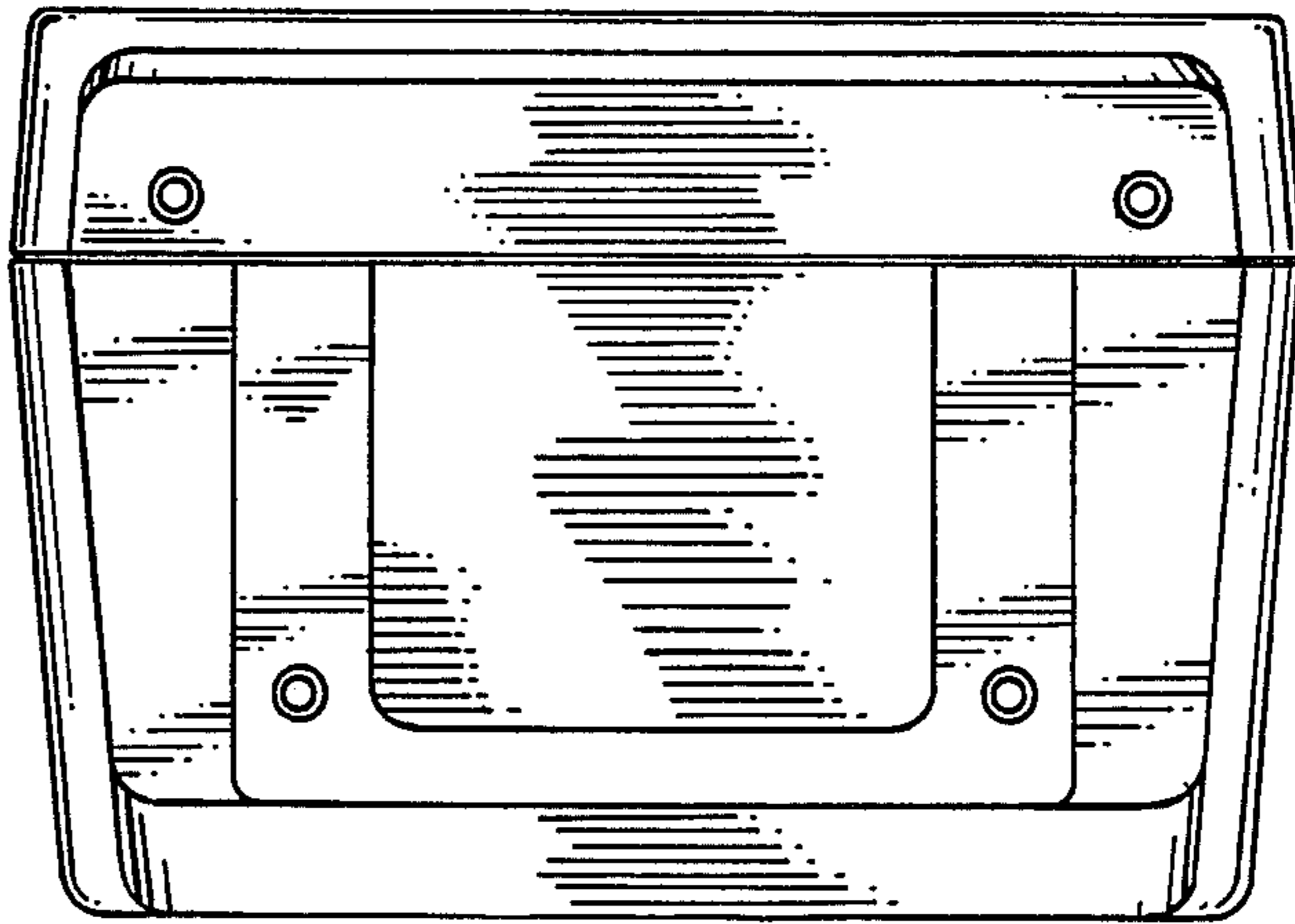
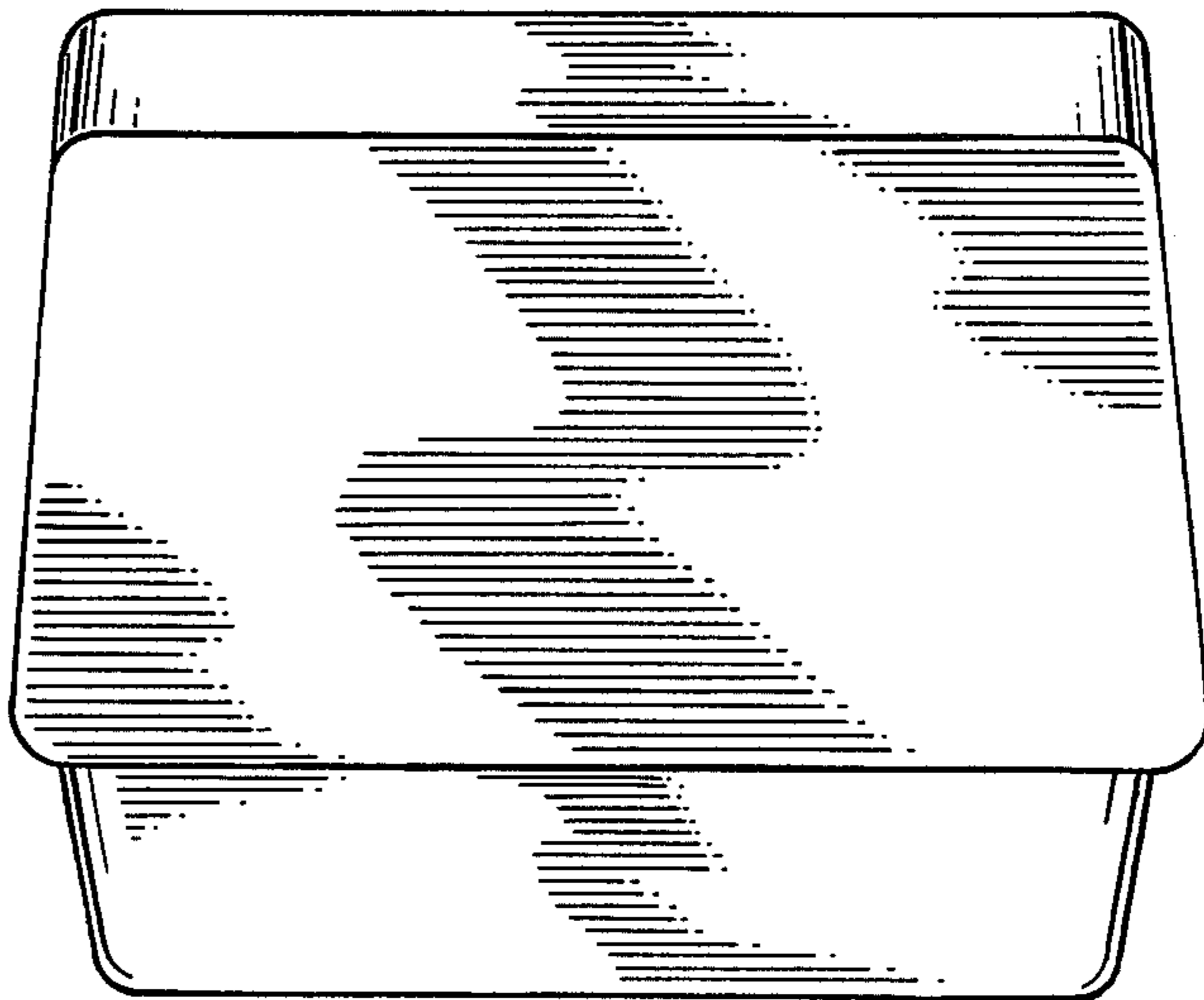

Fig. 11



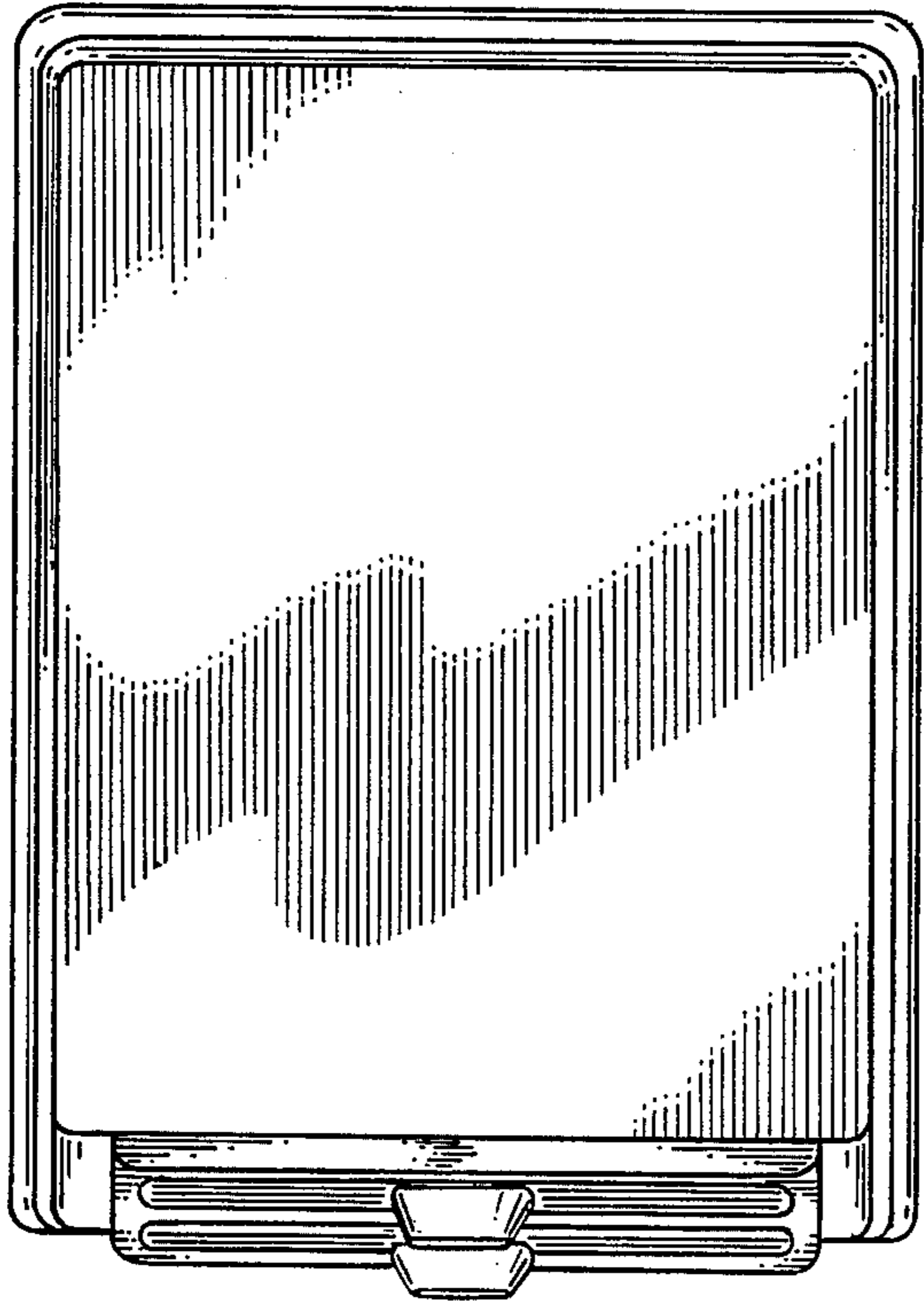

Fig. 12

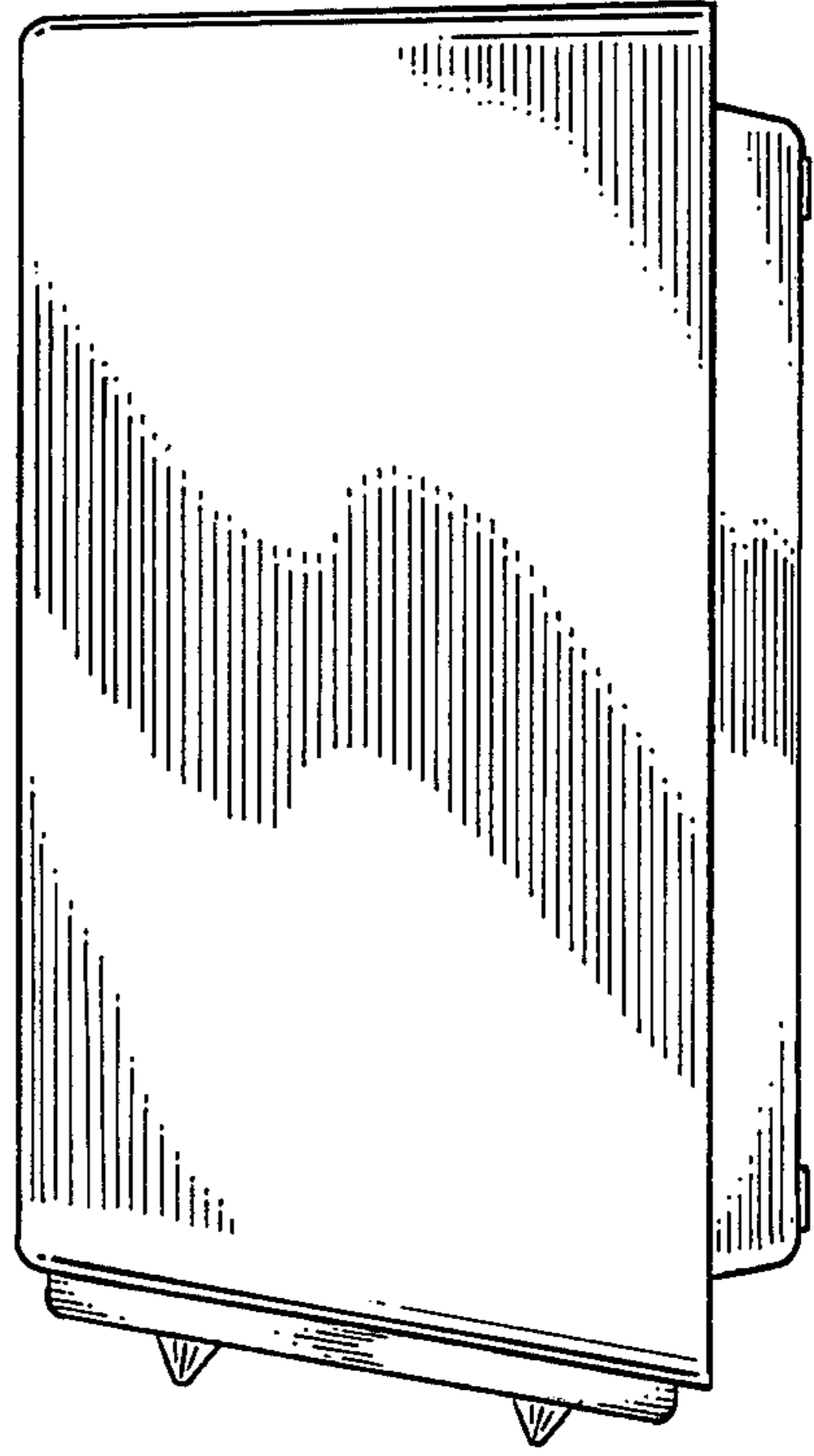

Fig. 14

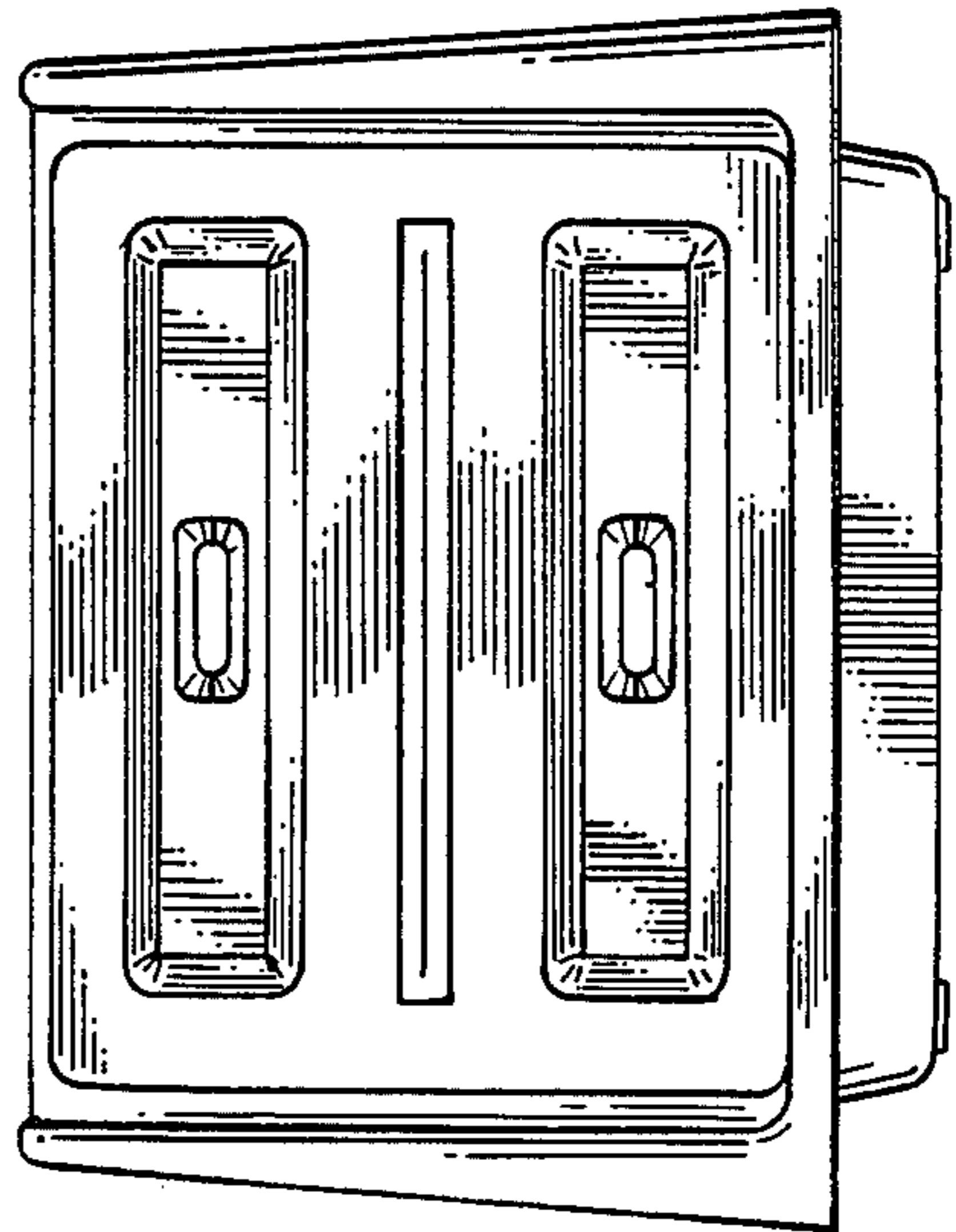

Fig. 13

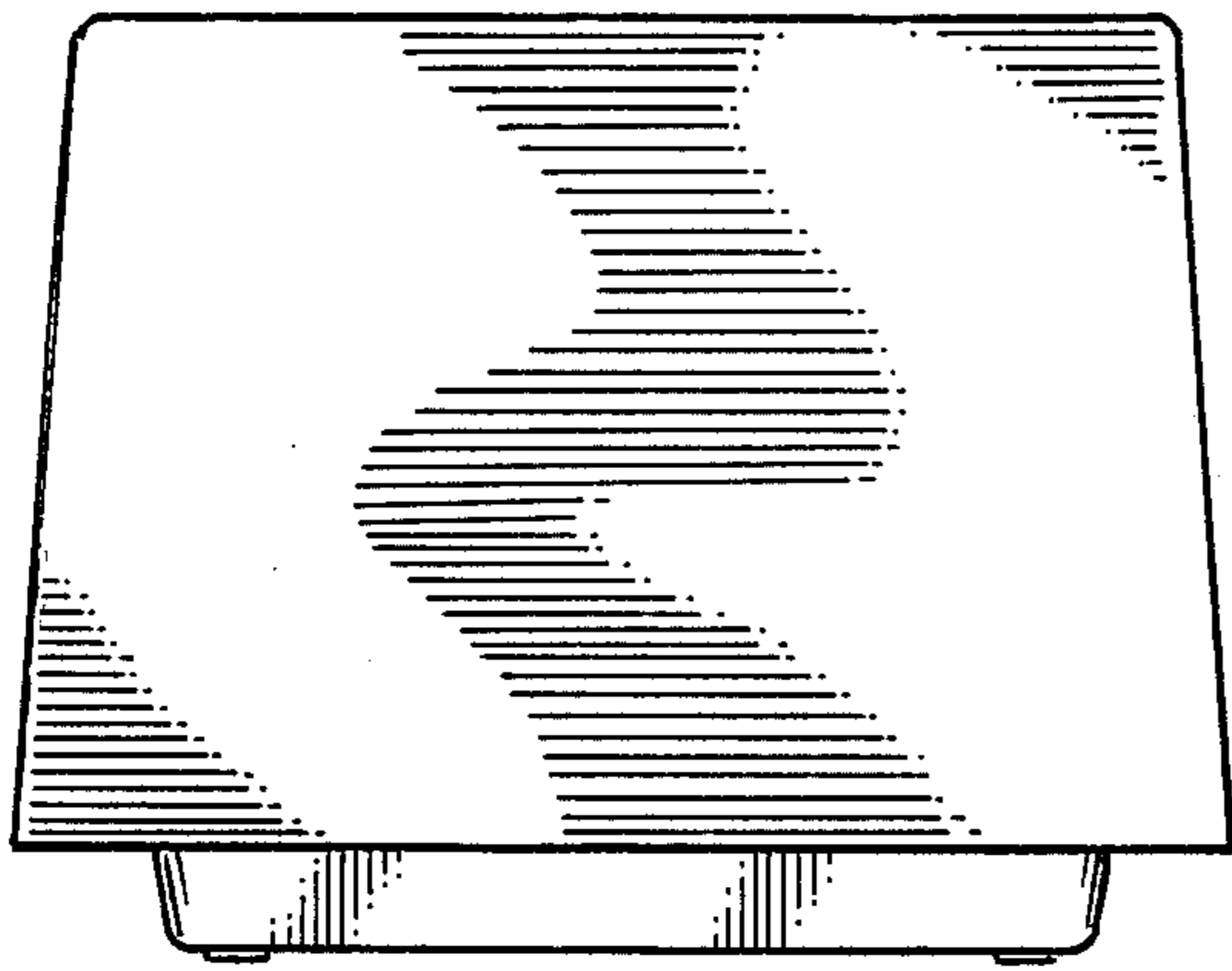

Fig. 15

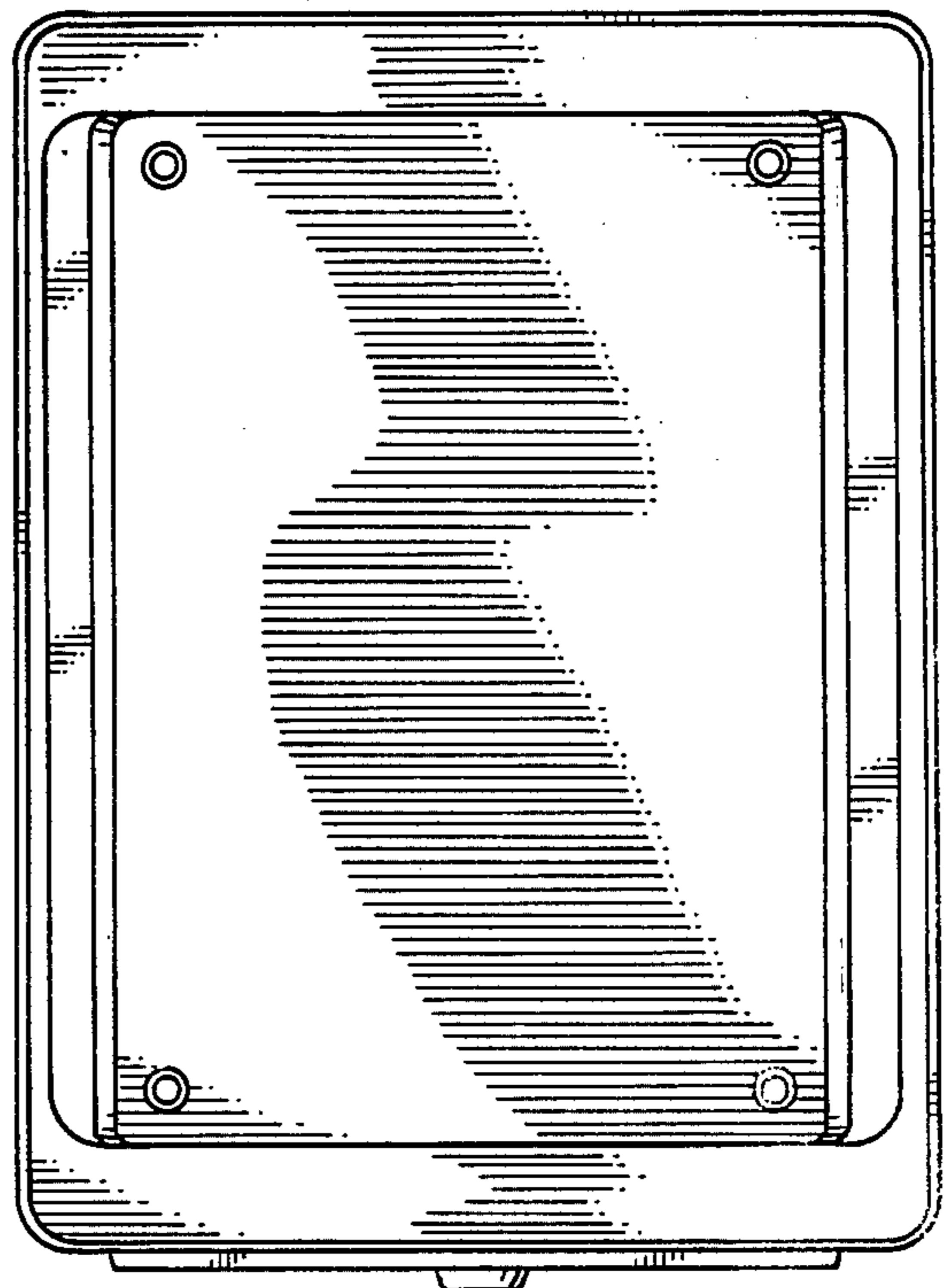

Fig. 16

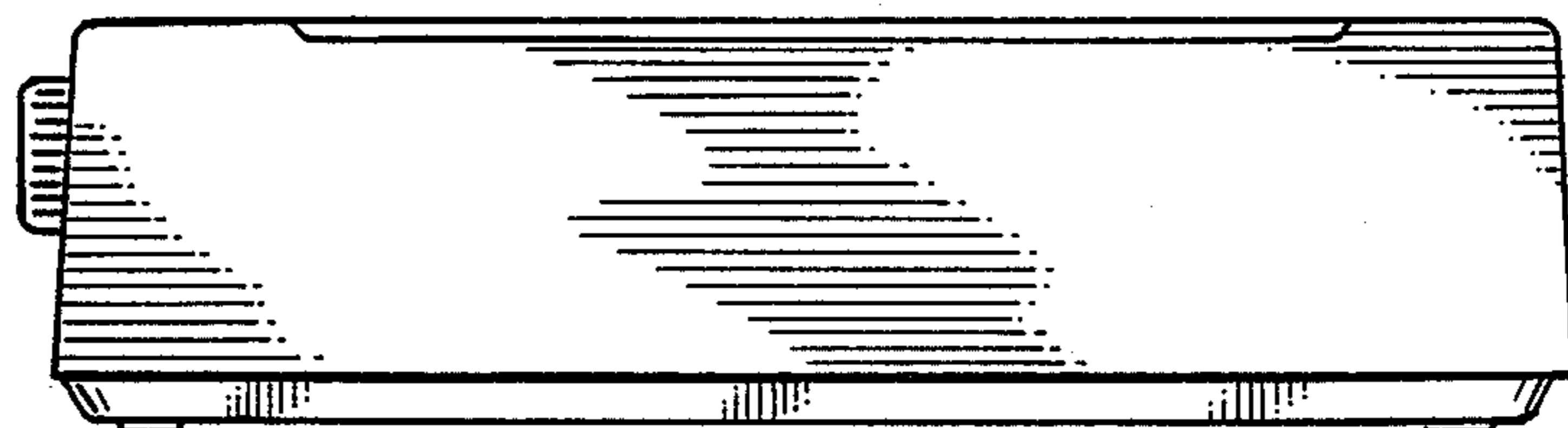

Fig. 17

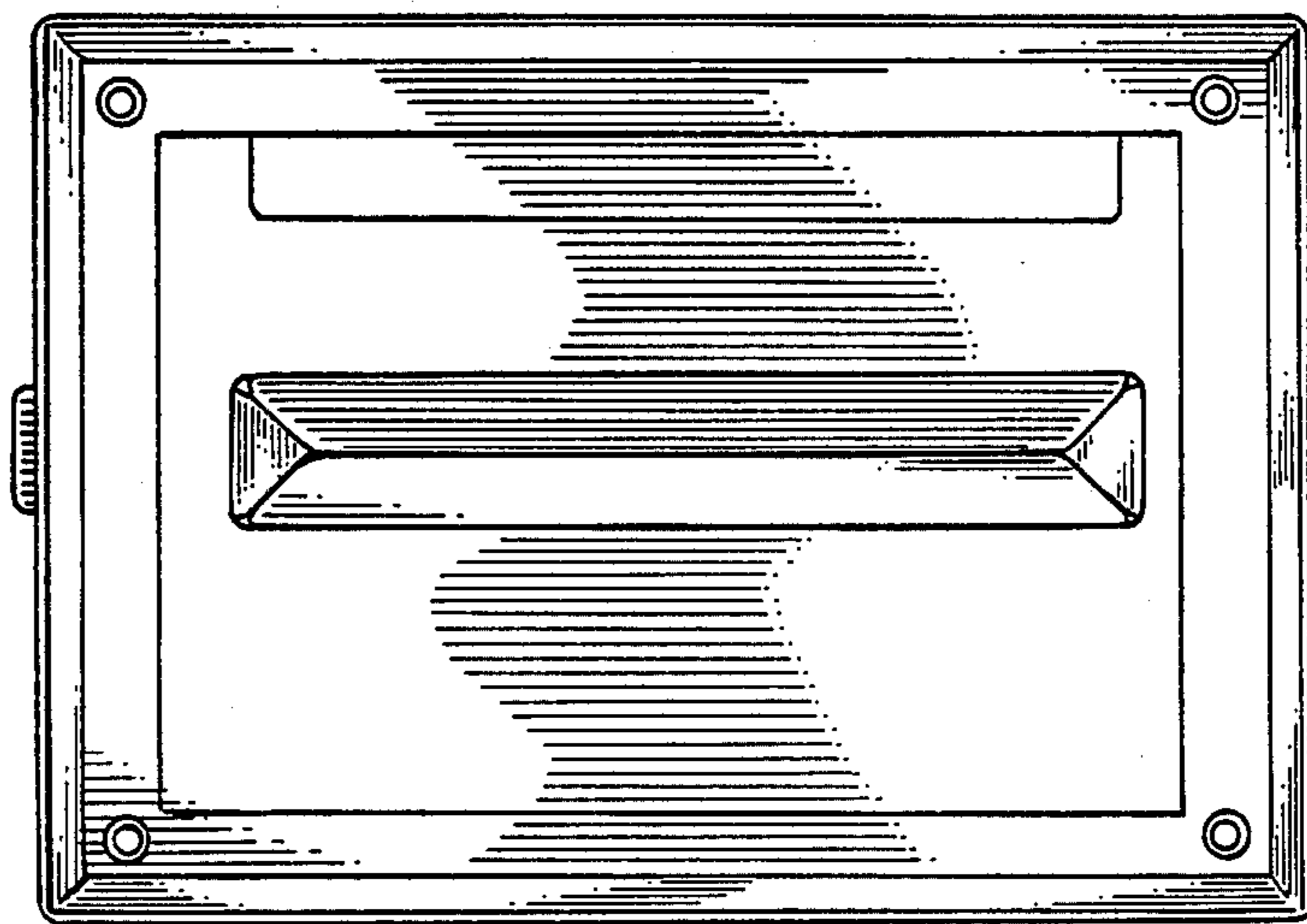

Fig. 18

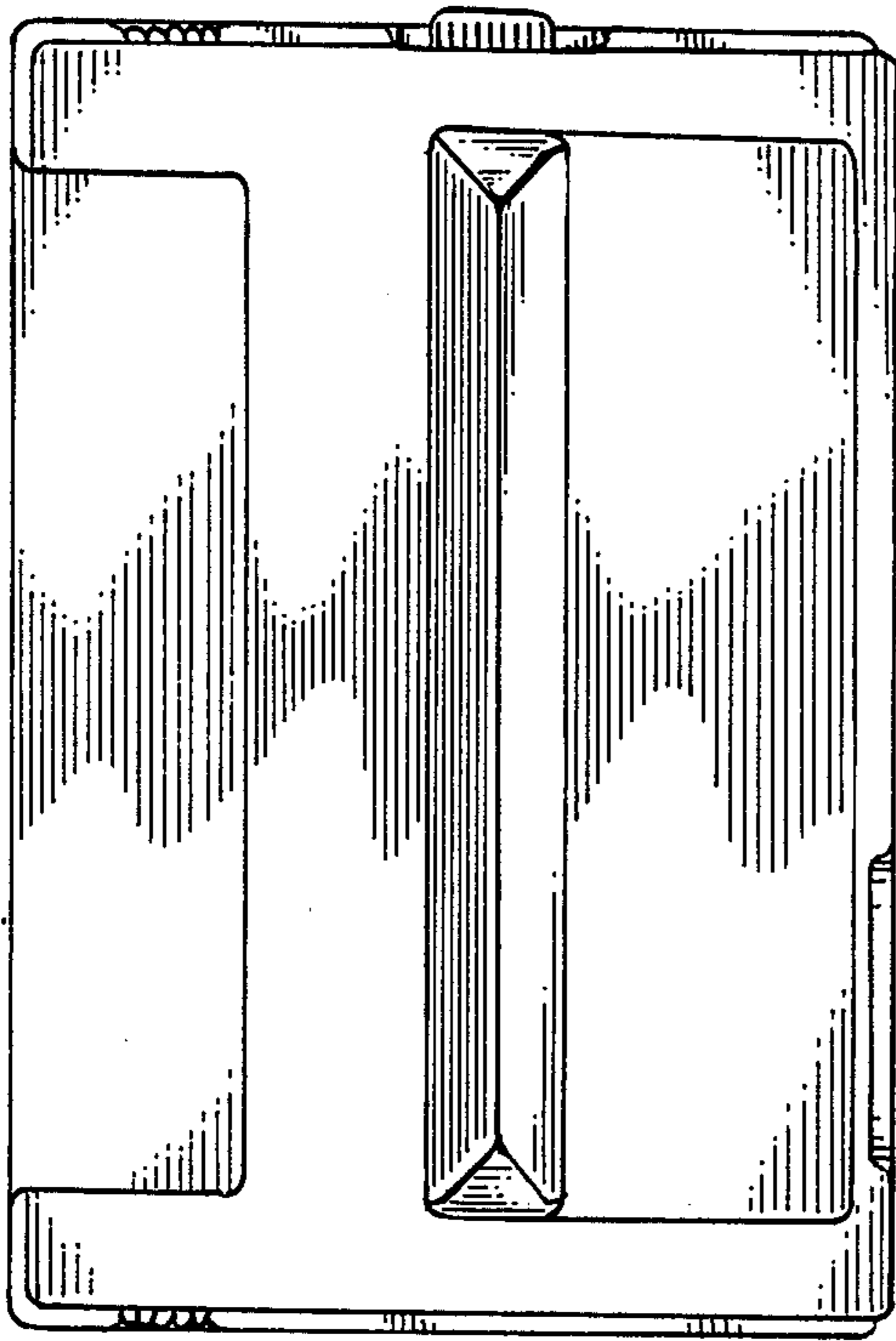

Fig. 19

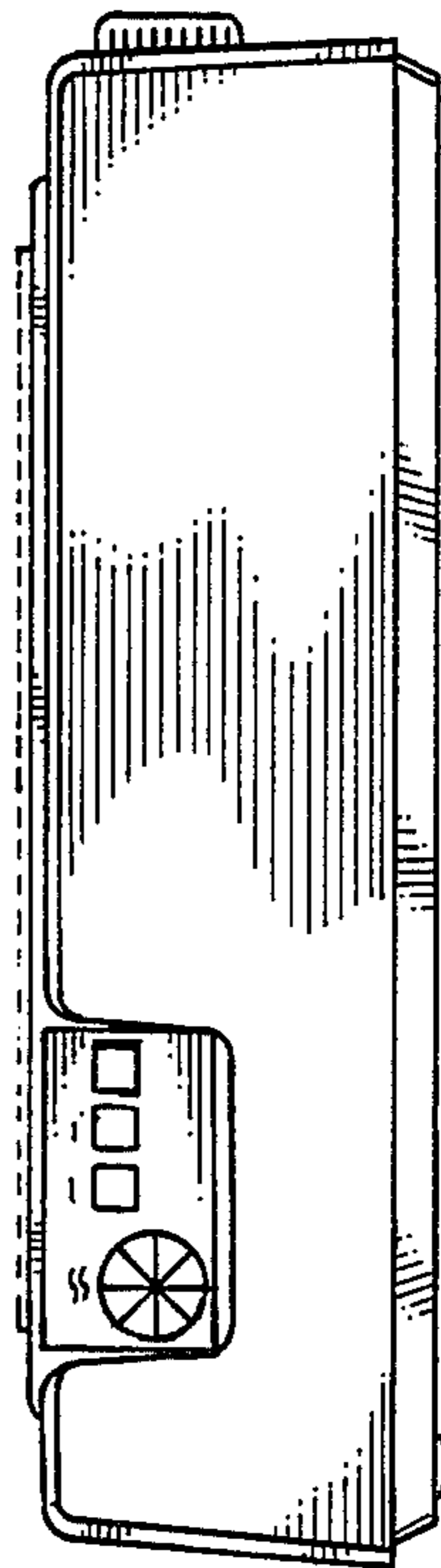

Fig. 20

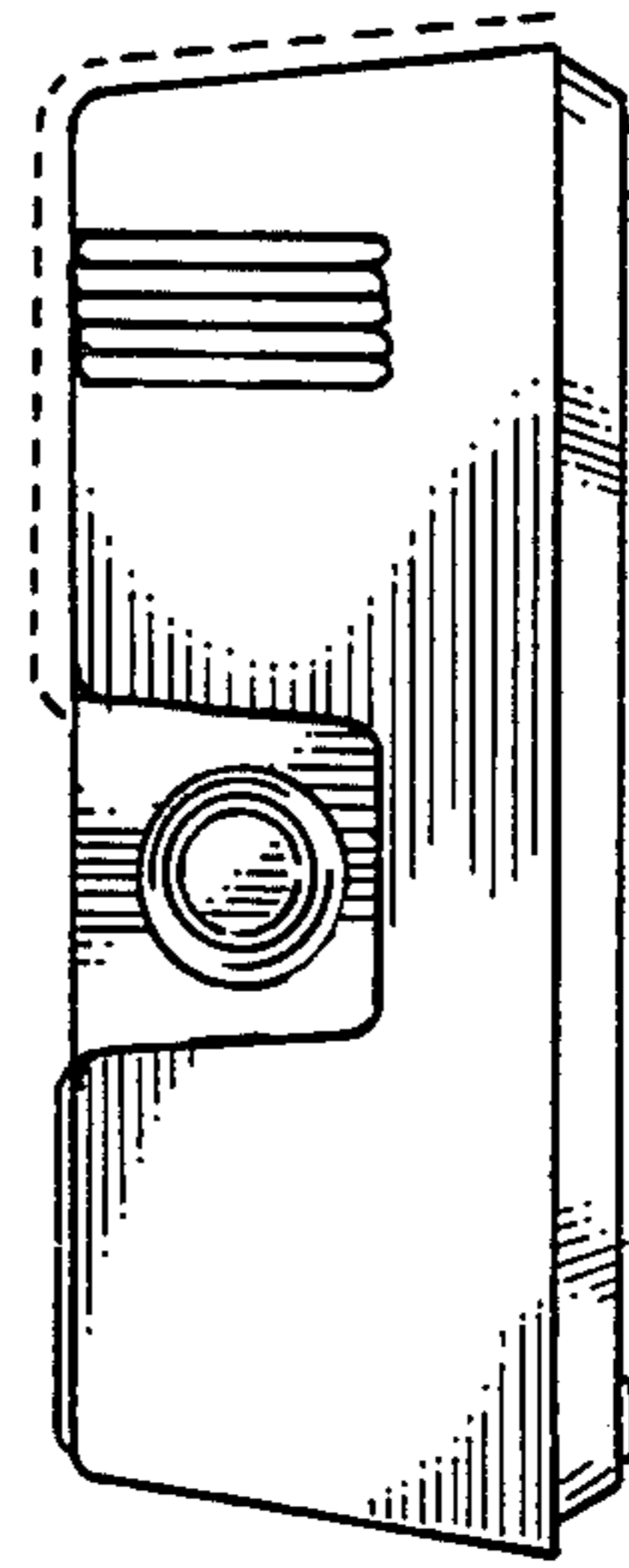

Fig. 21