

[54] STORAGE CASE FOR DISKETTES OR THE LIKE

[75] Inventors: Craig D. Drake; Ross A. Jessen, both of Muscatine, Iowa

[73] Assignee: Ring King Visibles, Inc., Muscatine, Iowa

[**] Term: 14 Years

[21] Appl. No.: 742,630

[22] Filed: Jun. 7, 1985

[52] U.S. Cl. D3/35

[58] Field of Search D3/35, 78; D19/76; 206/387, 444, 472, 425; 40/371; 312/294

[56] References Cited

U.S. PATENT DOCUMENTS

- D. 287,068 12/1986 Long et al. D3/78
- D. 287,788 1/1987 Shames et al. D3/78

OTHER PUBLICATIONS

Office Products Dealer, 2-1982, p. 182, "Desk-Top Tray" at top left corner of page.

Primary Examiner—Charles A. Rademaker
Attorney, Agent, or Firm—Neuman, Williams, Anderson & Olson

[57] CLAIM

The ornamental design for a storage case for diskettes or the like, as shown and described.

DESCRIPTION

FIG. 1 is a front perspective view of a storage case for diskettes or the like showing our new design, with the case closed;

FIG. 2 is a rear perspective view thereof;

FIG. 3 is a front perspective view thereof with the case fully opened;

FIG. 4 is a plan view thereof with the case closed;

FIG. 5 is a front elevational view thereof with the case closed;

FIG. 6 is a rear elevational view with the case closed;

FIG. 7 is a bottom view thereof with the case closed; and,

FIG. 8 is a side elevational view thereof with the case closed.

The broken line showing of environment in FIGS. 3 and 7 is for illustrative purposes only and forms no part of the claimed design.

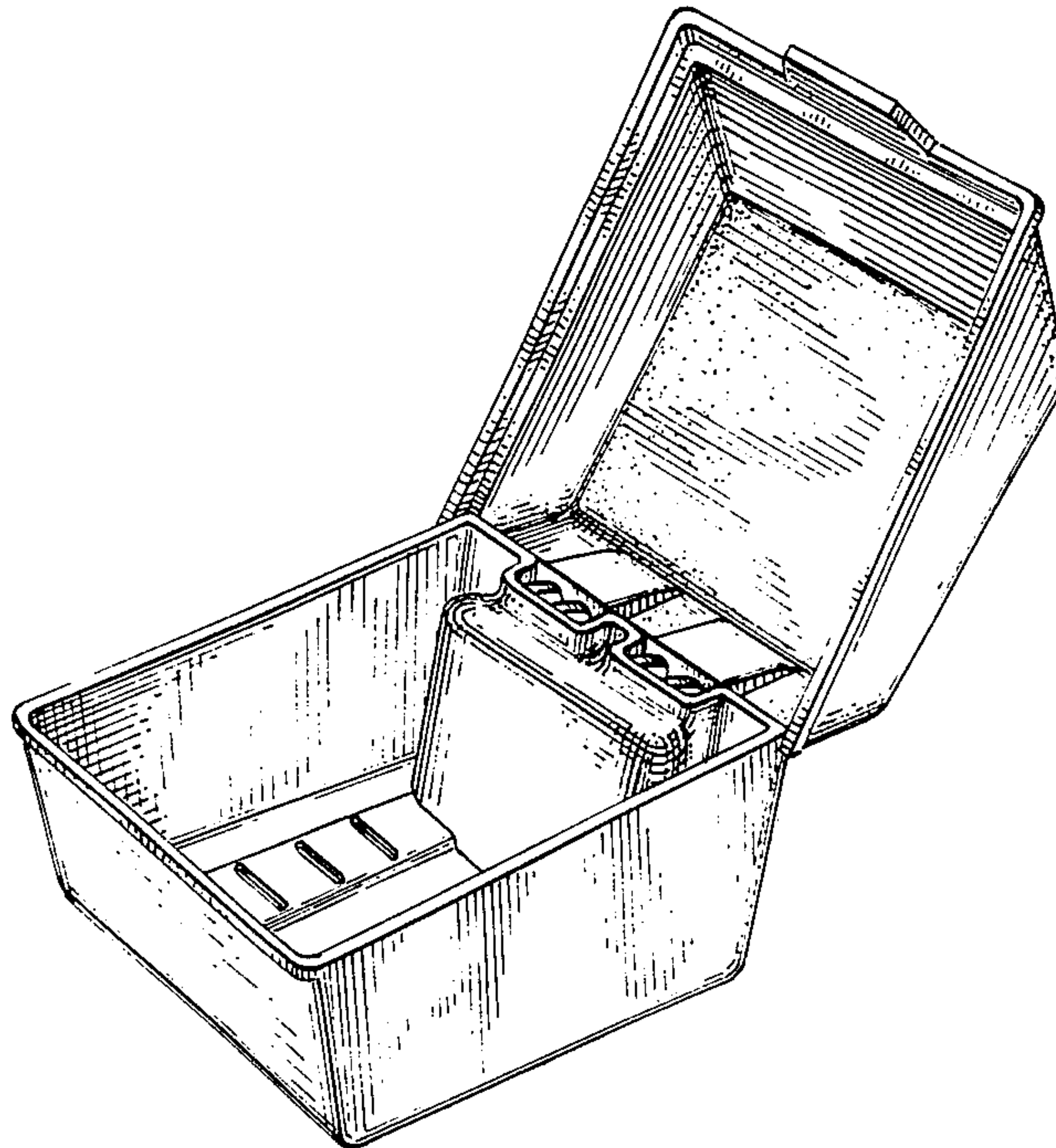

FIG. 1

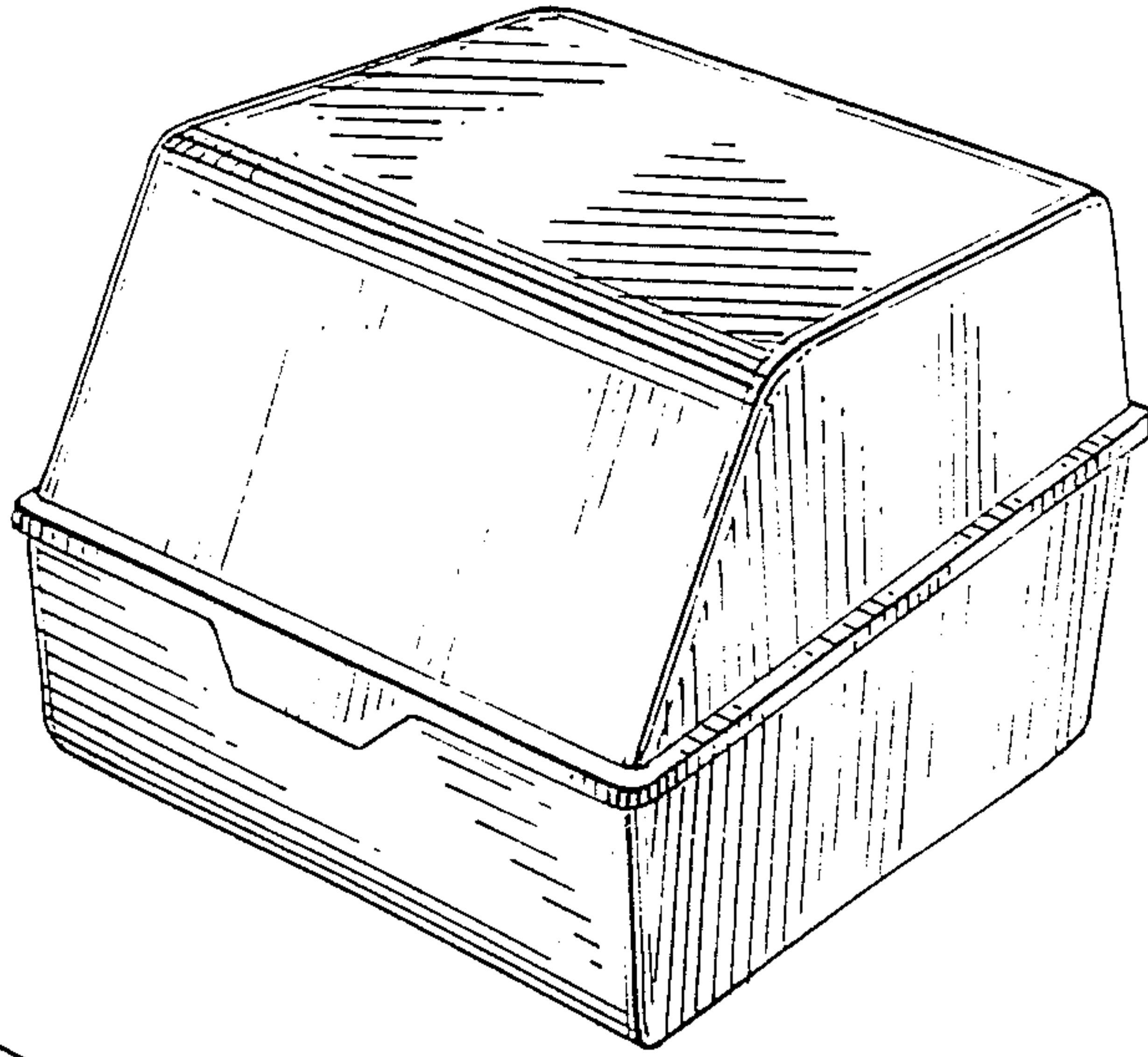

FIG. 2

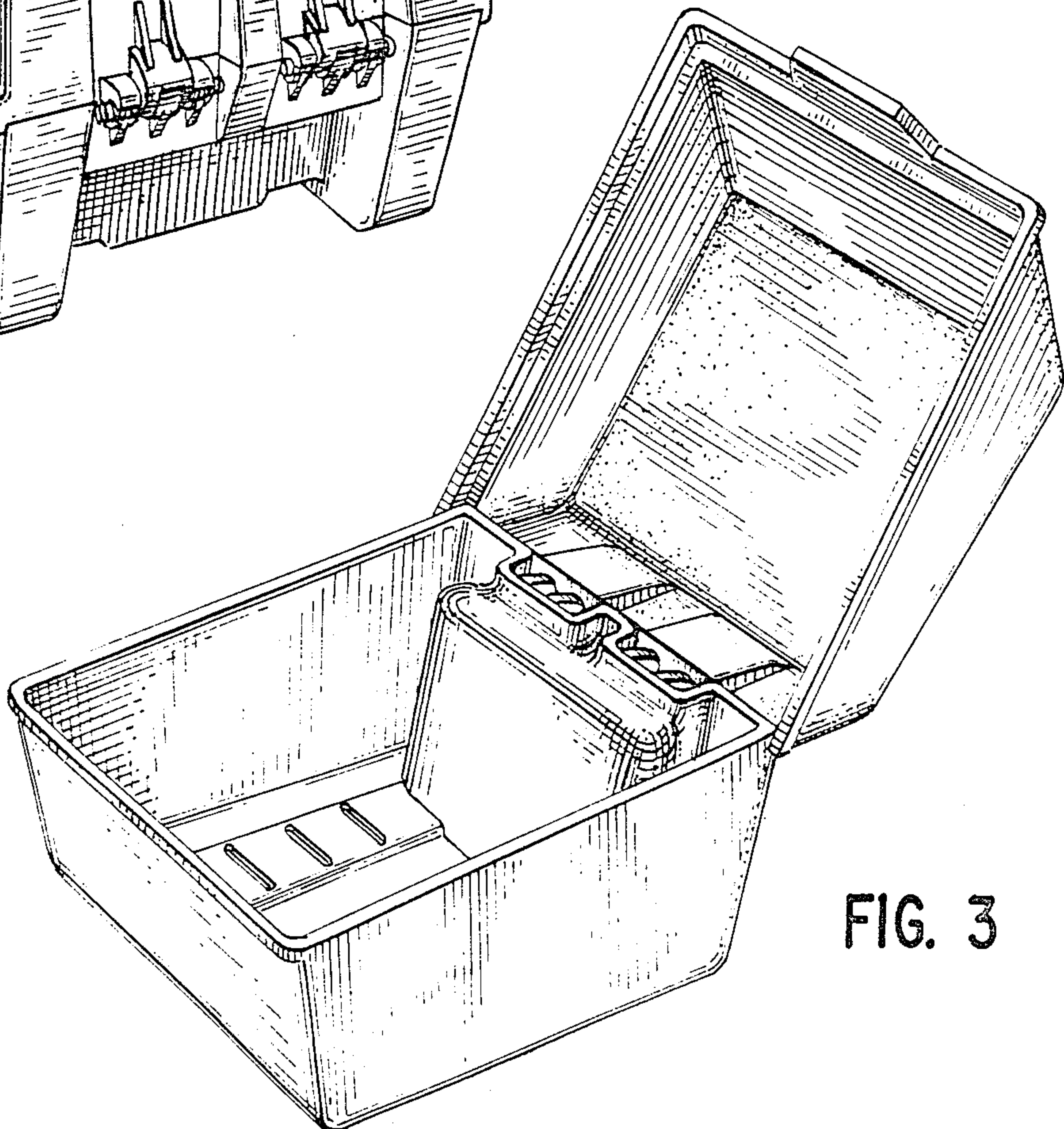
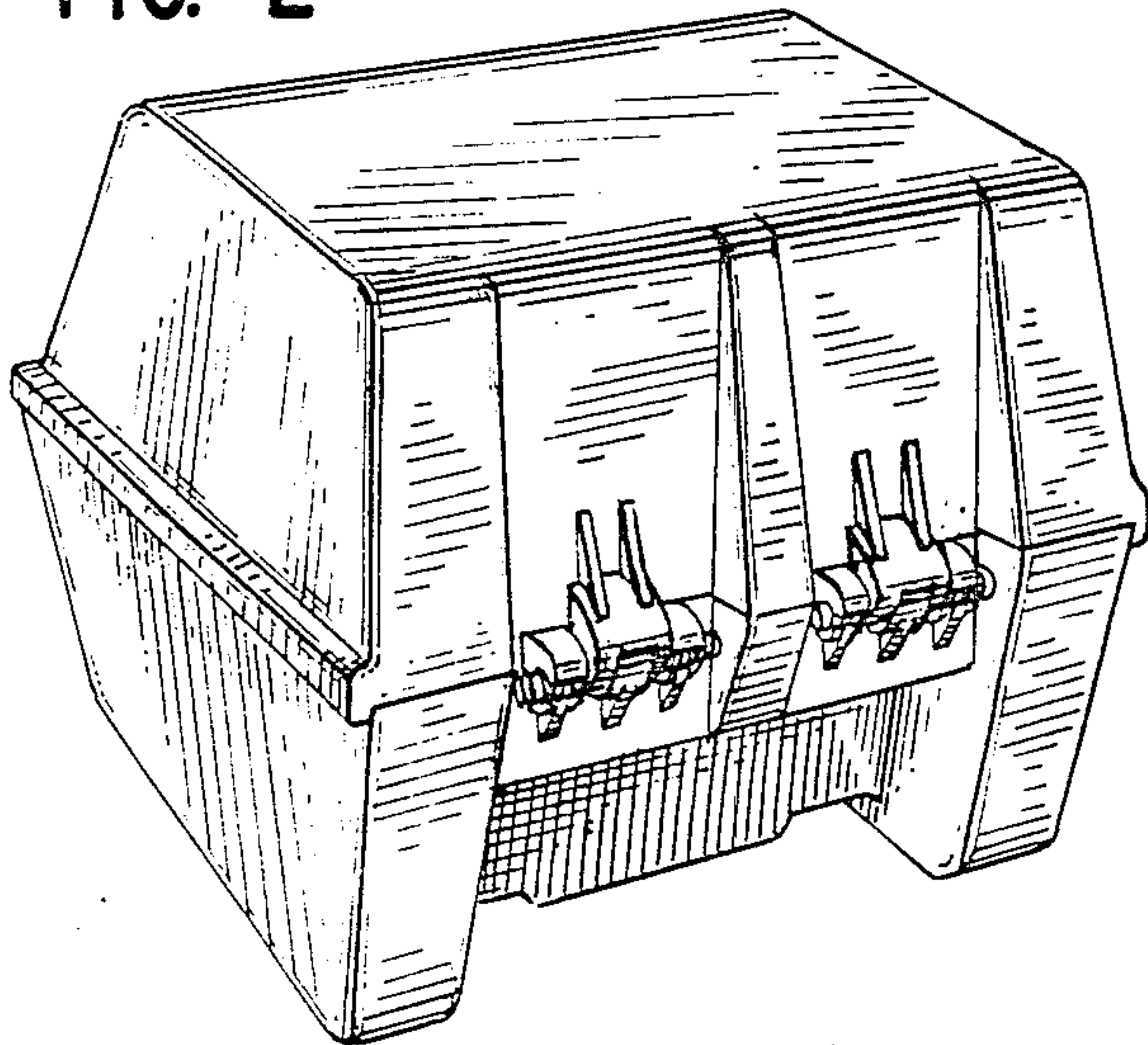

FIG. 3

FIG. 4

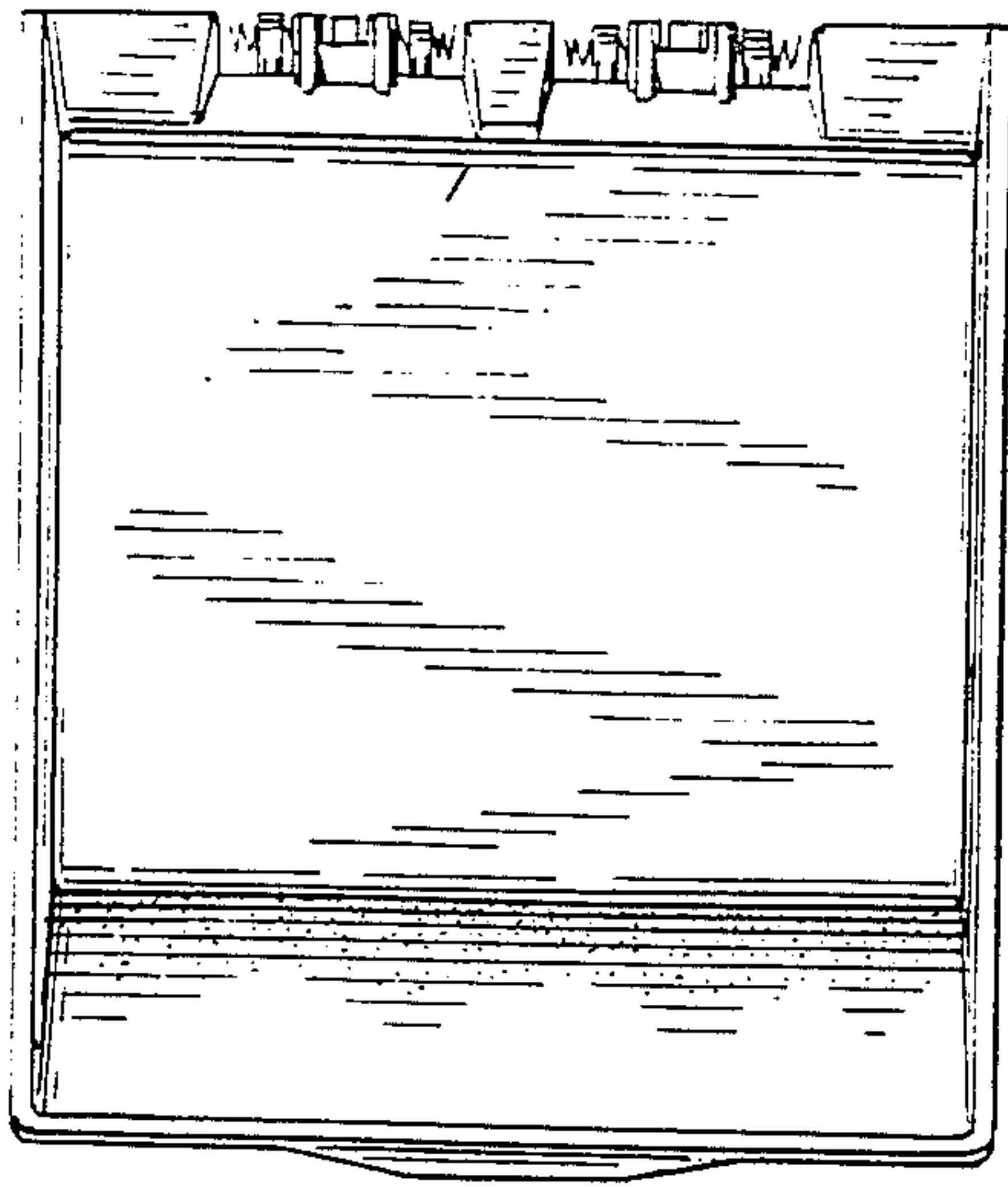

FIG. 6

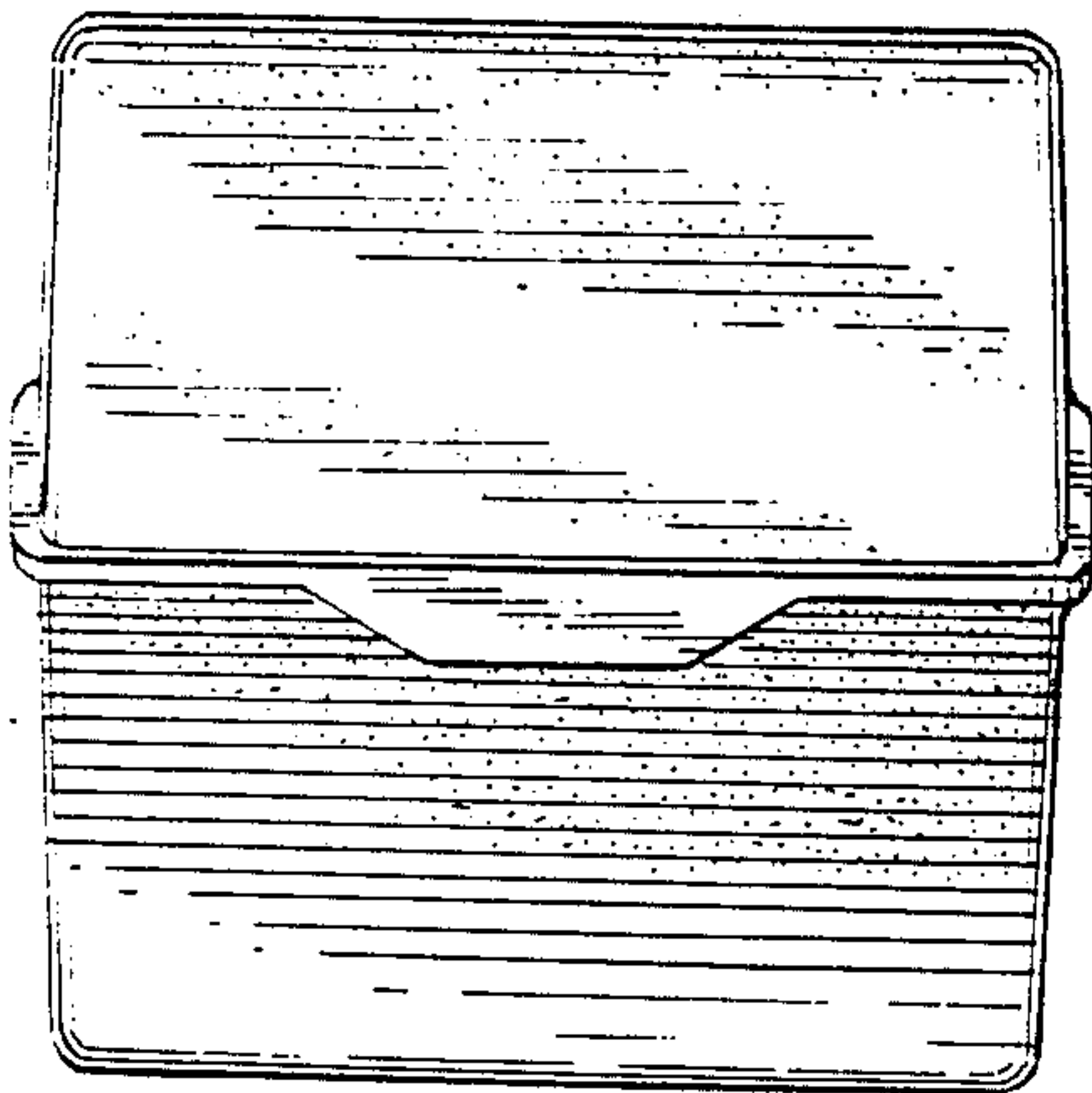
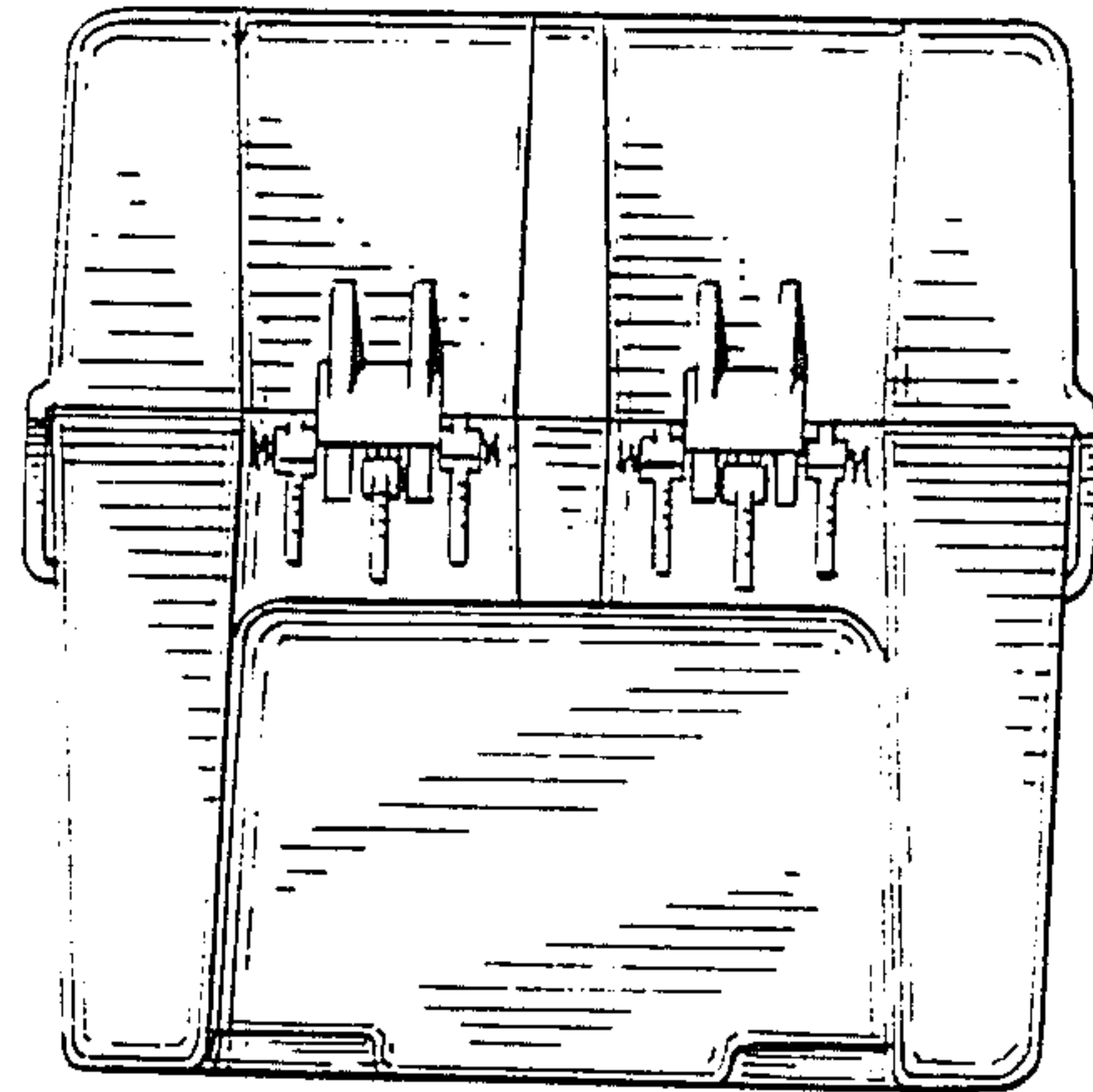

FIG. 5

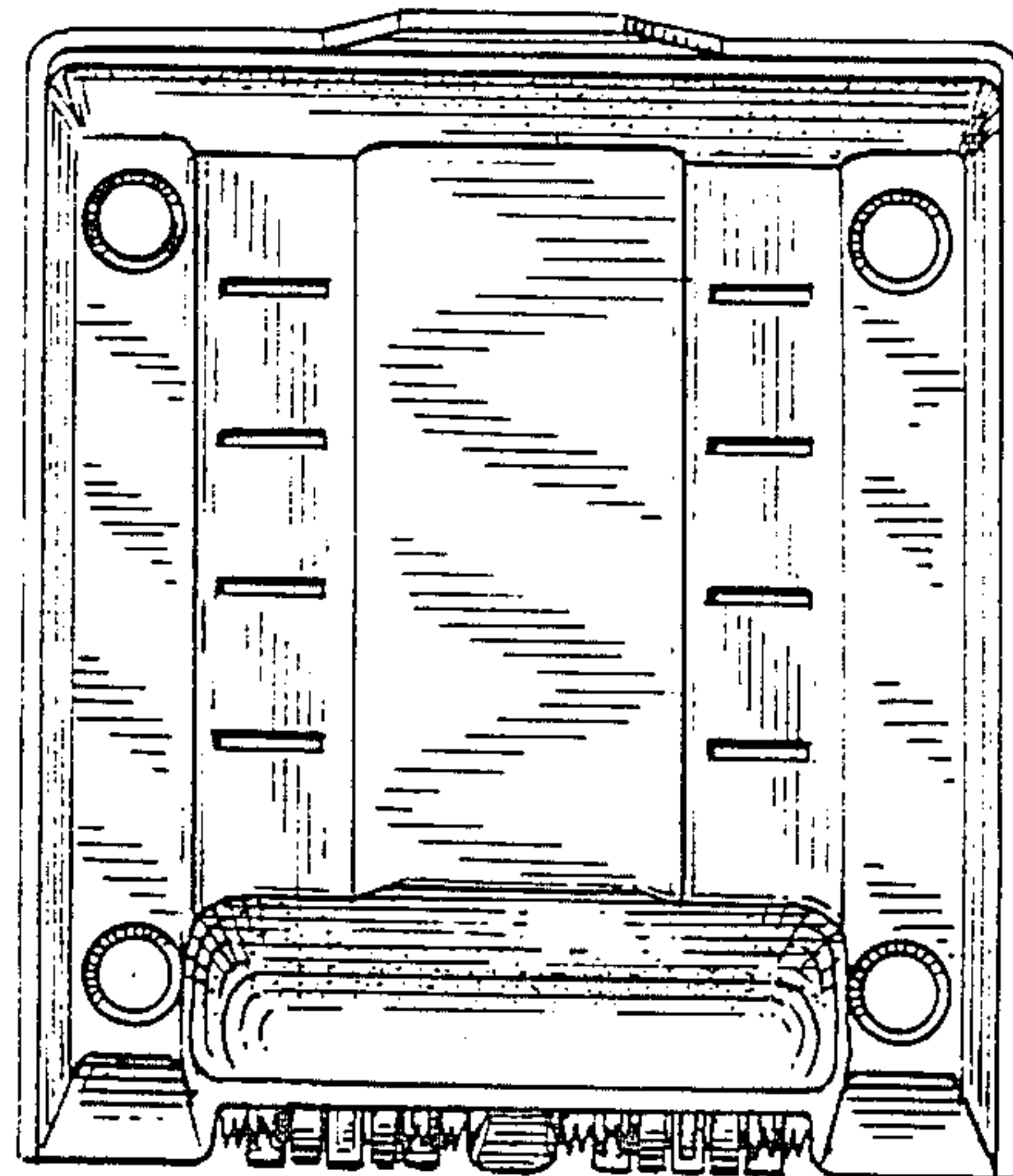

FIG. 7

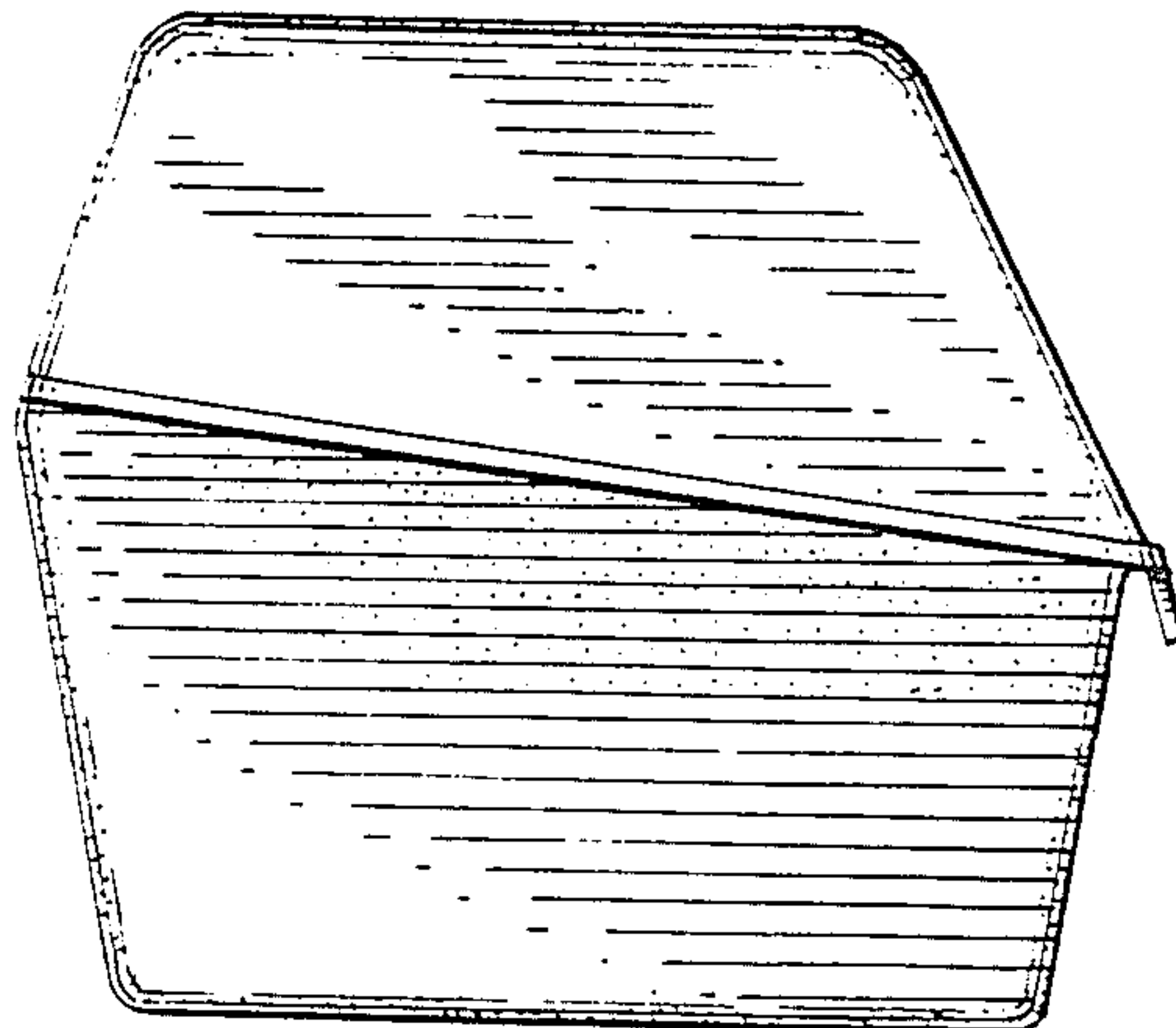

FIG. 8