

[54] COMBINED CHILD'S DESK AND PLAY CENTER

[75] Inventors: Bruce J. Benedetto, Farmington; Paul S. Santarsiero, Avon, both of Conn.

[73] Assignee: Coleco Industries, Inc., West Hartford, Conn.

[**] Term: 14 Years

[21] Appl. No.: 842,013

[22] Filed: Mar. 7, 1986

[52] U.S. Cl. D21/121; D6/425

[58] Field of Search D6/422, 423, 424, 425, D6/426, 427, 428, 440, 429, 470; D21/121; 312/194, 195, 196

[56] References Cited

U.S. PATENT DOCUMENTS

- D. 87,879 10/1932 Hunter D6/425
- D. 161,172 12/1950 Greene D6/420 X
- D. 269,196 5/1983 Appel et al. D21/121
- D. 277,019 1/1985 Appel et al. D21/121

- D. 280,684 9/1985 Cervero D6/422
- D. 282,218 1/1986 Catelli D21/121

OTHER PUBLICATIONS

Montgomery Ward Christmas Values '83, p. 23; "Strawberry Shortcake" Desk item T, center right on page. Montgomery Ward Christmas Values '83, p. 48; "Shirt Tales" Bookcase/Toychest item A, top left on page.

Primary Examiner—Carmen H. Vales

[57] CLAIM

The ornamental design for a combined child's desk and play center, as shown and described.

DESCRIPTION

FIG. 1 is a perspective view of a combined child's desk and play center showing our new design; FIG. 2 is a reduced-scale front elevational view thereof; FIG. 3 is a bottom plan view thereof; FIG. 4 is a top plan view thereof; FIG. 5 is a left side elevational view thereof; FIG. 6 is a right side elevational view thereof; FIG. 7 is a rear elevational view thereof; and FIG. 8 is a perspective view in closed position.

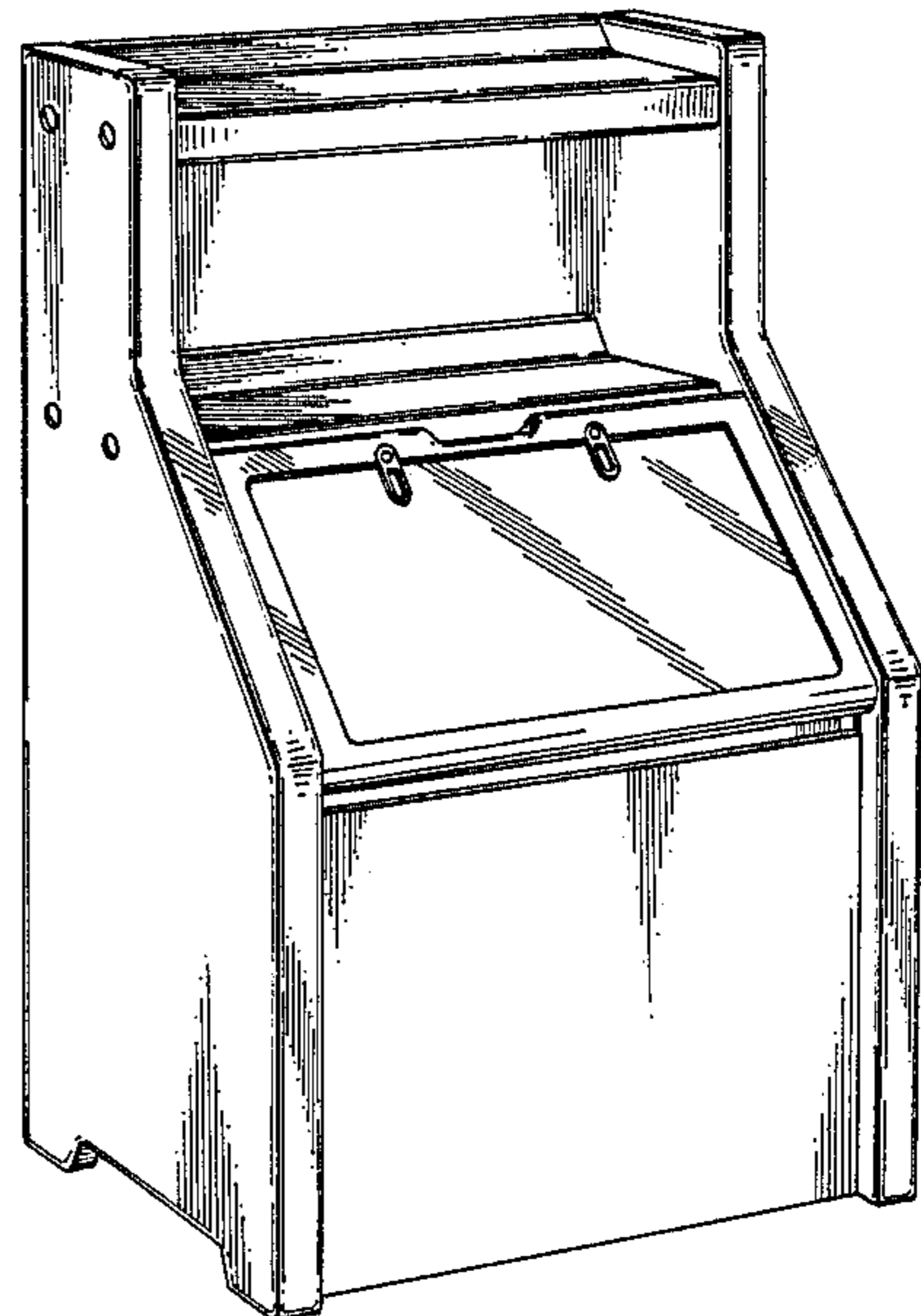
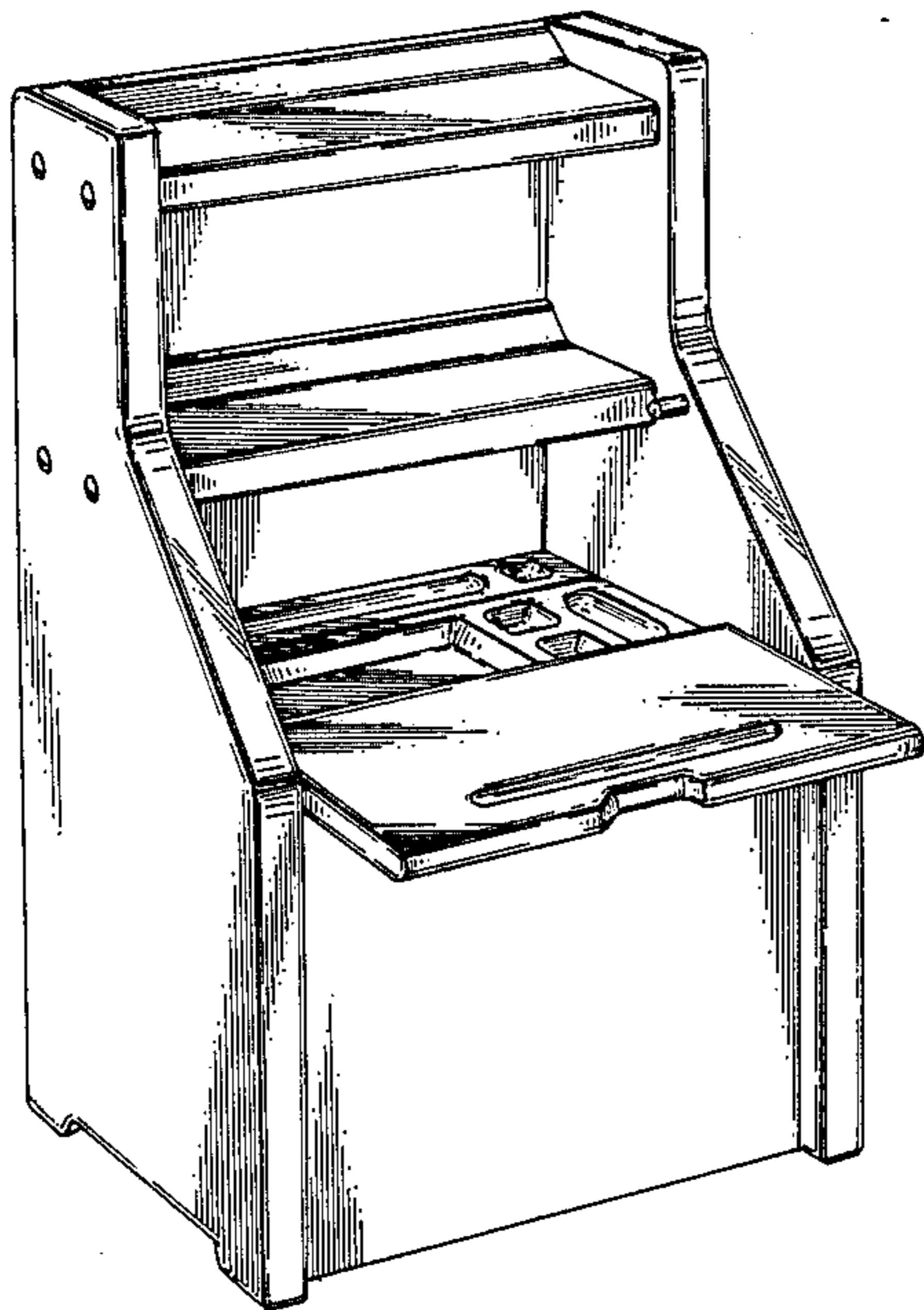

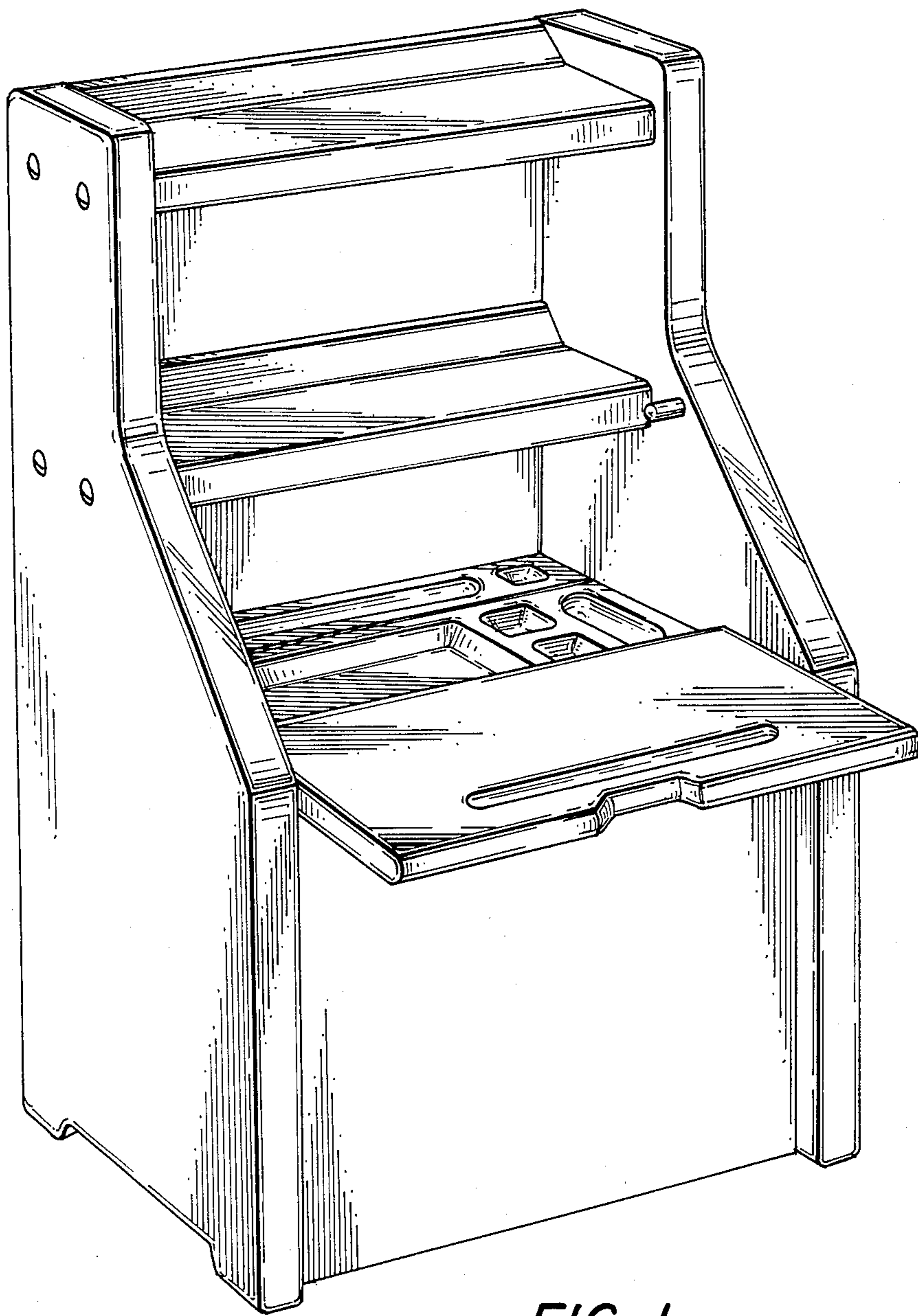

FIG. 1

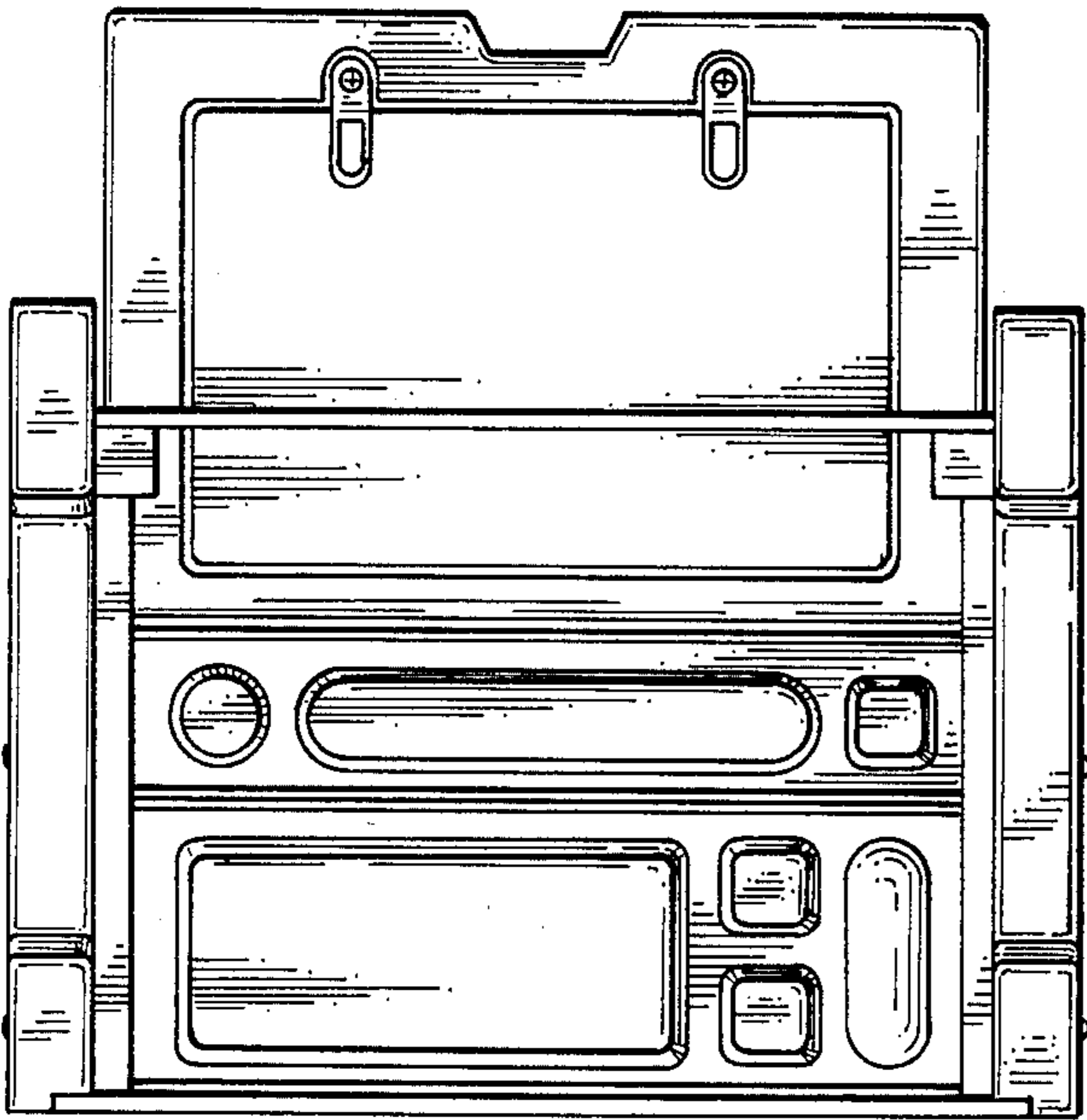

FIG. 3

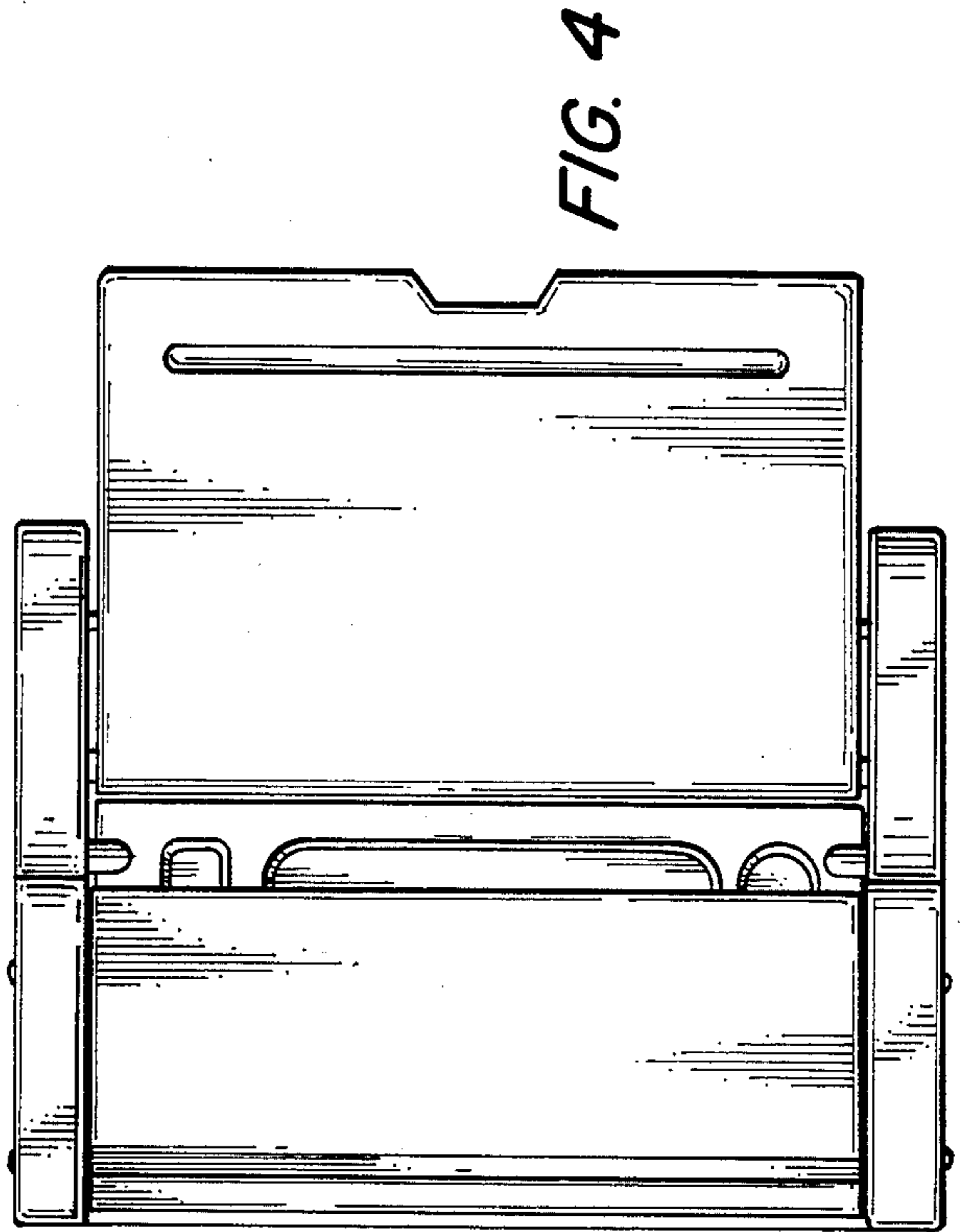

FIG. 4

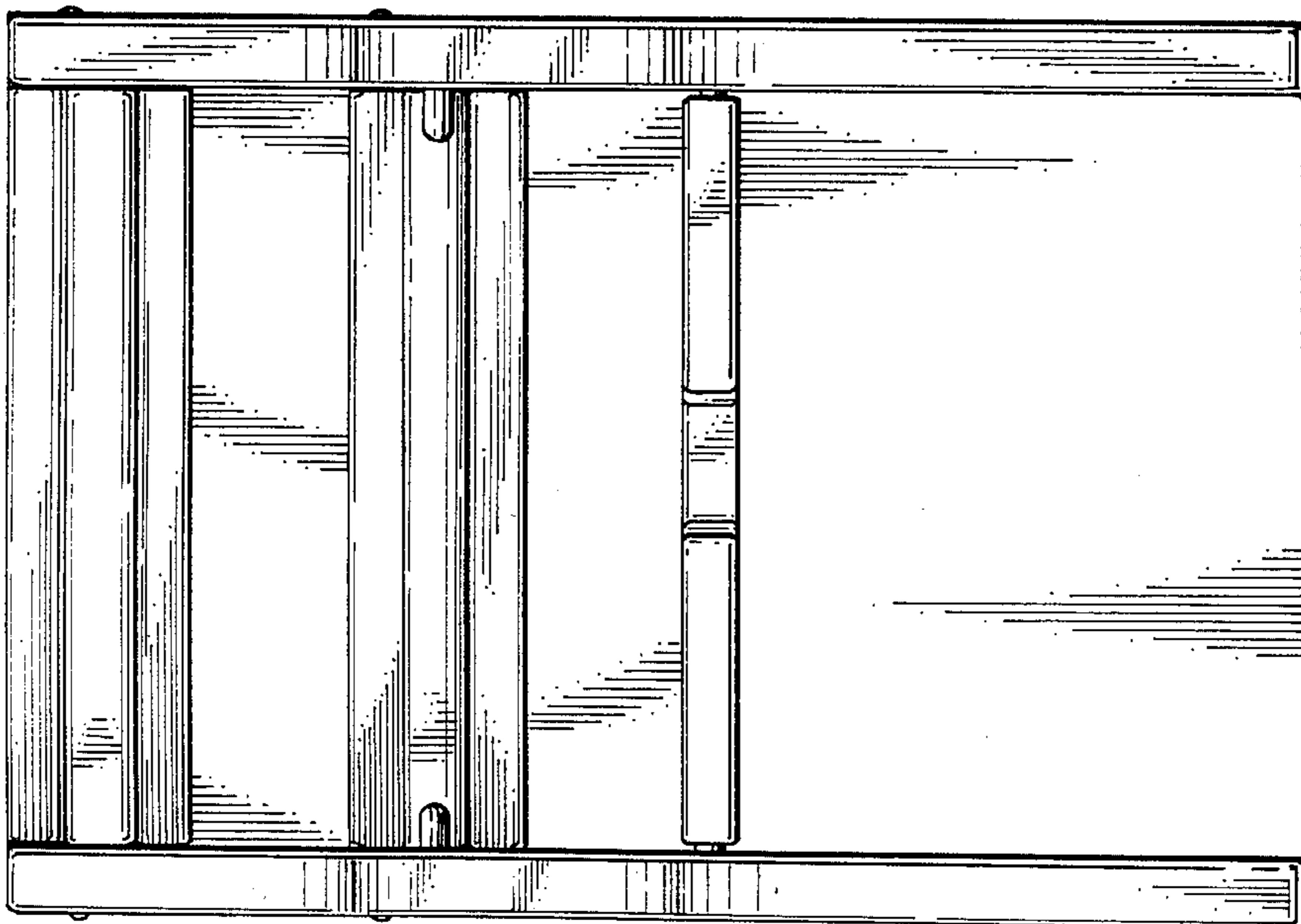

FIG. 2

FIG. 7

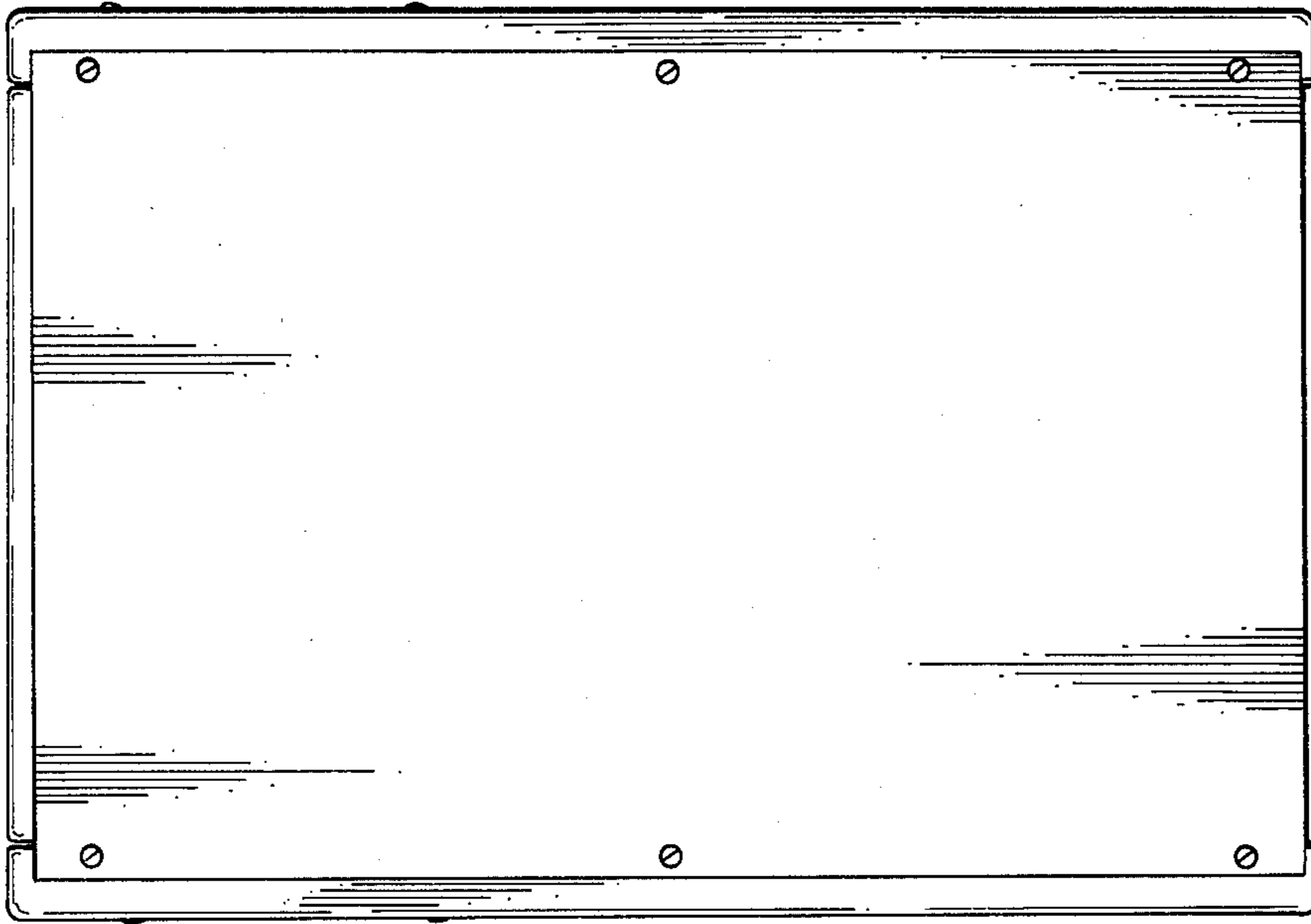

FIG. 6

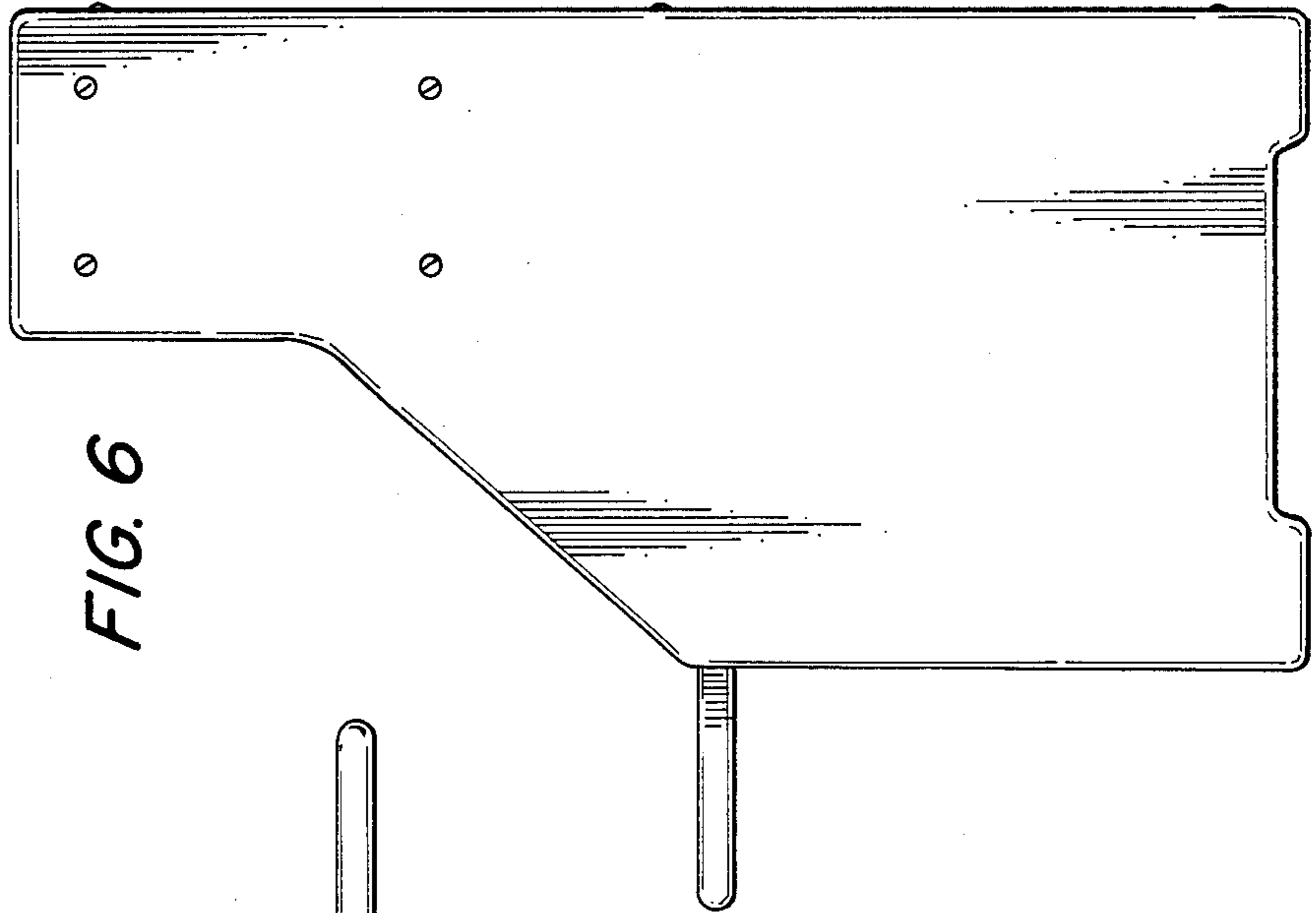
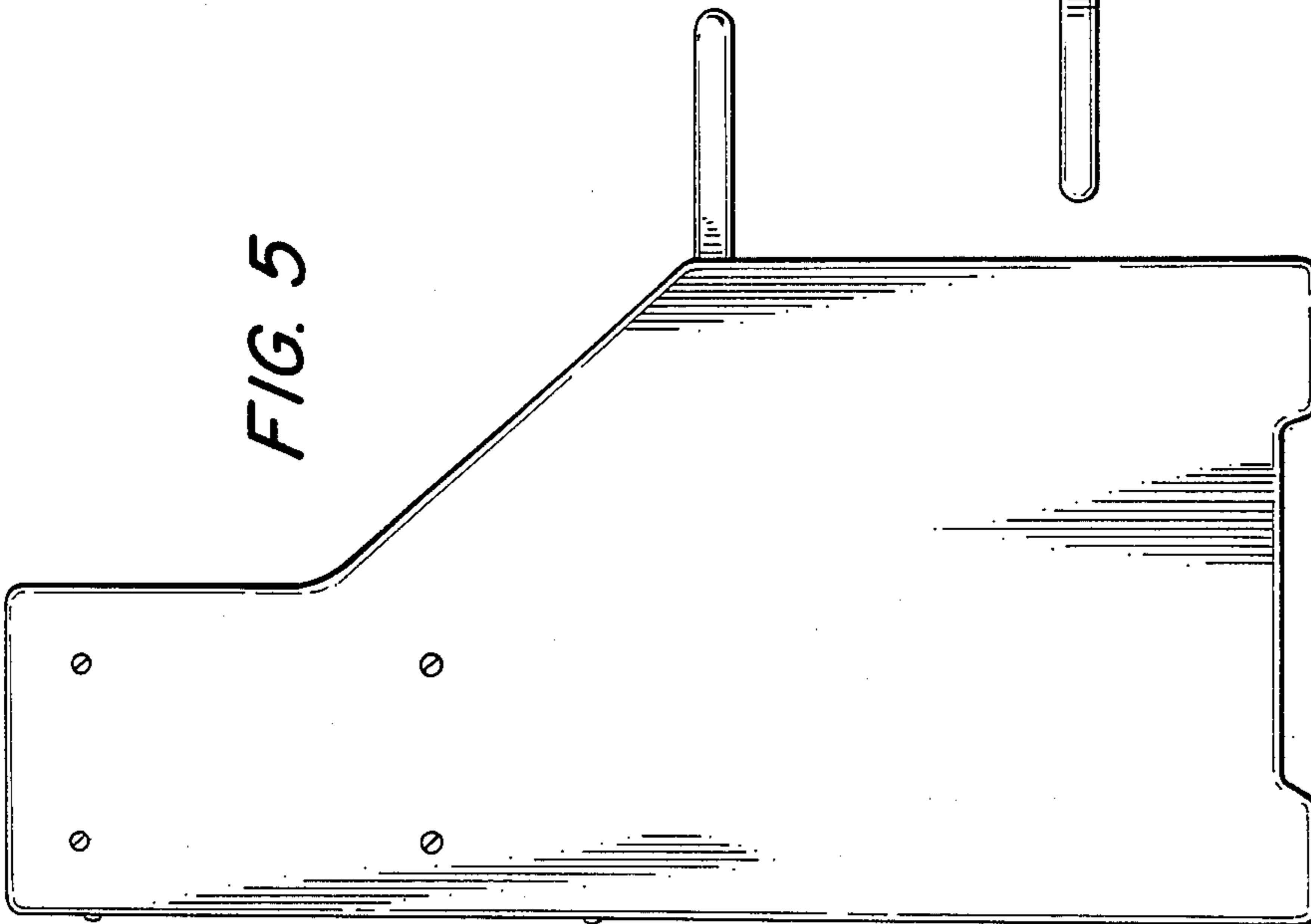

FIG. 5



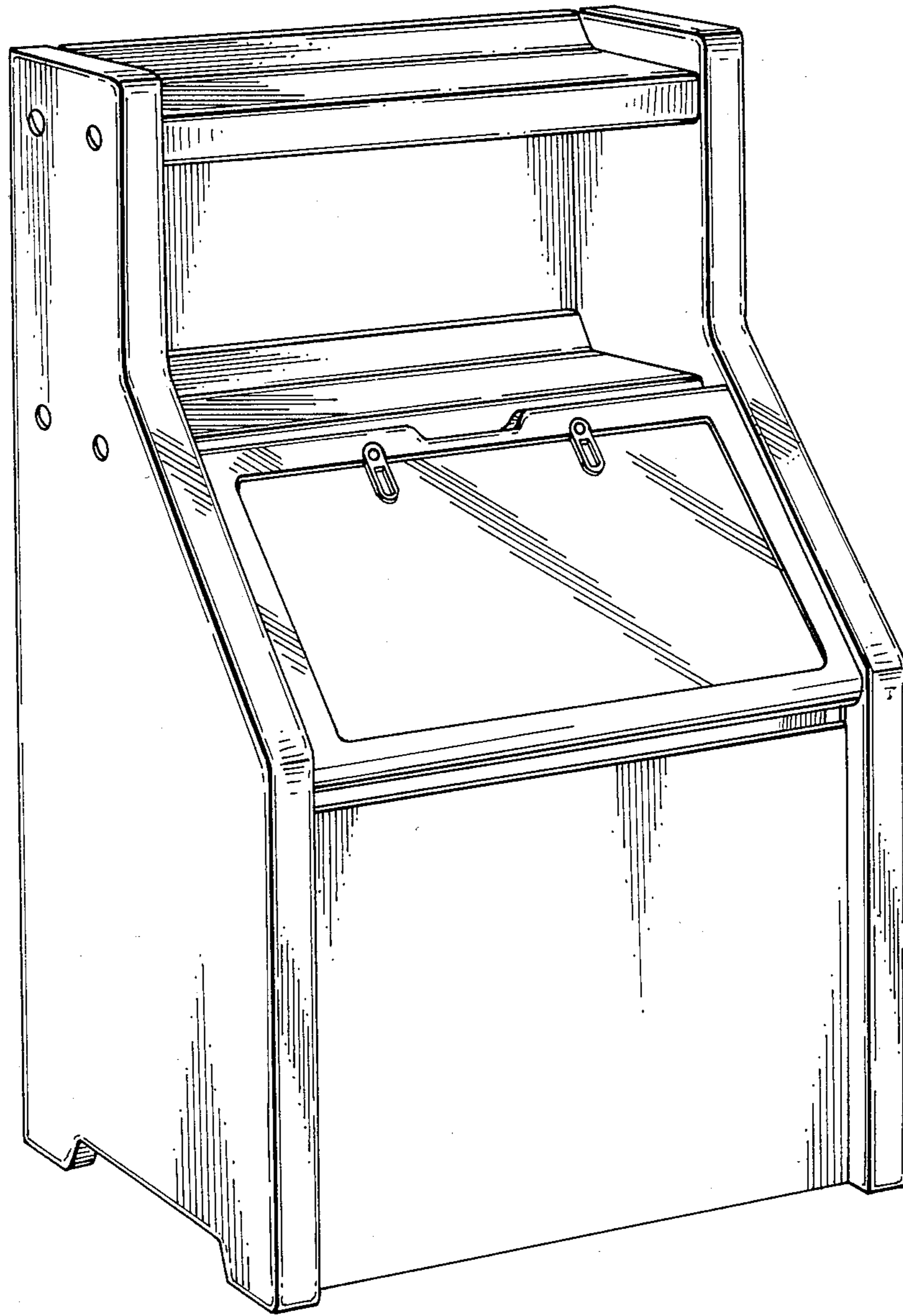

FIG. 8