

[54] **MICROPHONE**

[75] **Inventor: Kenichiro Kohno, Tokyo, Japan**  
[73] **Assignee: Sony Corporation, Tokyo, Japan**  
[\*\*] **Term: 14 Years**  
[21] **Appl. No.: 768,329**  
[22] **Filed: Aug. 22, 1985**

[30] **Foreign Application Priority Data**

Mar. 26, 1985 [JP] Japan ..... 60-12034  
[52] **U.S. Cl. .... D14/12**  
[58] **Field of Search ..... D14/3, 12, 13, 99;**  
381/91, 122, 155, 159, 168, 169, 170

[56] **References Cited**

**U.S. PATENT DOCUMENTS**

D. 195,969 8/1963 Spilman ..... D14/12  
D. 227,786 7/1973 Taylor ..... D14/12 X  
D. 271,688 12/1983 Tajima et al. .... D14/99 X  
D. 278,333 4/1985 Takata ..... D14/12  
D. 280,096 8/1985 Meister ..... D14/12

**OTHER PUBLICATIONS**

Radio Shack 1986 Catalog No. 393, p. 49, top center-Slim Solar-Powered Omnidirectional Electret.

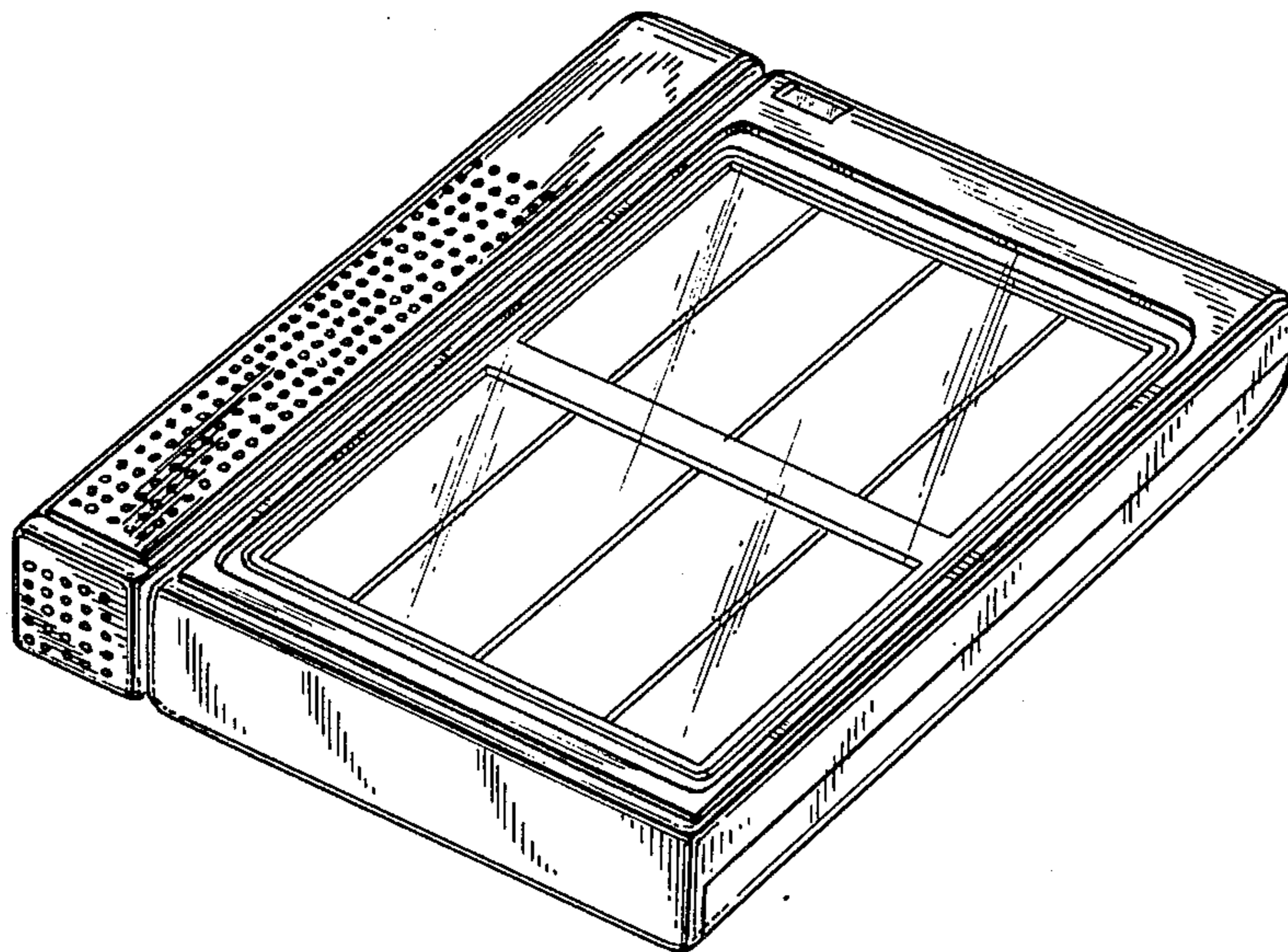
*Primary Examiner*—Bruce W. Dunkins  
*Assistant Examiner*—Theodore M. Shooman  
*Attorney, Agent, or Firm*—Lewis H. Eslinger; Jay H. Maioli

[57] **CLAIM**

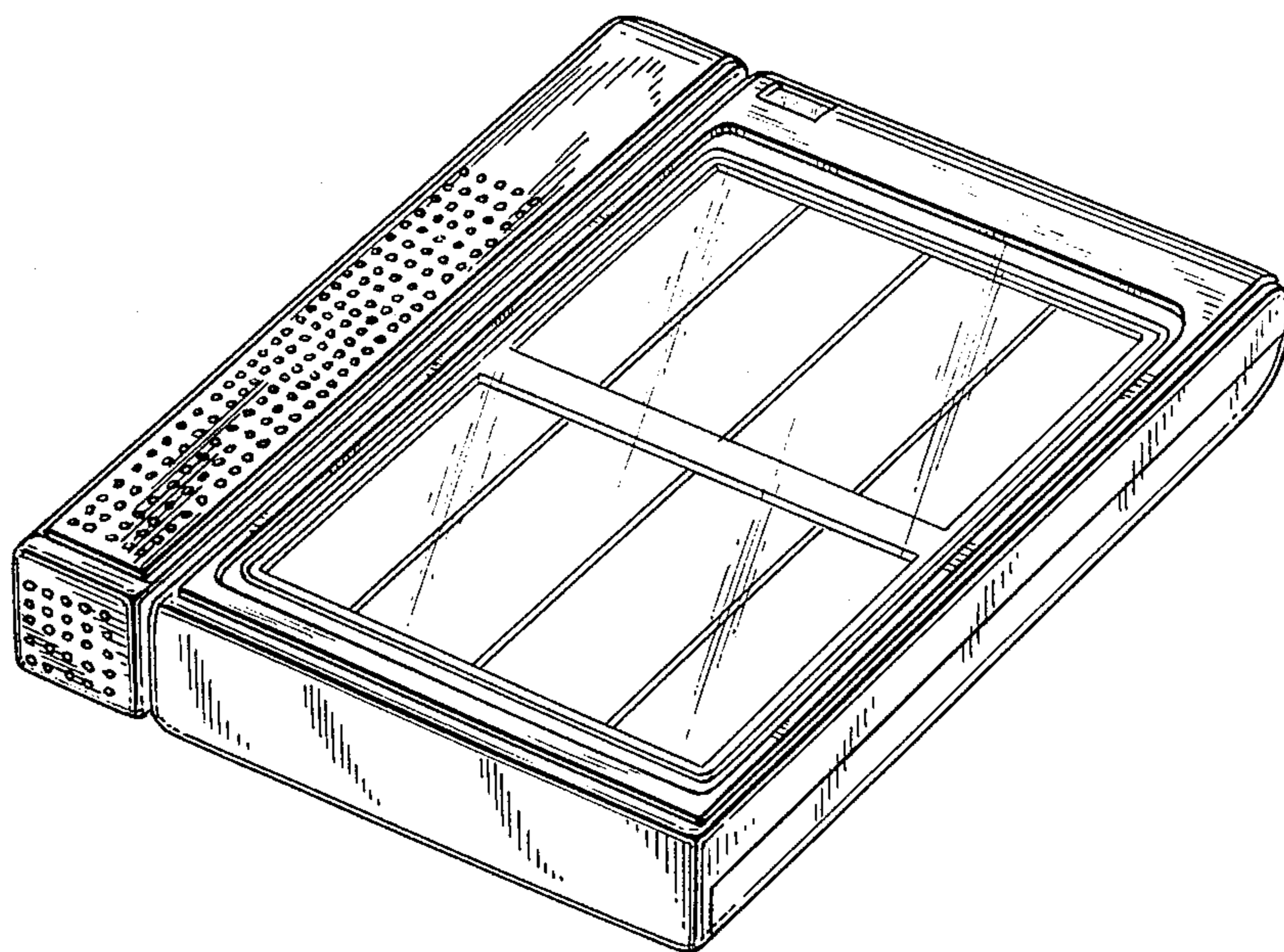
The ornamental design for a microphone, as shown and described.

**DESCRIPTION**

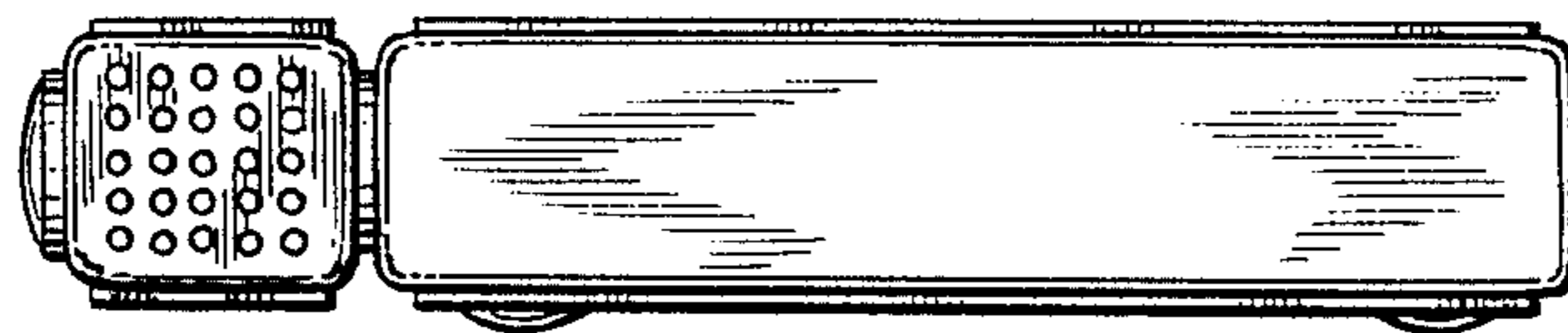
FIG. 1 is a top, front, and right-side perspective view of a microphone showing my new design; FIG. 2 is a front elevational view thereof; FIG. 3 is a rear elevational view thereof; FIG. 4 is a left-side elevational view thereof; FIG. 5 is a right-side elevational view thereof; FIG. 6 is a top plan view thereof; FIG. 7 is a bottom plan view thereof; and FIG. 8 is a top, front, and right-side perspective view thereof, shown with the left portion in an alternate position. The left-side of the housing not shown being a mirror image of the right side.

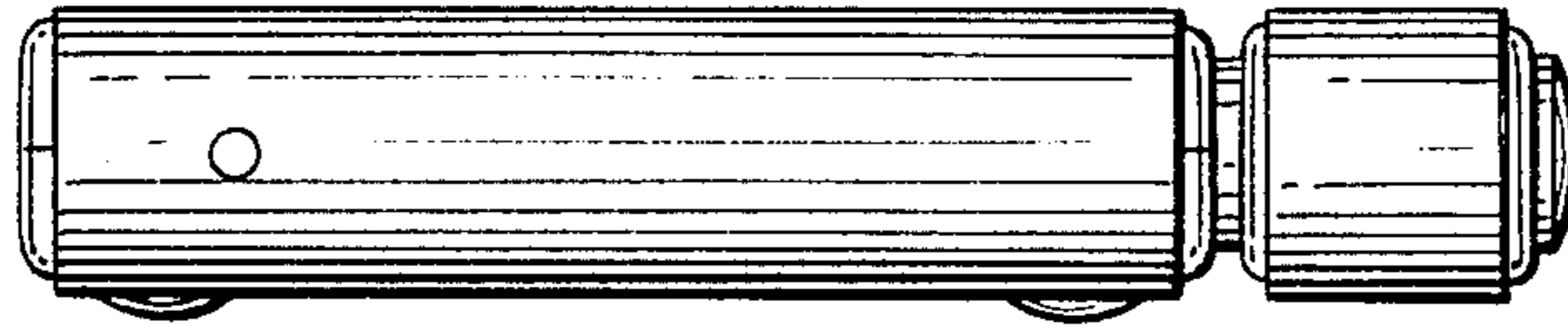


*FIG. 1*

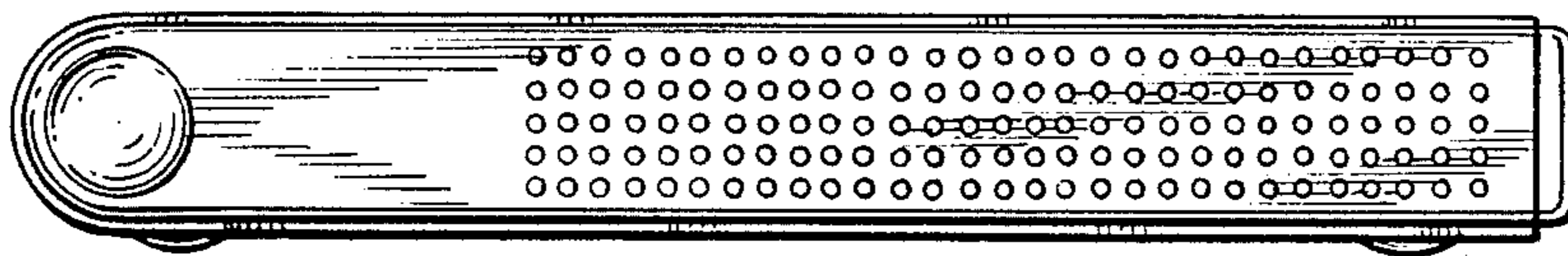


*FIG. 2*



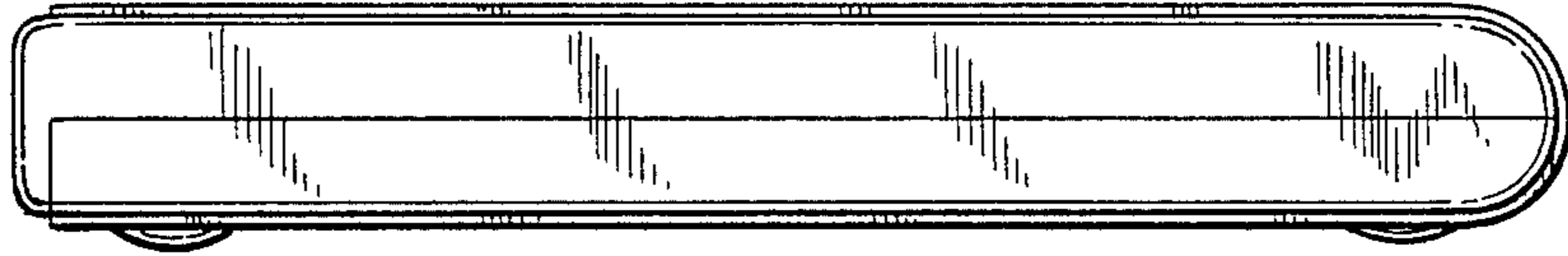


*FIG. 3*

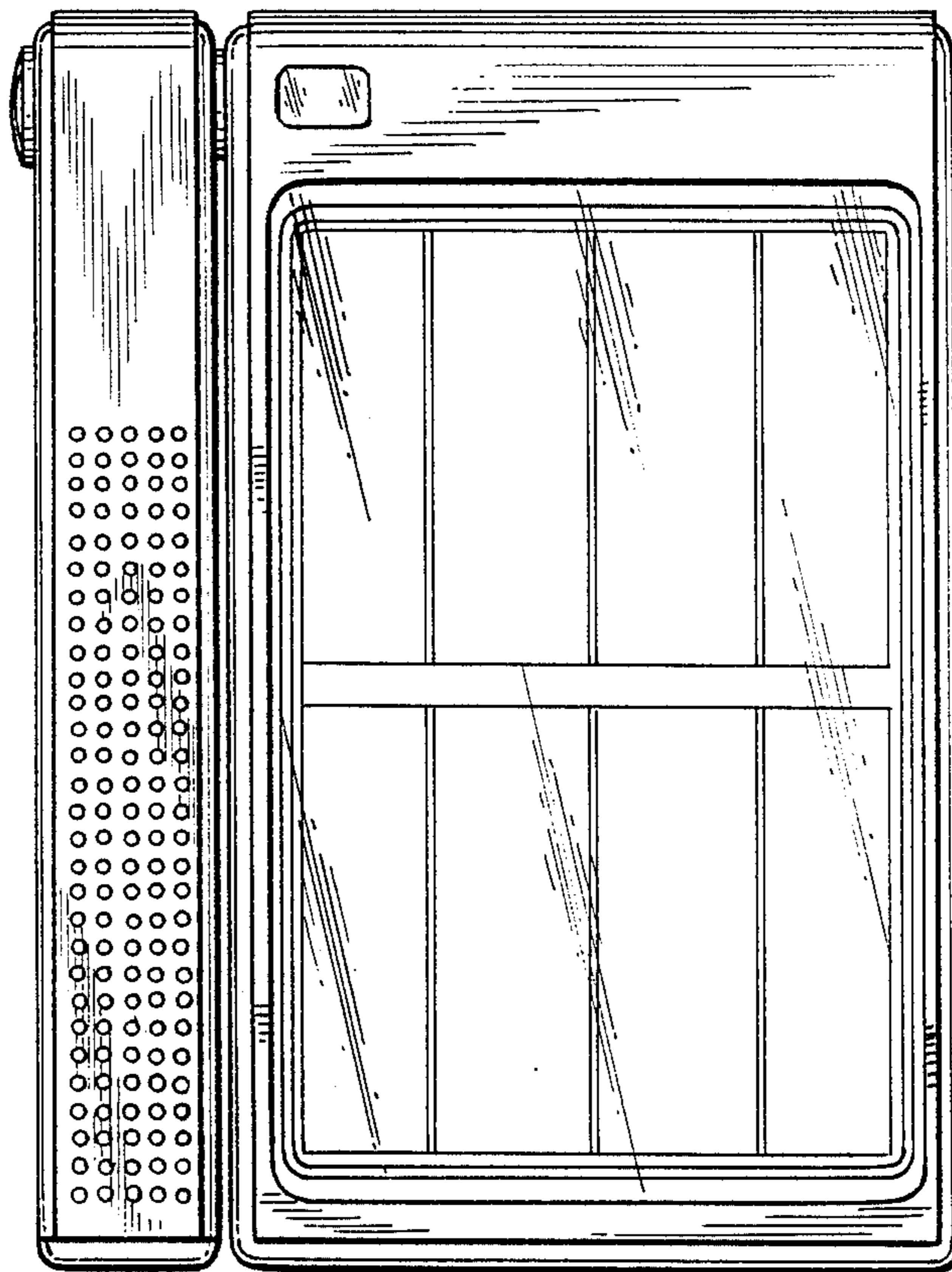


*FIG. 4*

*FIG. 5*

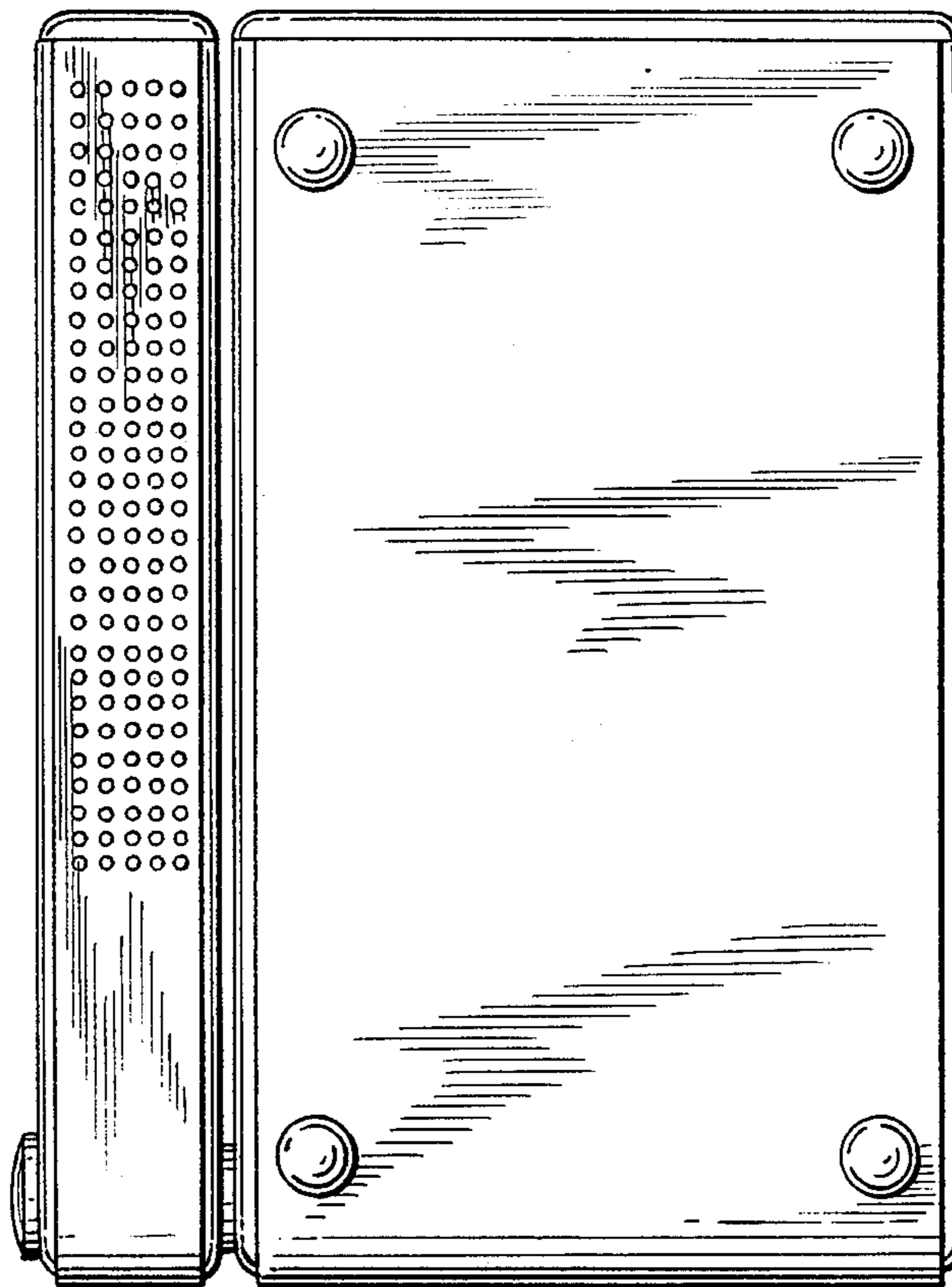


*FIG. 6*





*FIG. 7*



*FIG. 8*

