

[54] **MEGAPHONE**

[75] **Inventor: Tsutomu Tajima, Tokyo, Japan**

[73] **Assignee: Kabushiki Kaisha Tajima Sangyo, Tokyo, Japan**

[**] **Term: 14 Years**

[21] **Appl. No.: 806,689**

[22] **Filed: Dec. 9, 1985**

[30] **Foreign Application Priority Data**

Jun. 14, 1985 [JP] Japan 60-25151

[52] **U.S. Cl. D14/35; D14/99; D21/211**

[58] **Field of Search D14/30-37, D14/39, 99; D21/211, 210; 181/177**

[56] **References Cited**

U.S. PATENT DOCUMENTS

D. 67,239 5/1925 Skinner D14/35

D. 283,772 5/1986 Vail D14/35 X
2,340,156 1/1944 Taylor et al. D21/211 X
4,329,905 5/1982 Lloyd 181/177 X

Primary Examiner—Bernard Ansher
Assistant Examiner—Theodore M. Shooman
Attorney, Agent, or Firm—R. Gale Rhodes, Jr.

[57] **CLAIM**

The ornamental design for megaphone, as shown and described.

DESCRIPTION

FIG. 1 is a front elevational view of a megaphone showing my new design;
FIG. 2 is a right side elevational view thereof;
FIG. 3 is a top plan view thereof;
FIG. 4 is a bottom plan view thereof;
FIG. 5 is a left side elevational view thereof;
FIG. 6 is a rear elevational view thereof;
FIG. 7 is a bottom and front perspective view thereof;
and,
FIG. 8 is a top and rear perspective view thereof.

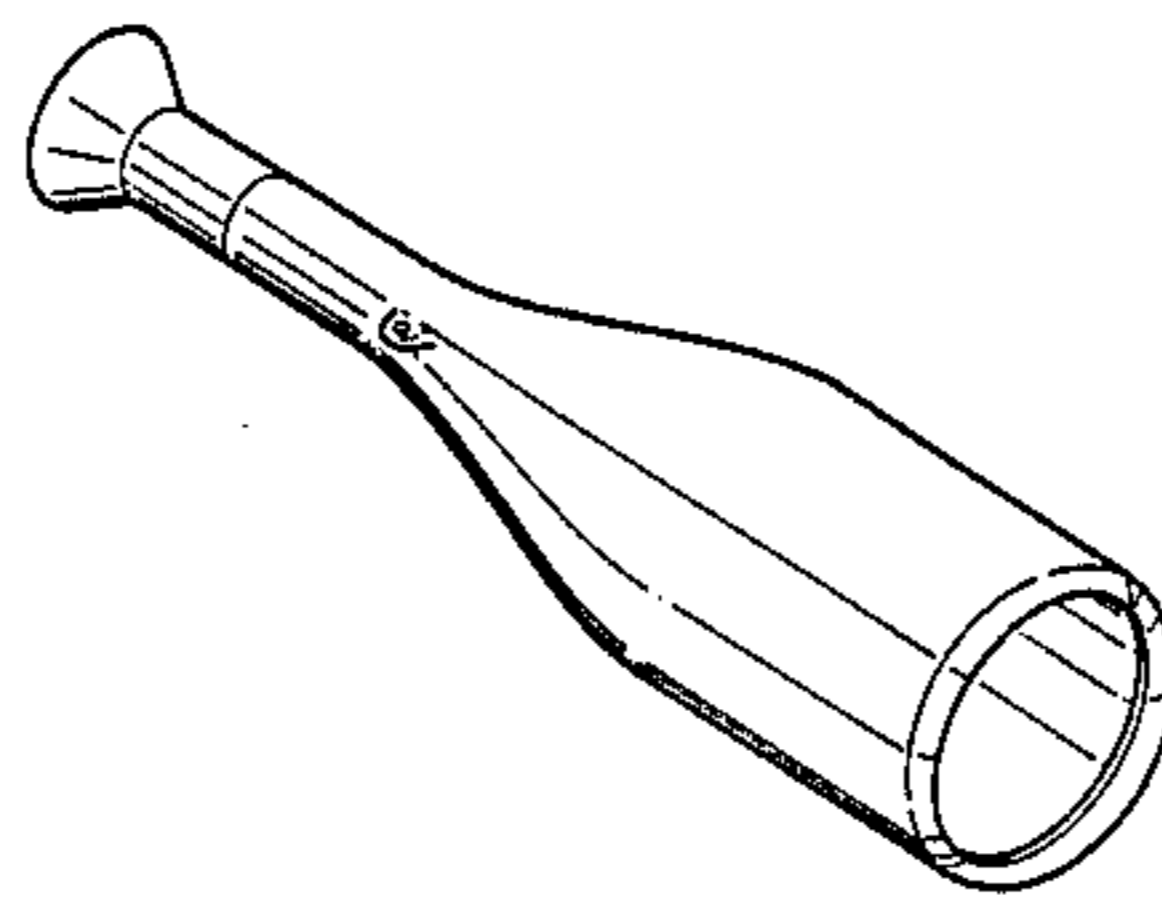
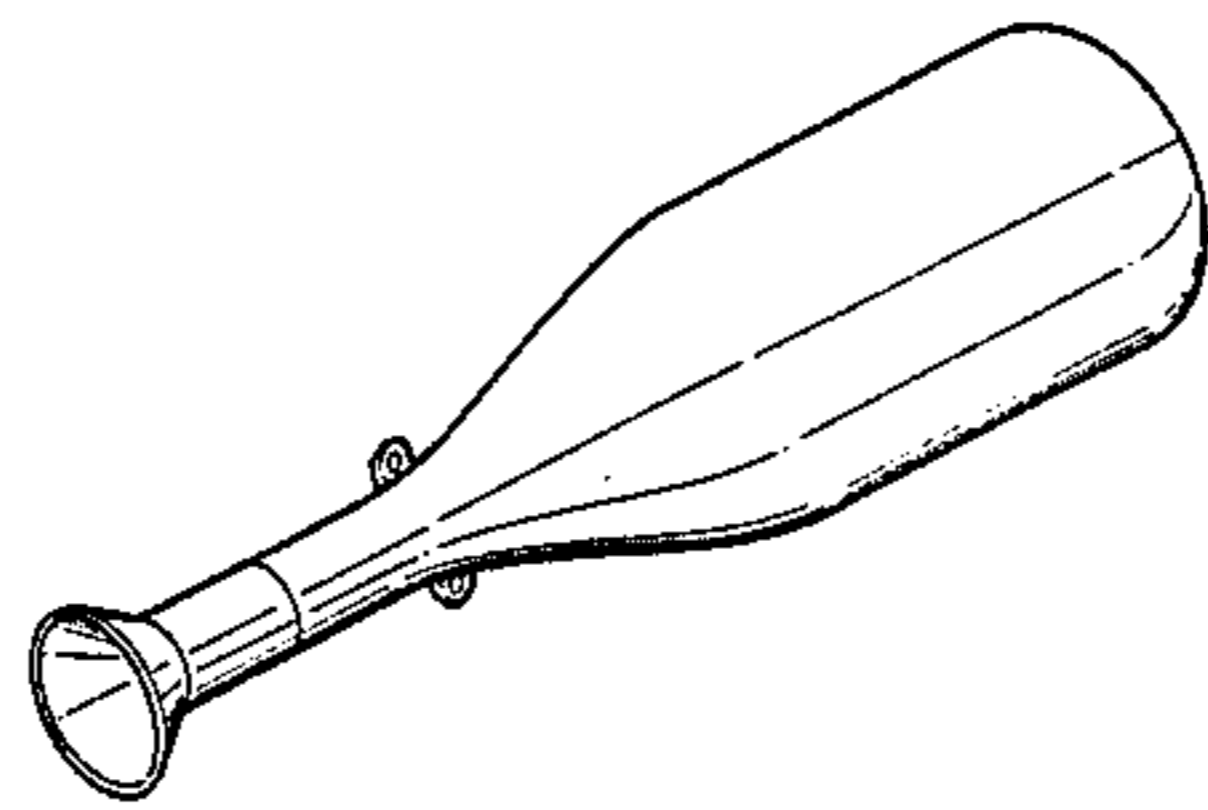

FIG. 3

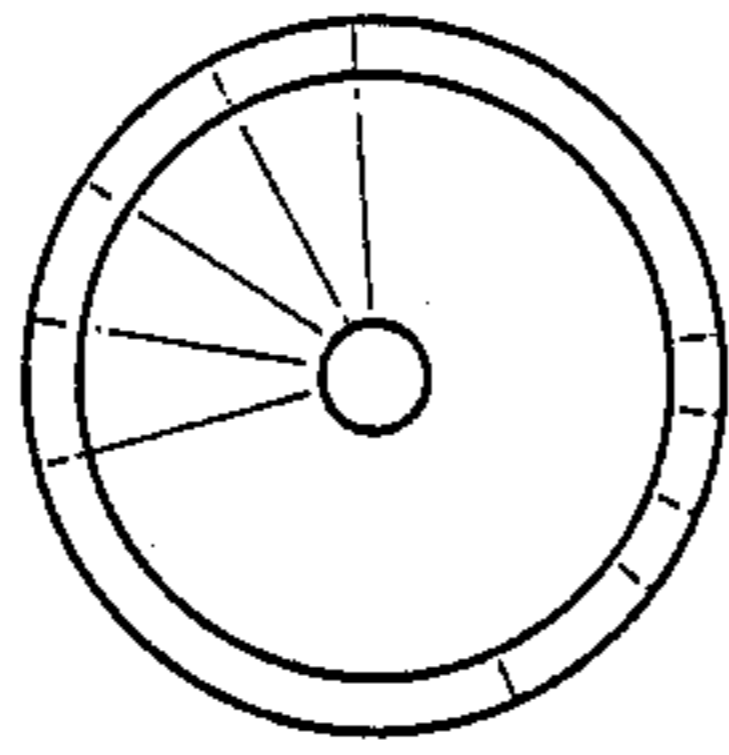

FIG. 1

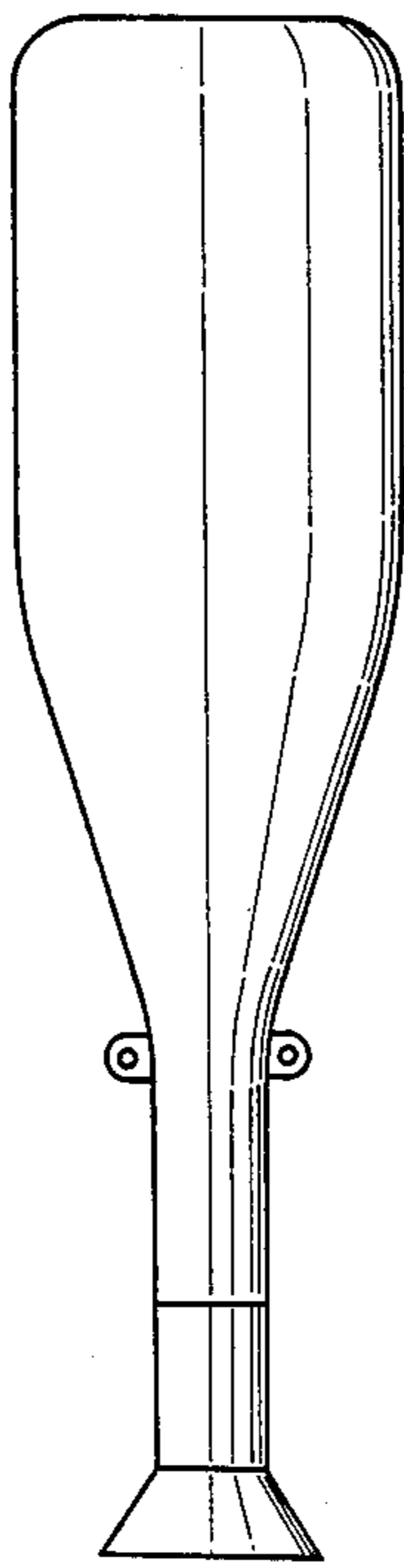

FIG. 2

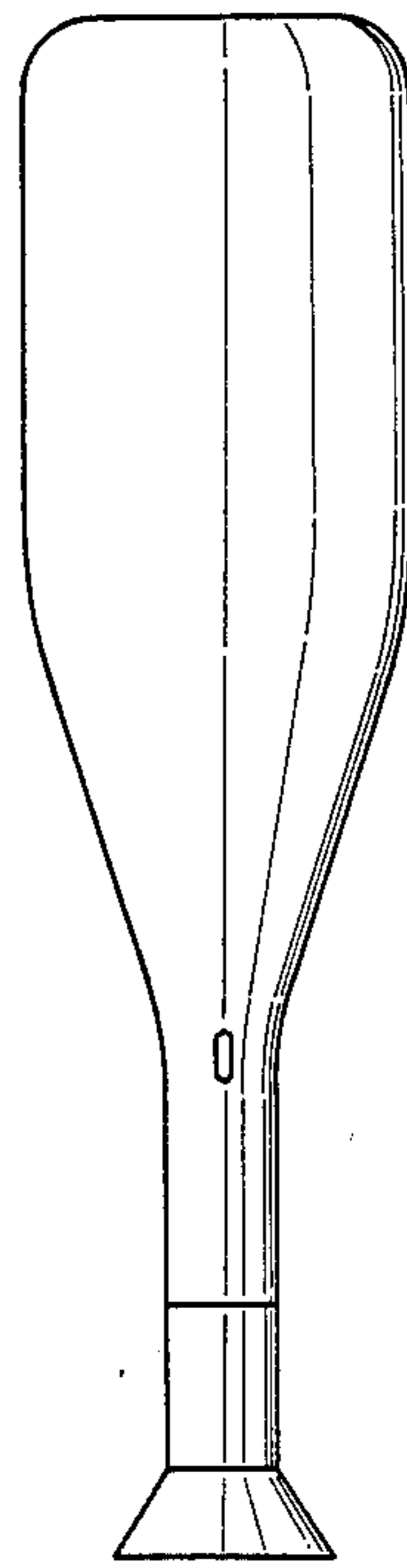

FIG. 4

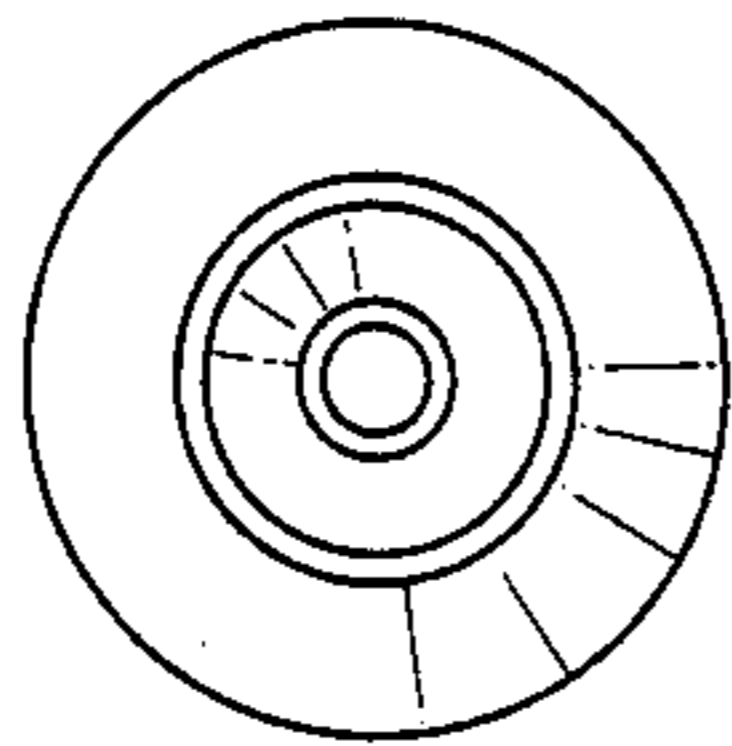

FIG. 5

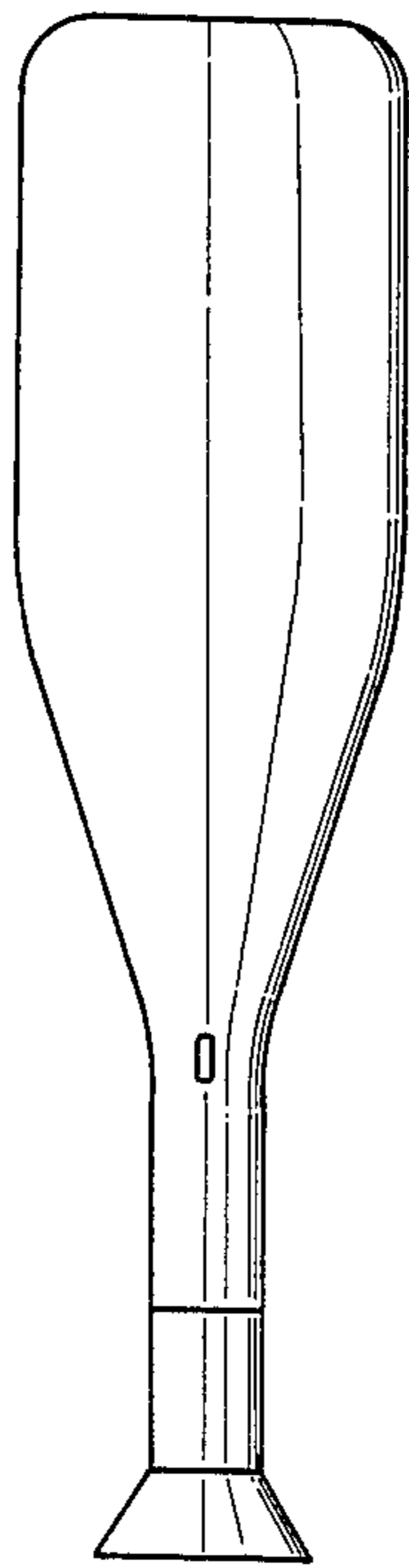

FIG. 6

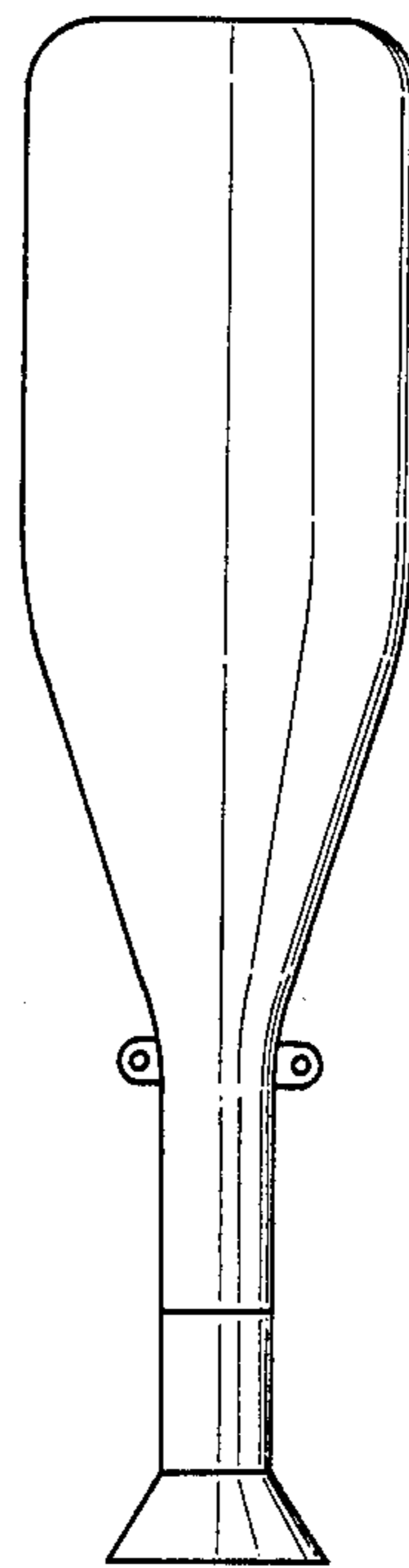

FIG. 7

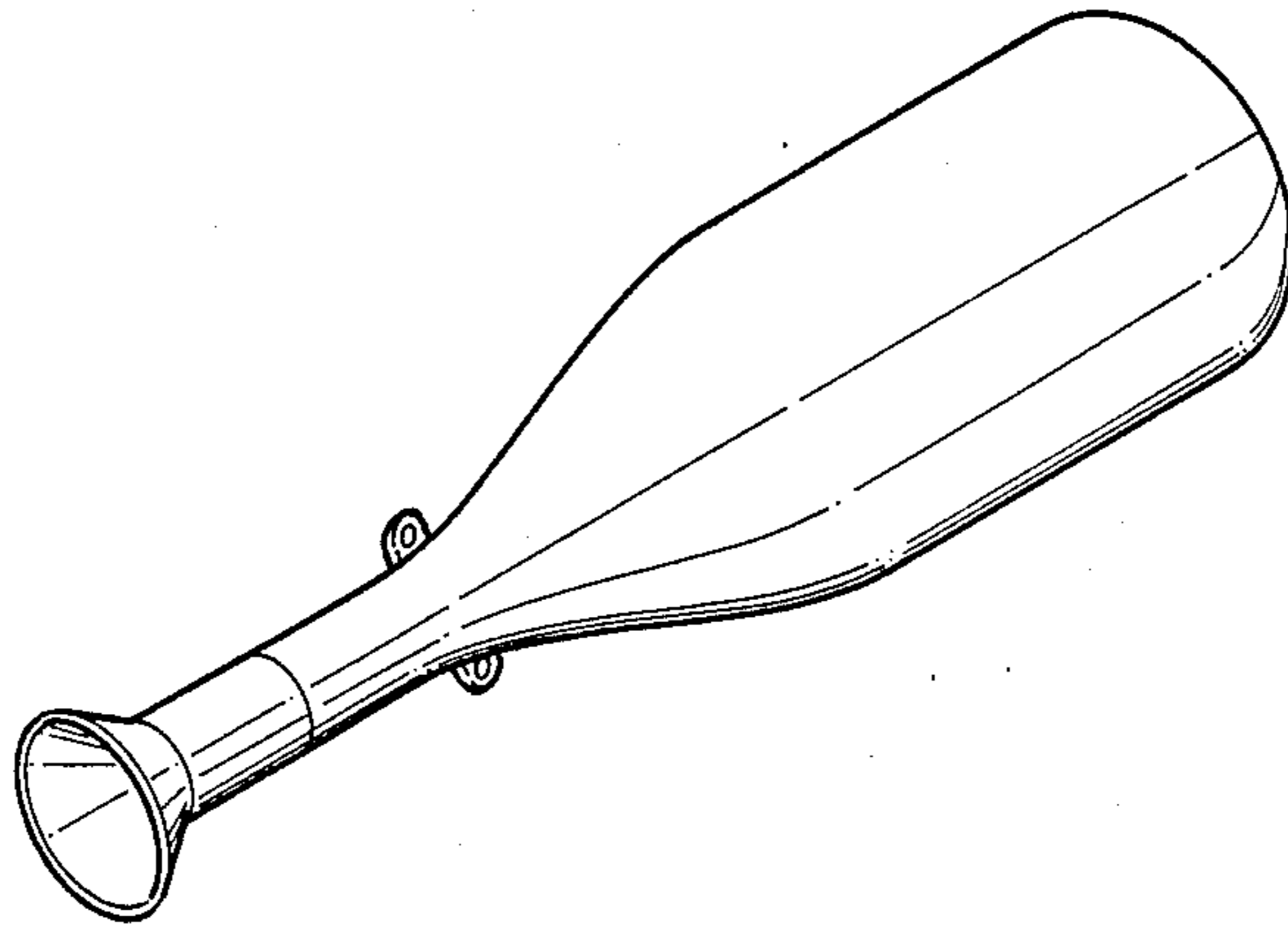

FIG. 8

