

[54] **CHAIR**

D. 278,869 5/1985 Bohl D6/366

[75] **Inventor: Mario Bellini, Milan, Italy**

[73] **Assignee: Fehlbaum & Co., Riehen, Switzerland**

[**] **Term: 14 Years**

[21] **Appl. No.: 726,470**

[22] **Filed: Apr. 24, 1985**

[30] **Foreign Application Priority Data**

Oct. 26, 1984 [CH] Switzerland DM/004341

[52] **U.S. Cl. D6/366**

[58] **Field of Search D6/364, 365, 366, 367; 297/296, 297, 298, 311, 411, 421**

[56] **References Cited**

U.S. PATENT DOCUMENTS

D. 268,233 3/1983 Stephens D6/366

D. 273,730 5/1984 Cafiero D6/366

OTHER PUBLICATIONS

Industrial Design, Jul./Aug., 1983, p. 24, Chair in panel 3.

Primary Examiner—Bruce W. Dunkins
Attorney, Agent, or Firm—Ladas & Parry

[57] **CLAIM**

The ornamental design for a chair, as shown and described.

DESCRIPTION

FIG. 1 is a front perspective view of a chair showing my new design;

FIG. 2 is a front elevational view thereof;

FIG. 3 is a rear elevational view thereof;

FIG. 4 is a right hand side elevational view thereof;

FIG. 5 is a left hand side elevational view thereof;

FIG. 6 is a bottom plan view thereof;

FIG. 7 is a partial front view thereof; and

FIG. 8 is a partial rear elevational view thereof.

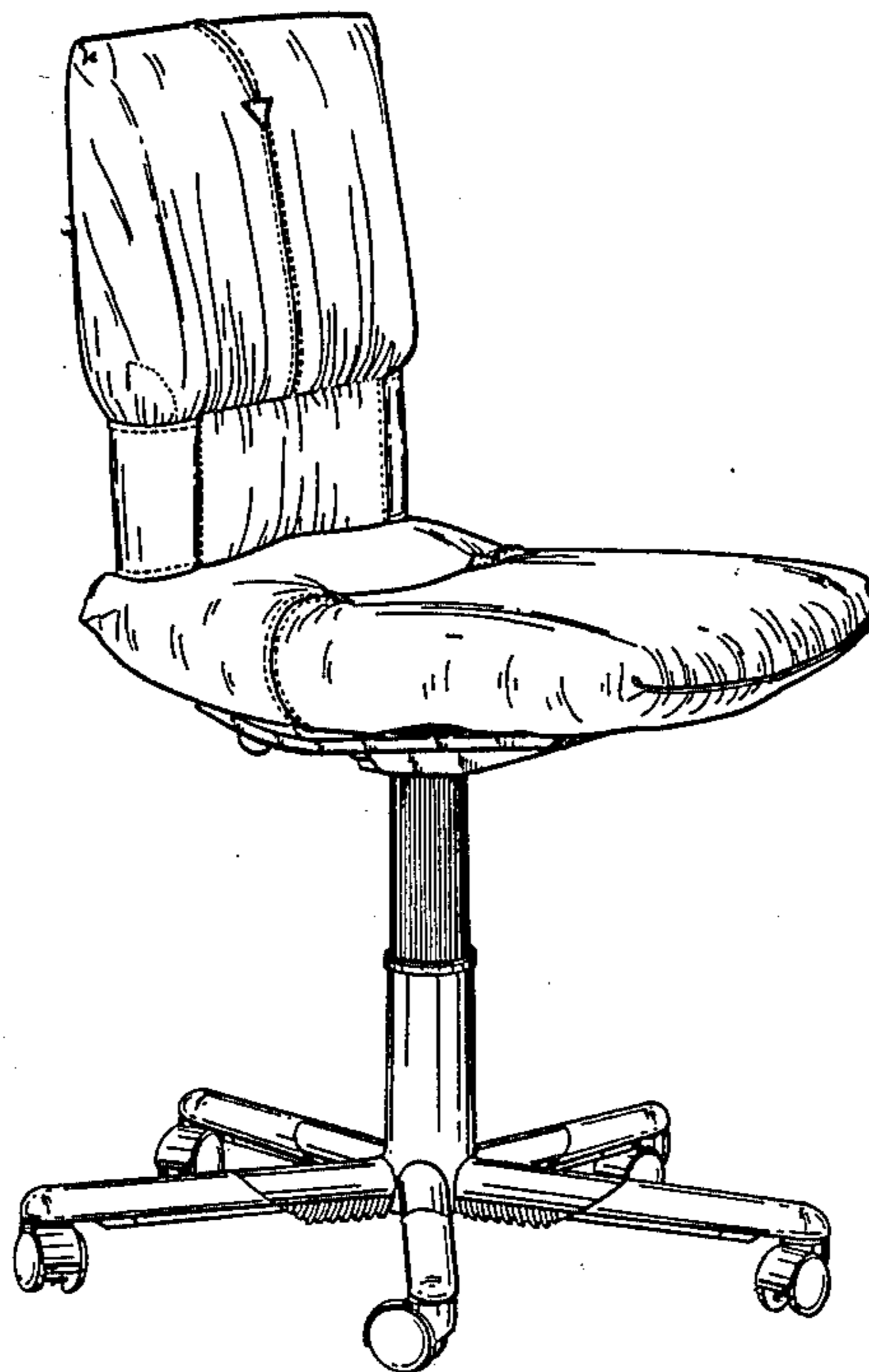

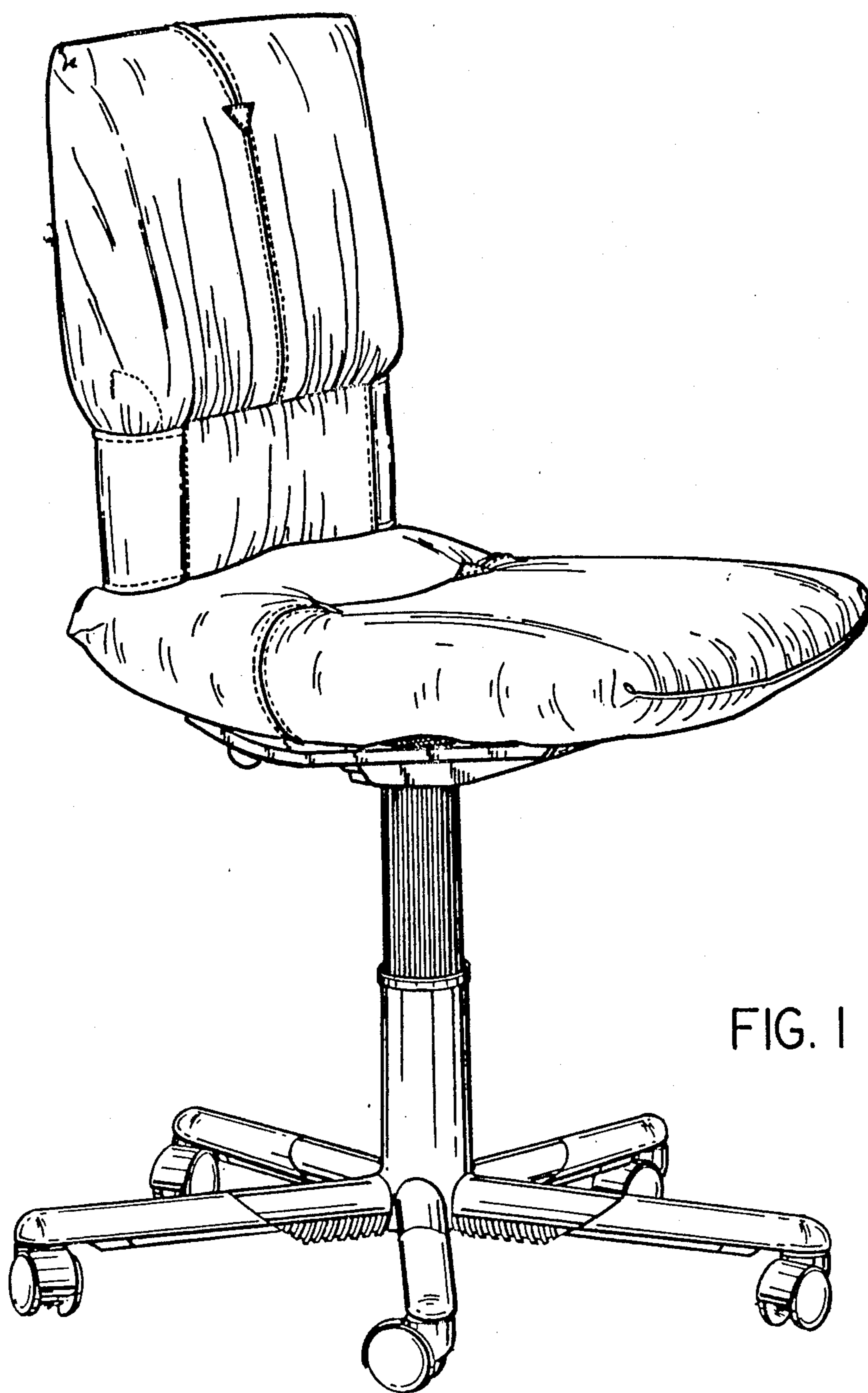

FIG. 1

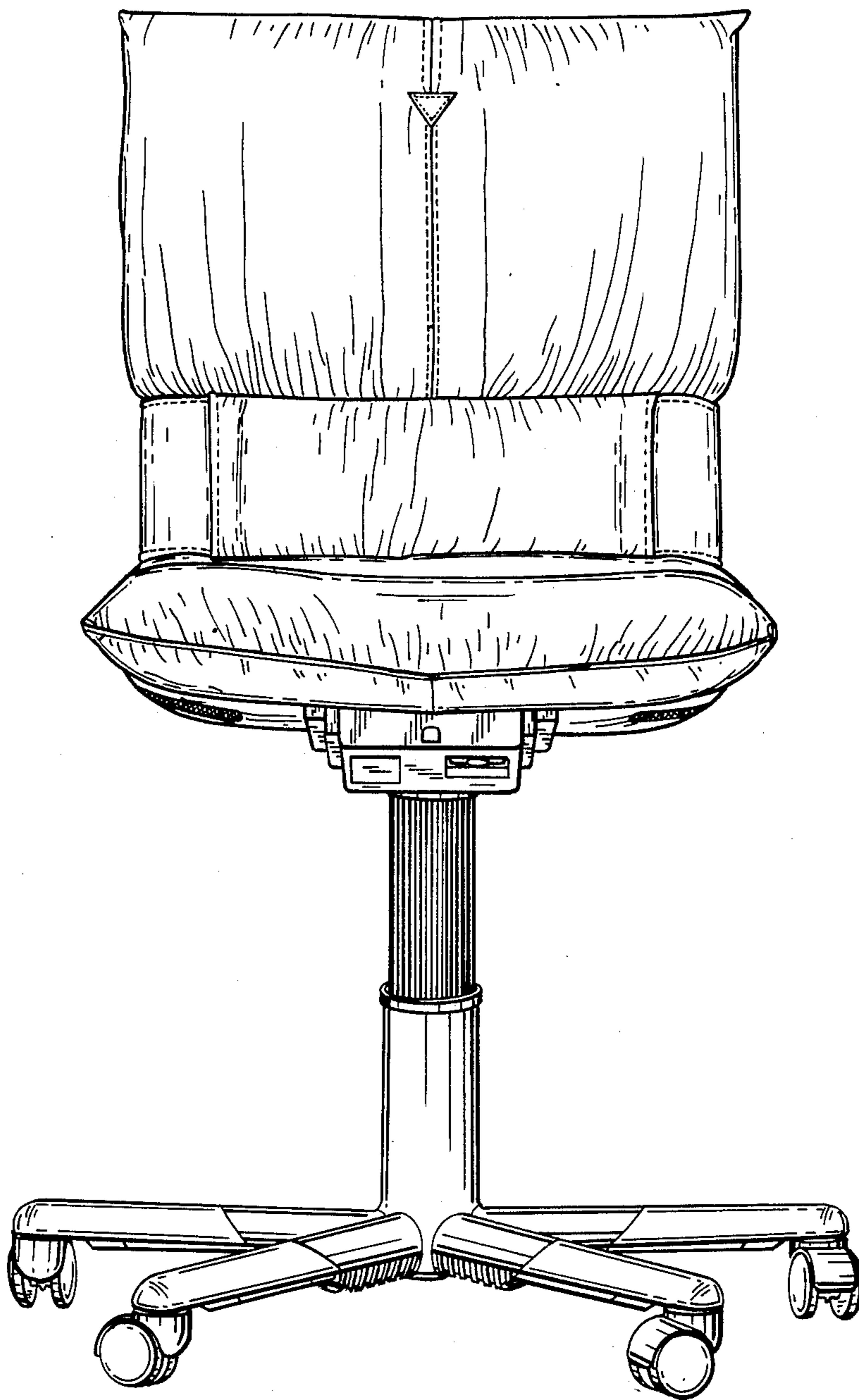

FIG. 2

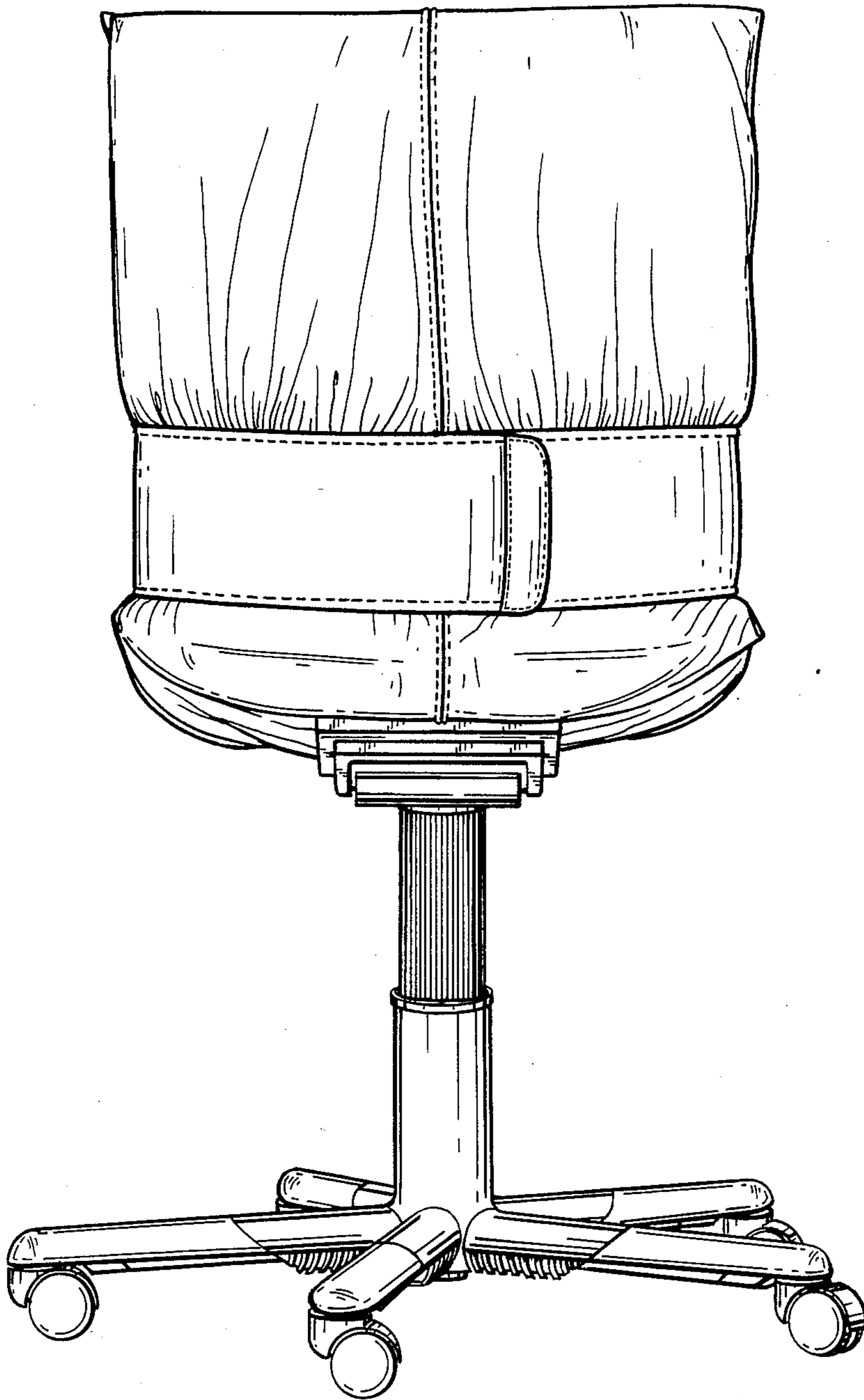

FIG. 3

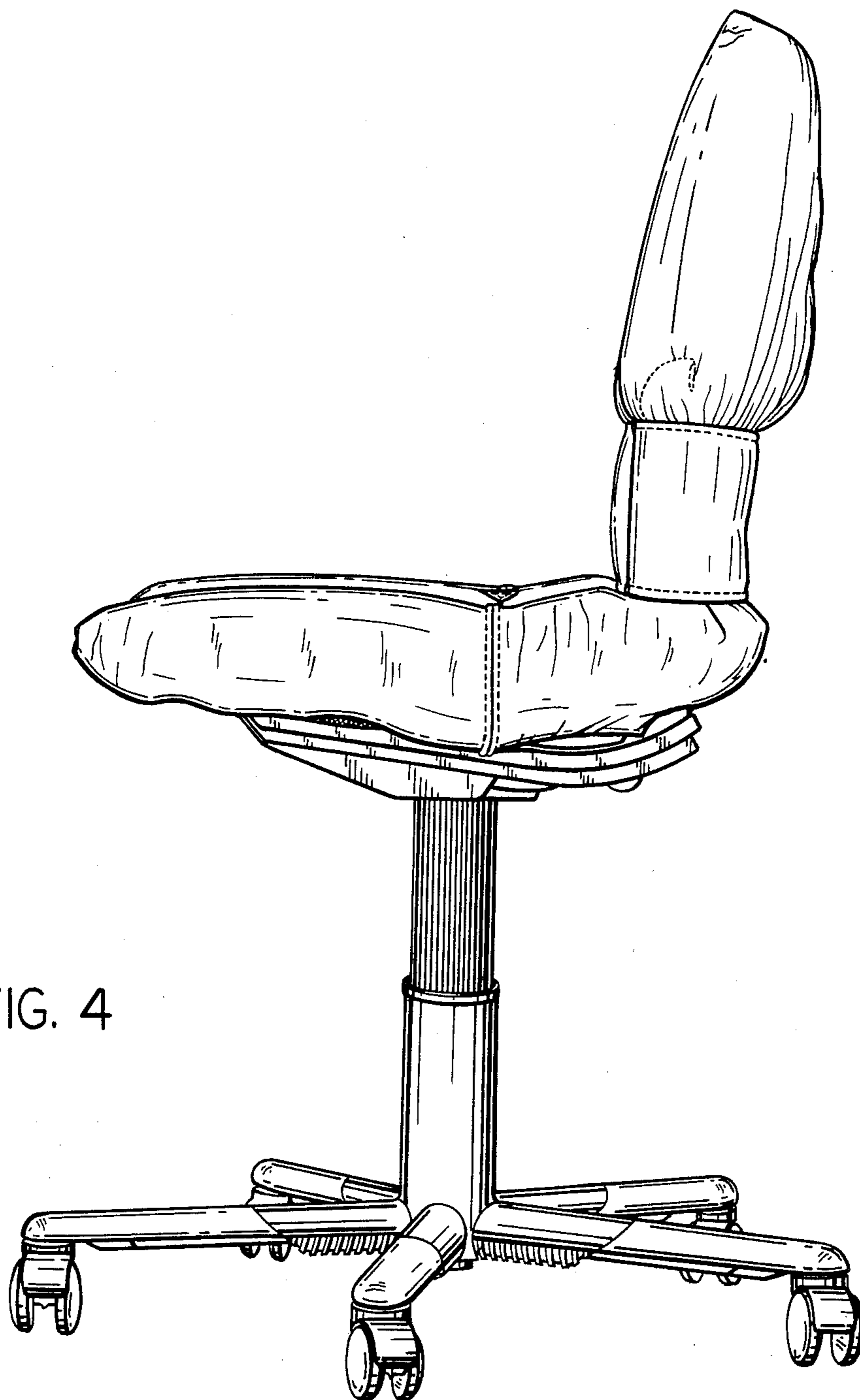

FIG. 4

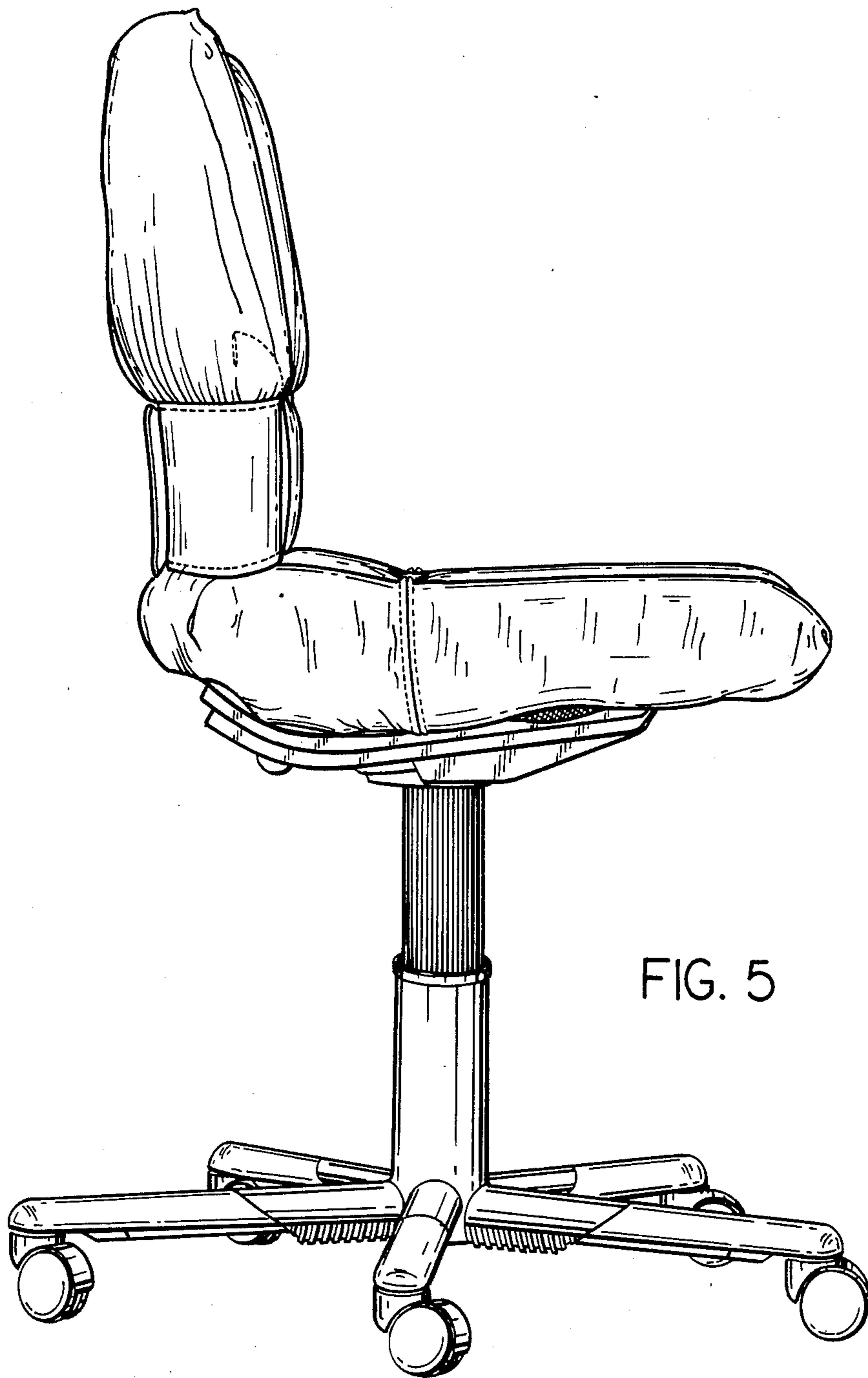

FIG. 5

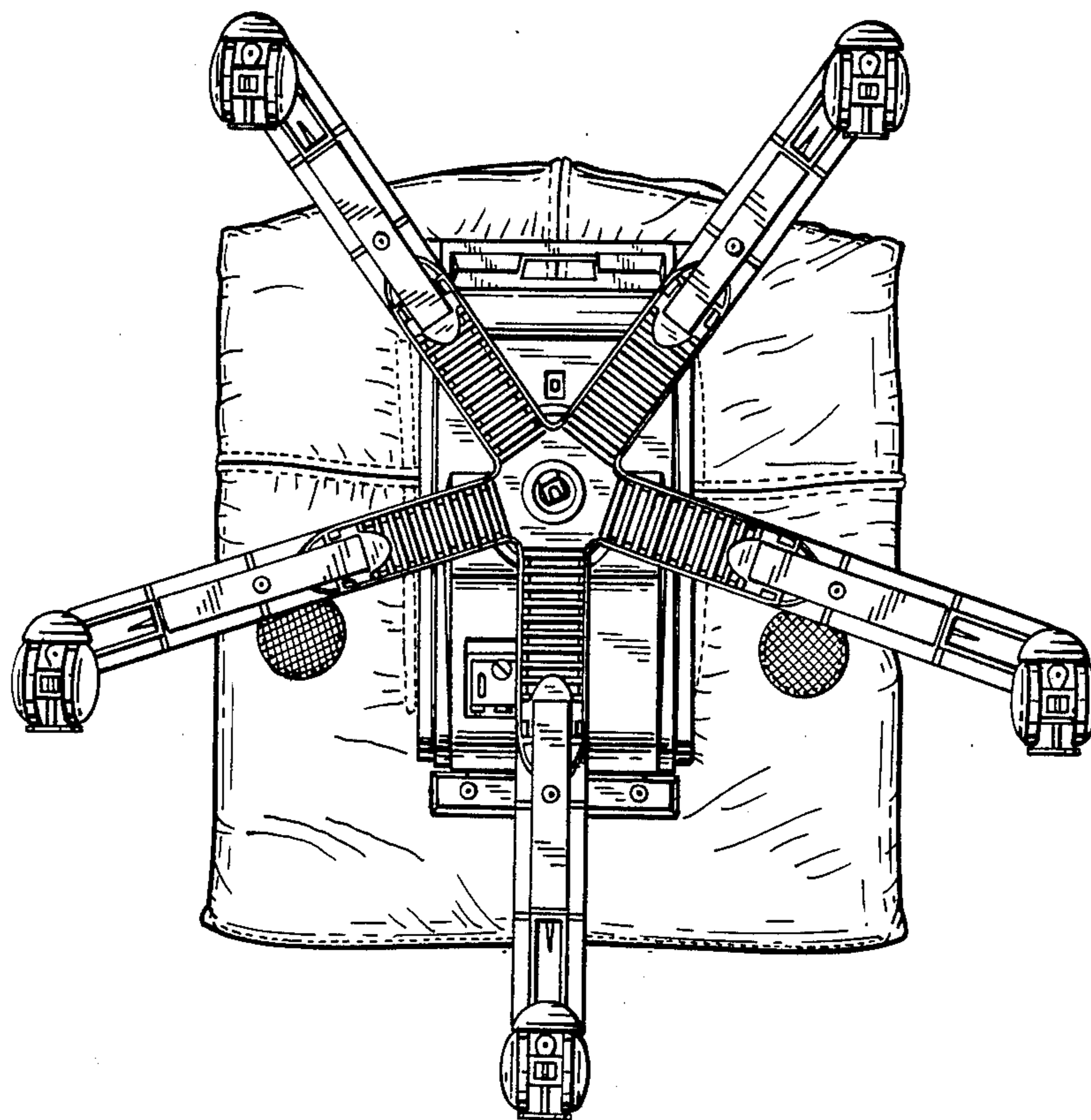

FIG. 6

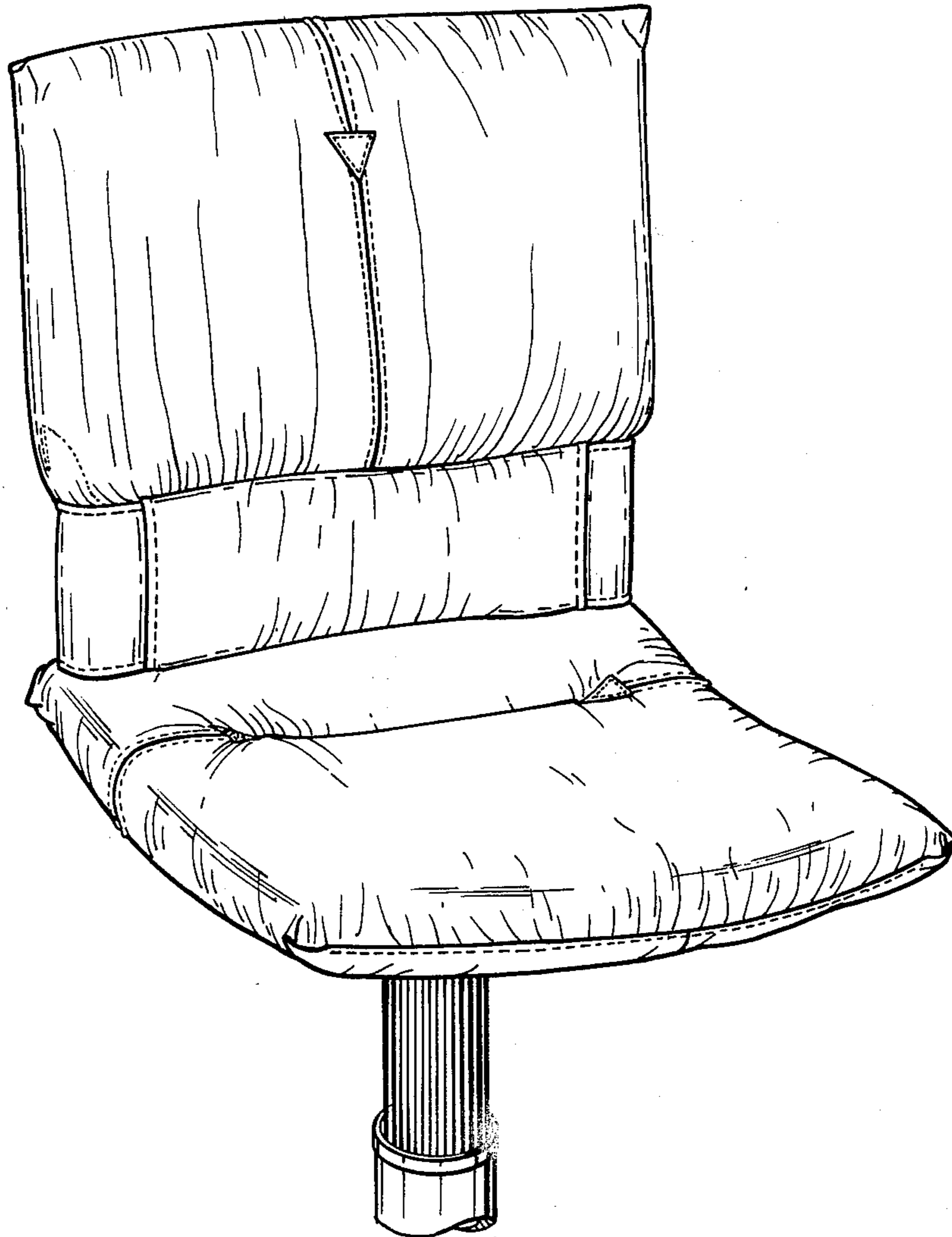

FIG. 7

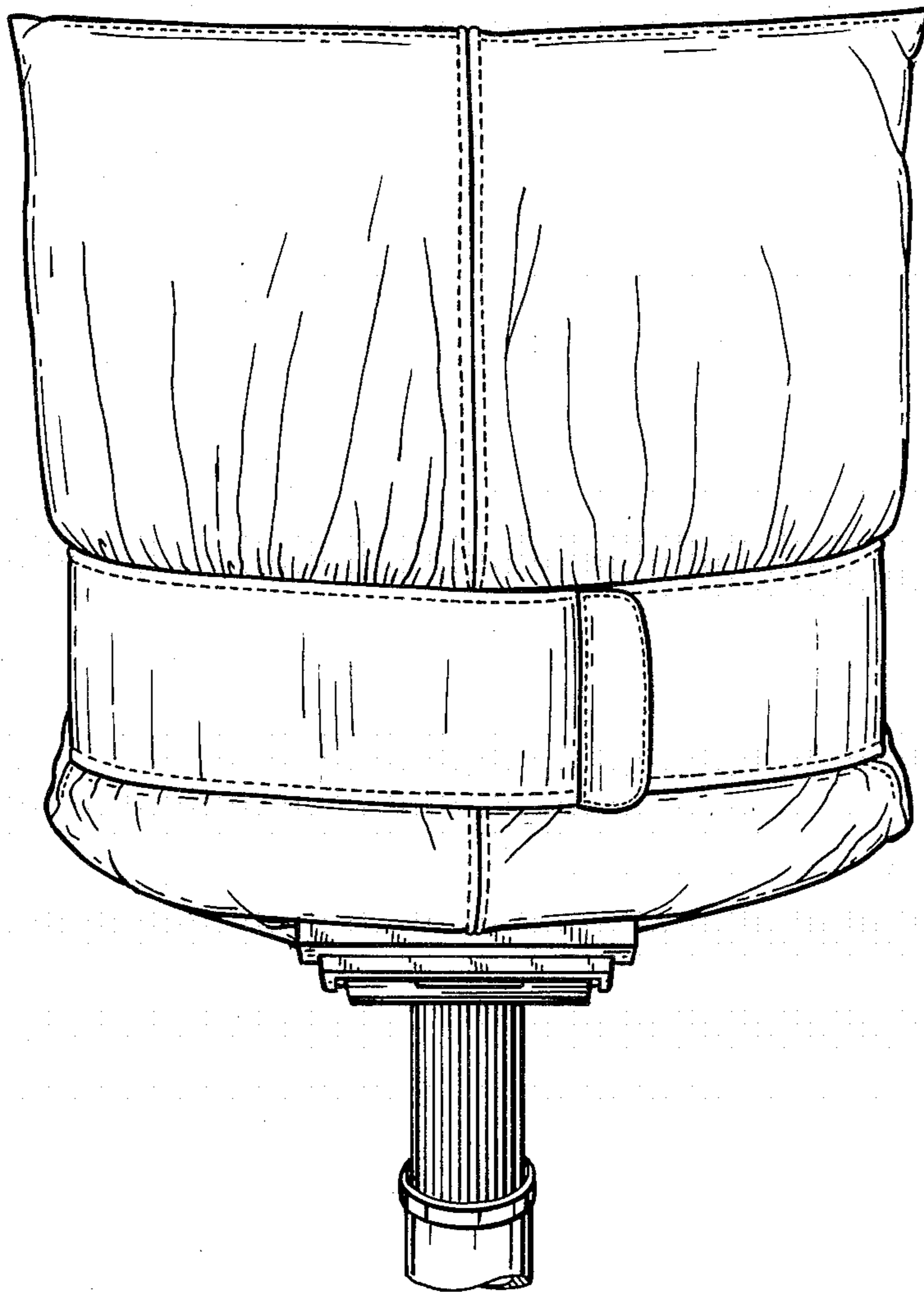

FIG. 8