

- [54] PROTECTIVE CAP FOR A CABLE CONNECTOR
- [75] Inventor: George Laurie, Fremont, Calif.
- [73] Assignee: Icore International, Inc., Sunnyvale, Calif.
- [**] Term: 14 Years
- [21] Appl. No.: 699,605
- [22] Filed: Feb. 8, 1985
- [52] U.S. Cl. D13/24
- [58] Field of Search D13/11-13, D13/20, 23-31, 99; 339/113 R, 36; 24/16 PB, 17 A, 17 AP; 248/74.5; 40/21 C; D8/396

- [56] **References Cited**
- U.S. PATENT DOCUMENTS**
- 3,672,003 6/1972 Morgan 24/16 PB
- 3,717,906 2/1973 Wells 24/16 PB
- FOREIGN PATENT DOCUMENTS**
- 3315073 11/1983 Fed. Rep. of Germany ... 24/16 PB
- 667640 9/1964 Italy 24/16 PB

2010027 6/1979 United Kingdom 339/36

OTHER PUBLICATIONS

Ideal Electrical and Machining Products Cat. by Ideal Industries, Jan. 12, 1960, "Crimp Connector".

Primary Examiner—Susan J. Lucas
Assistant Examiner—Clare E. Heflin
Attorney, Agent, or Firm—Townsend and Townsend

[57] **CLAIM**

The ornamental design for a protective cap for a cable connector, as shown and described.

DESCRIPTION

FIG. 1 is a front perspective view of the protective cap for a cable connector showing my new design; FIG. 2 is a side elevational view thereof; FIG. 3 is an end elevational view thereof; and FIG. 4 is a front perspective view of the protective cap for a cable connector showing an alternate embodiment of my new design; FIG. 5 is a rear perspective view of the first embodiment of my new design; and FIG. 6 is a rear perspective view of the second embodiment of my new design.

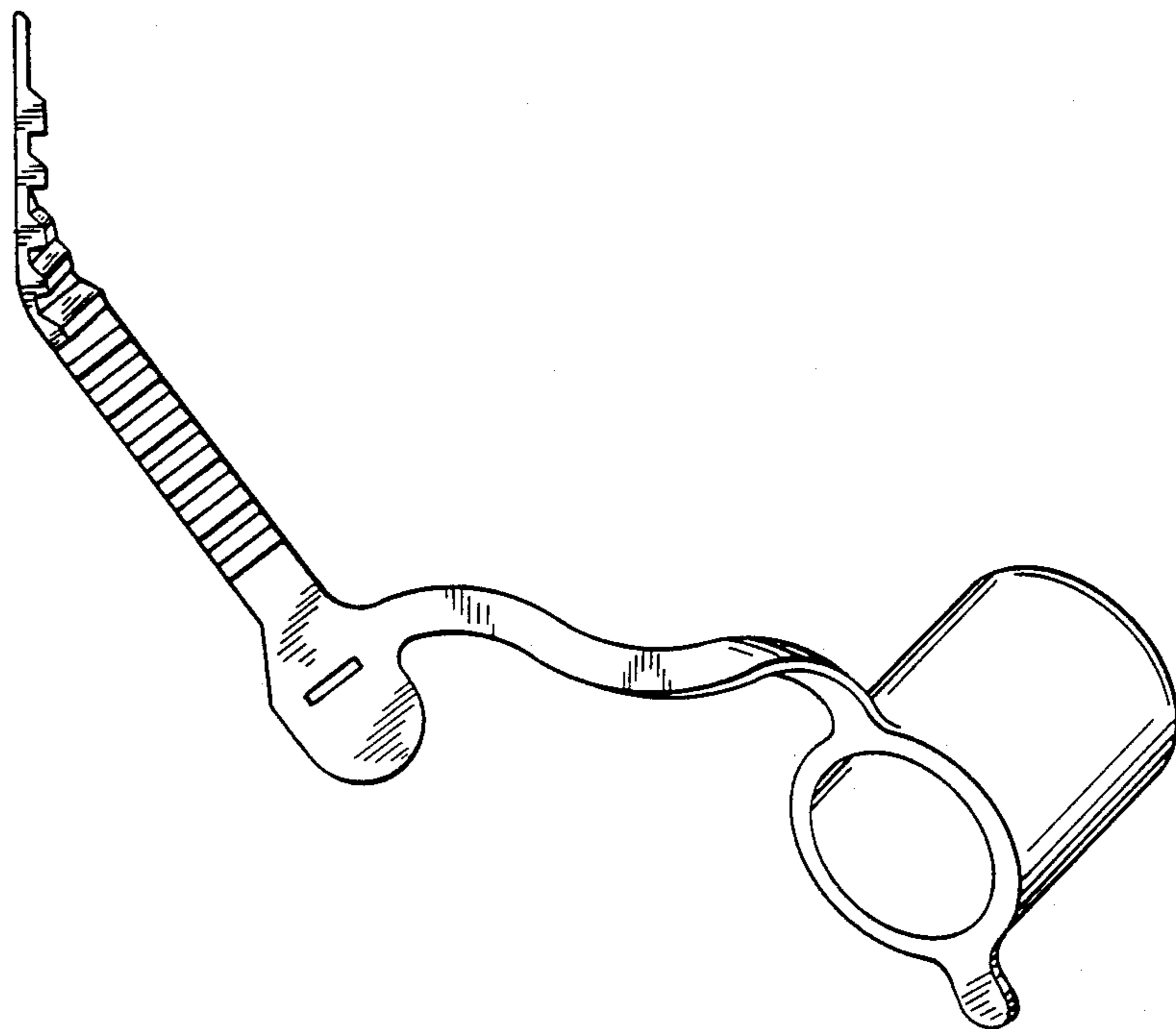

FIG. 1

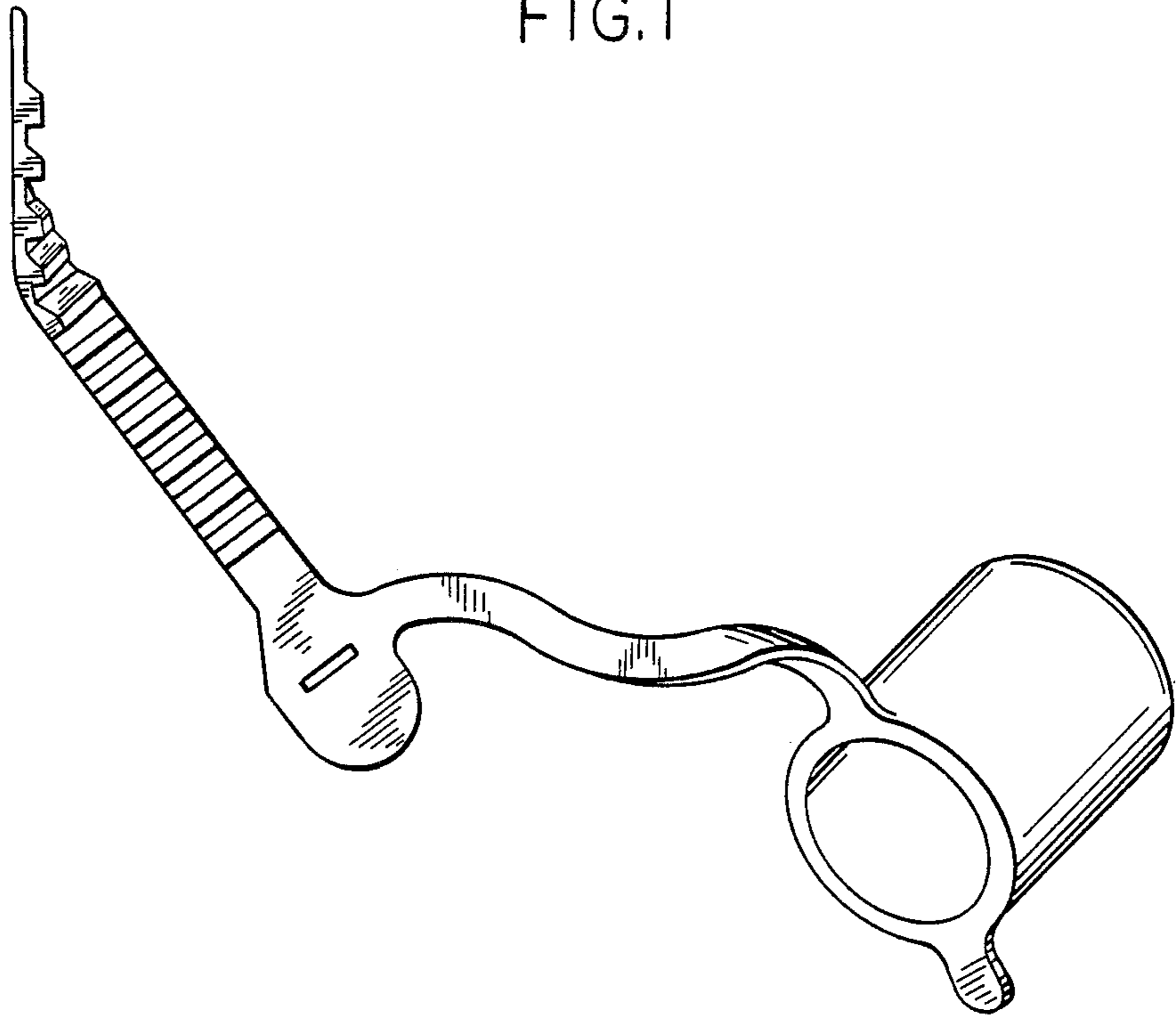

FIG. 2

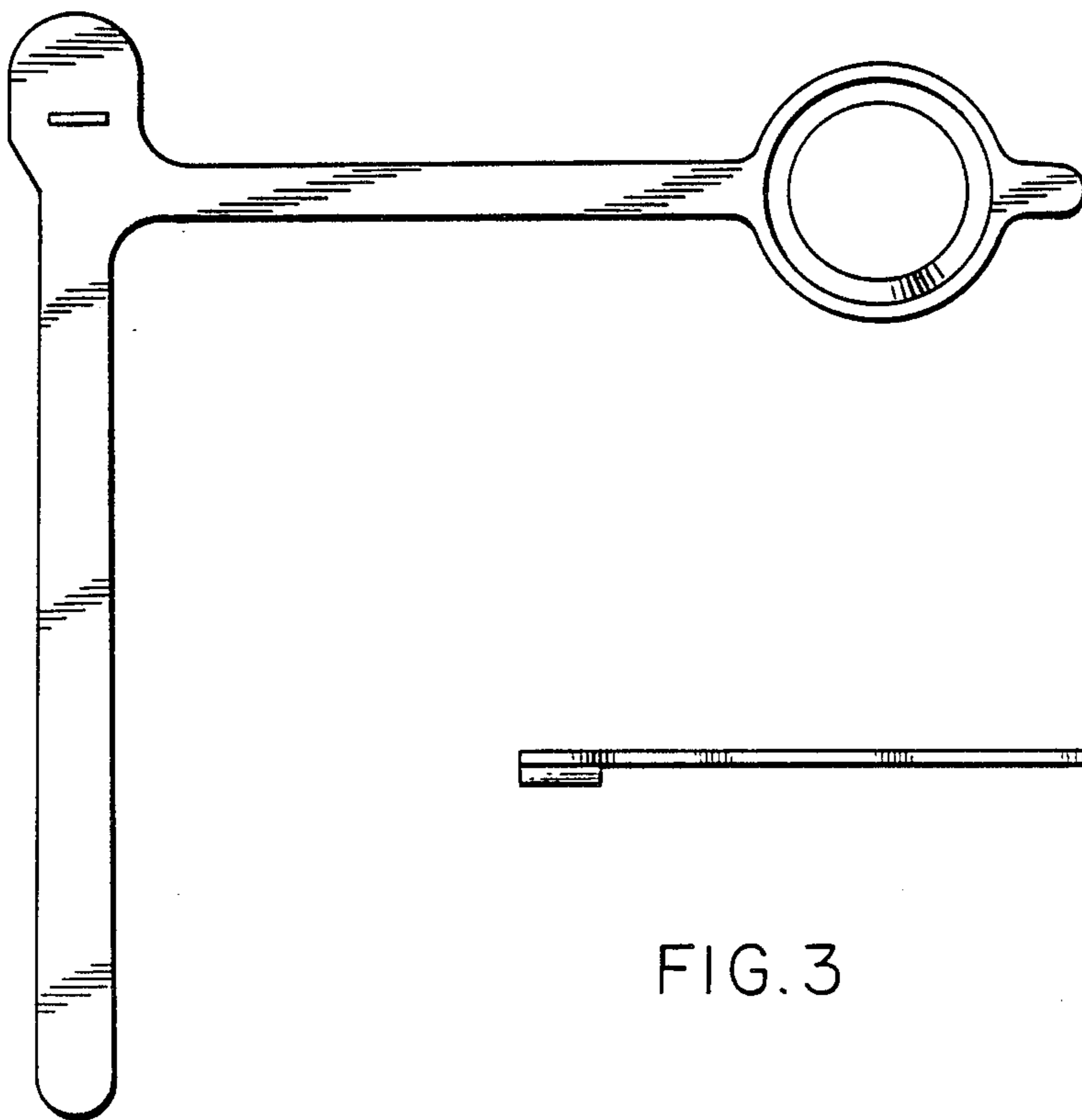

FIG. 3

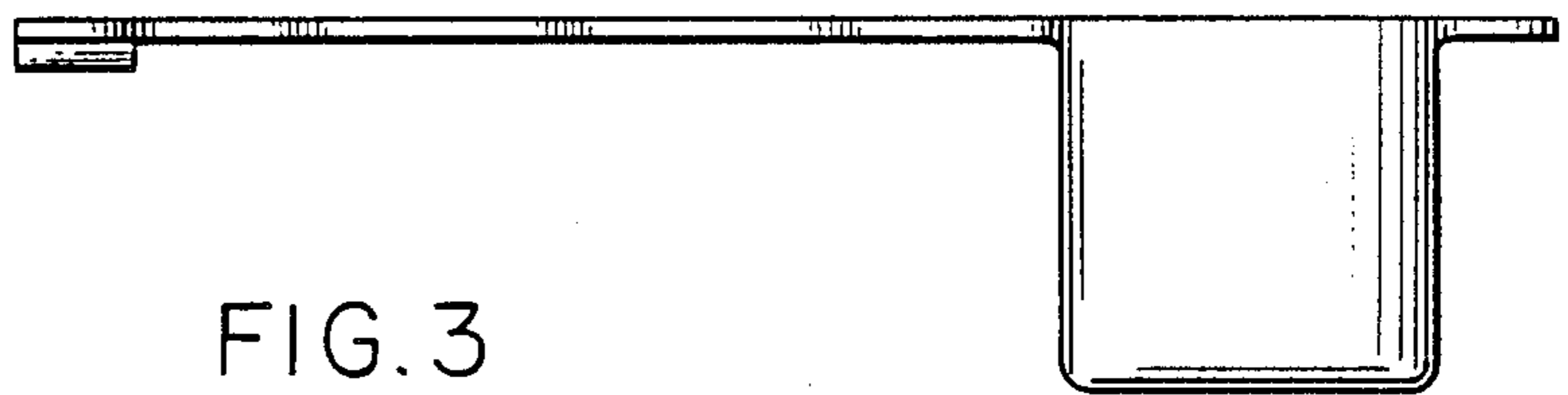
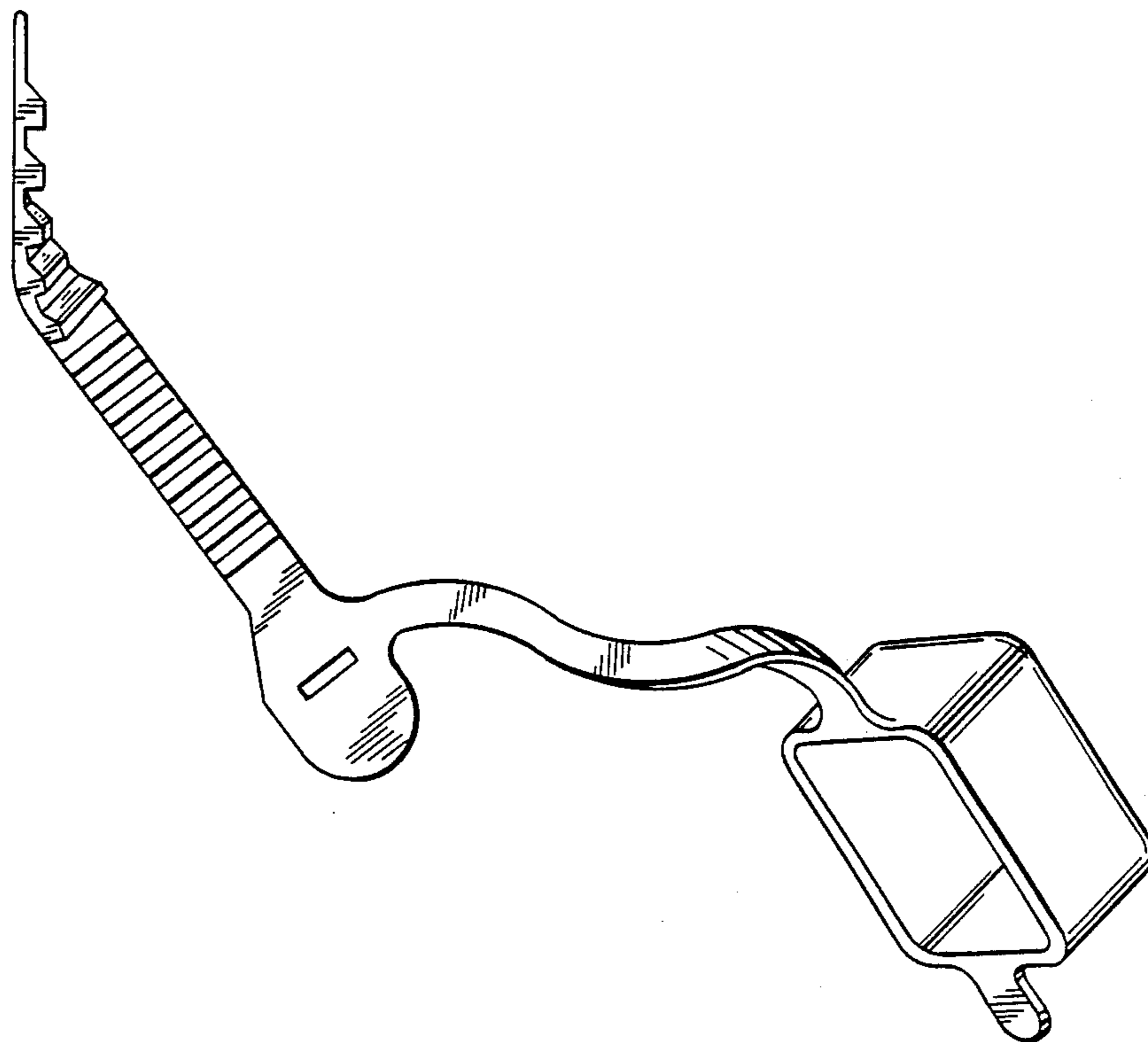

FIG. 4



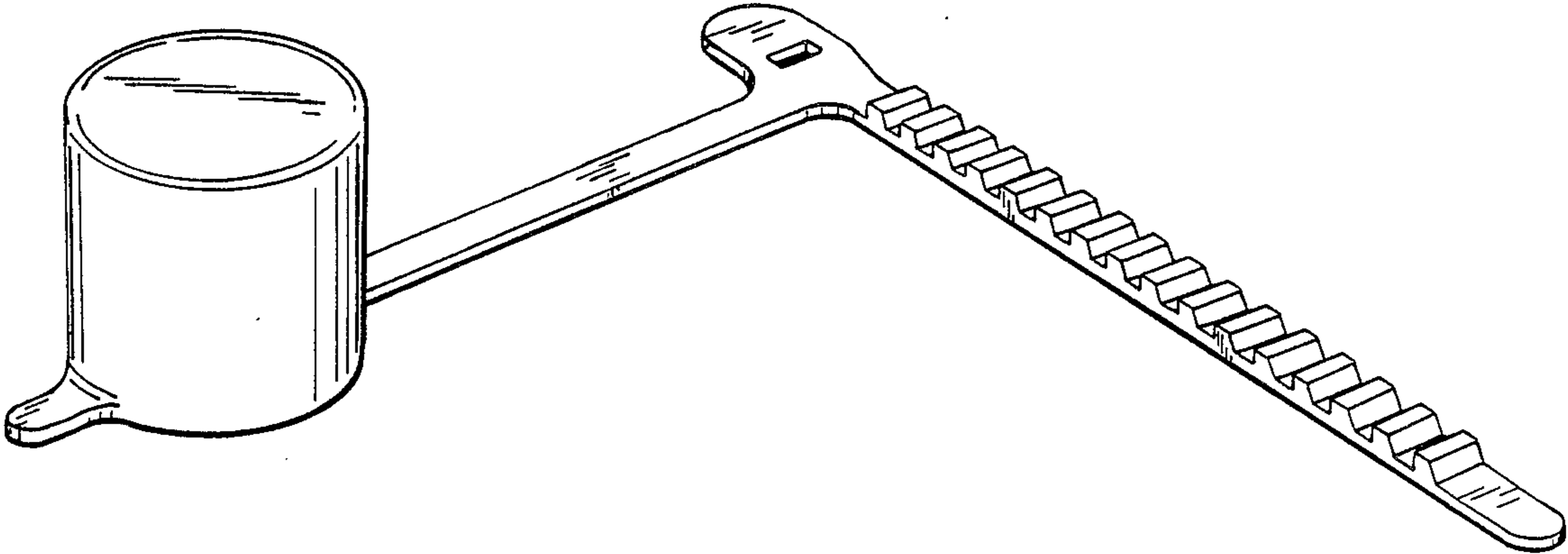

FIG. 5

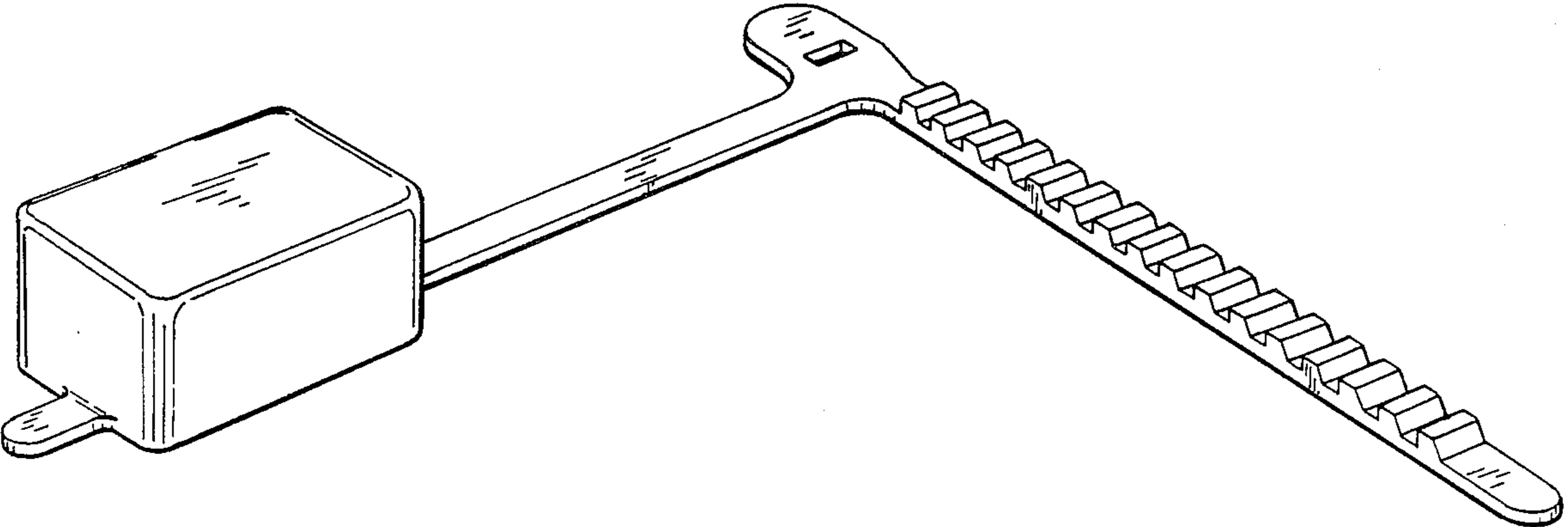

FIG. 6