

[54] FLASHLIGHT

[75] Inventors: David H. Powell, London; David E. Maddison, Pullborough; Richard W. Seymour, Surrey; Veronica G. Steel, London, all of England

[73] Assignee: Duracell Inc., Bethel, Conn.

[**] Term: 14 Years

[21] Appl. No.: 781,295

[22] Filed: Sep. 27, 1985

[30] Foreign Application Priority Data

Apr. 2, 1985 [GB] United Kingdom 1,025,932
[52] U.S. Cl. D26/46
[58] Field of Search D26/37-50;
362/157, 158, 183-208

[56]

References Cited

U.S. PATENT DOCUMENTS

3,196,268 7/1965 Mack 362/188
3,870,843 3/1975 Witte D26/46 X

FOREIGN PATENT DOCUMENTS

2413006 10/1975 Fed. Rep. of Germany 362/202

Primary Examiner—Susan J. Lucas

Attorney, Agent, or Firm—Ronald S. Cornell; James B. McVeigh

[57]

CLAIM

The ornamental design for a flashlight, substantially shown and described.

DESCRIPTION

FIG. 1 is a bottom plan view of a flashlight embodying our new design;
FIG. 2 is a top plan view thereof
FIG. 3 is a right side elevation view thereof, the left side being a mirror image;
FIG. 4 is a top, front isometric view thereof;
FIG. 5 is a rear end elevational view thereof; and
FIG. 6 is a front end elevational view thereof.

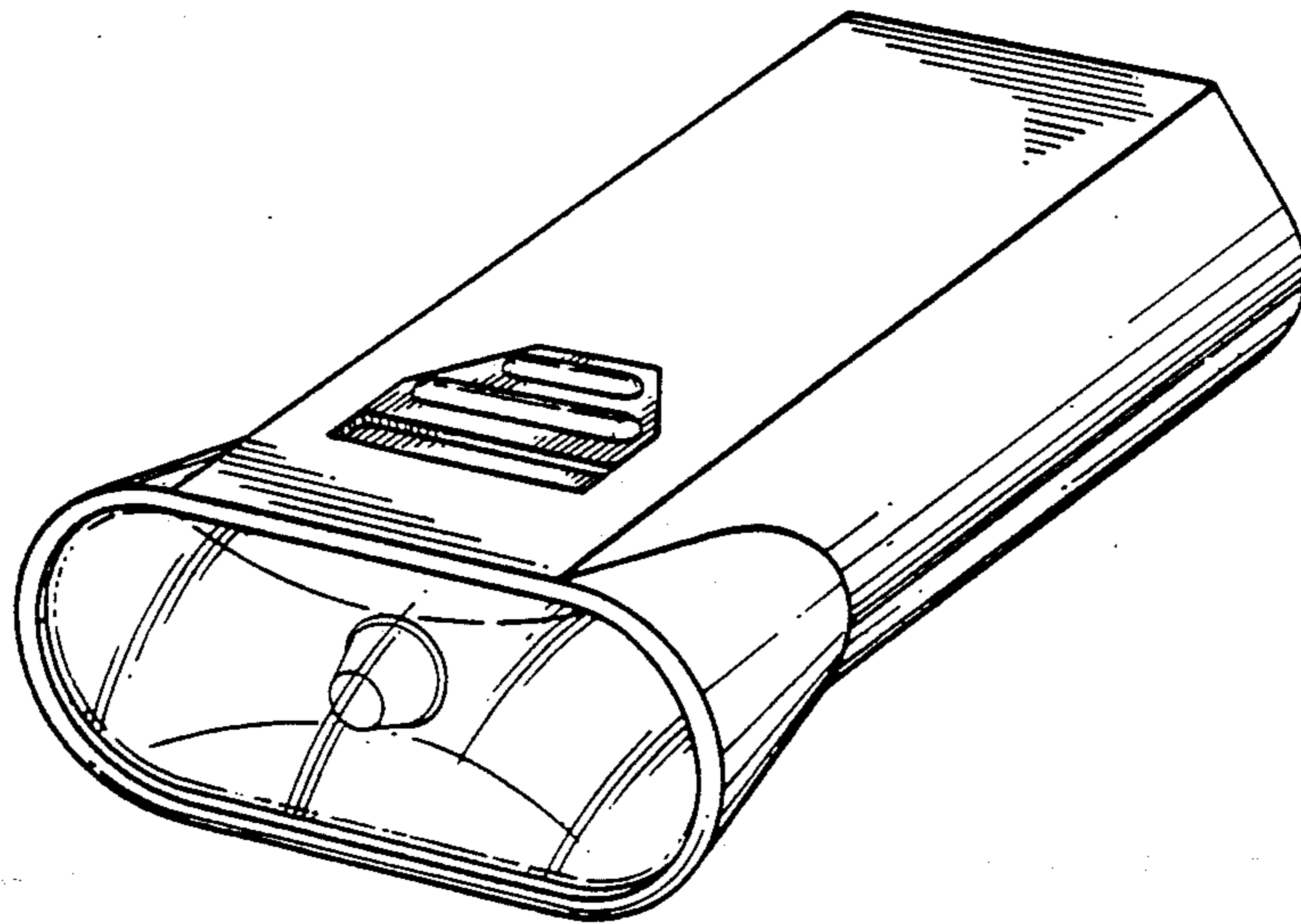

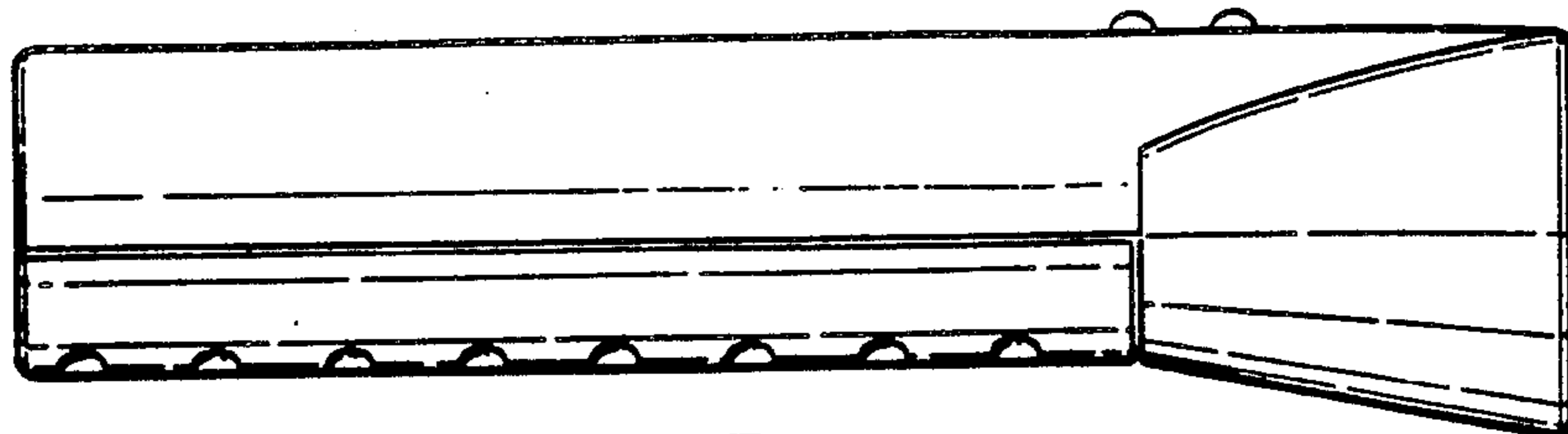

FIG. 3

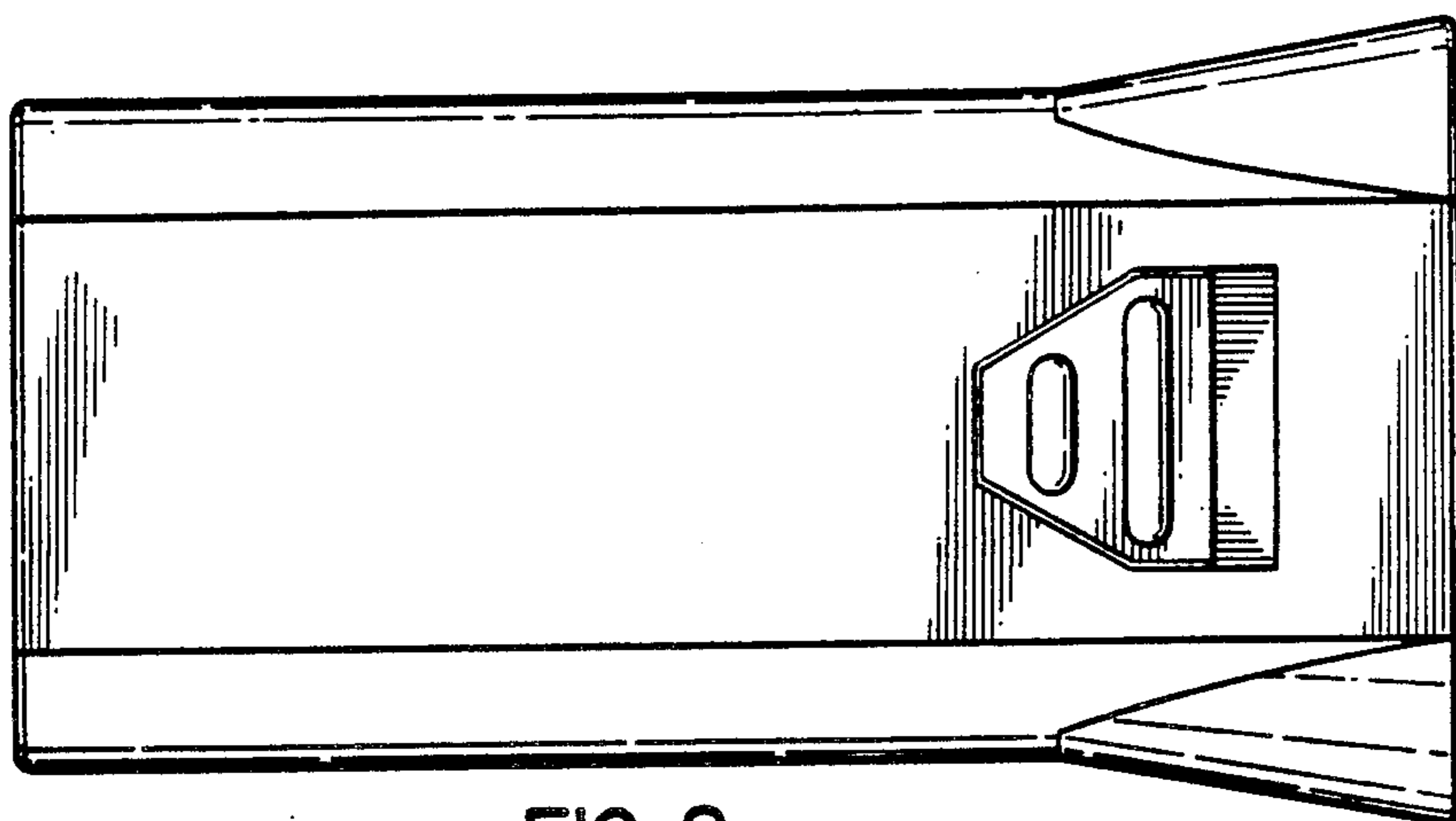

FIG. 2

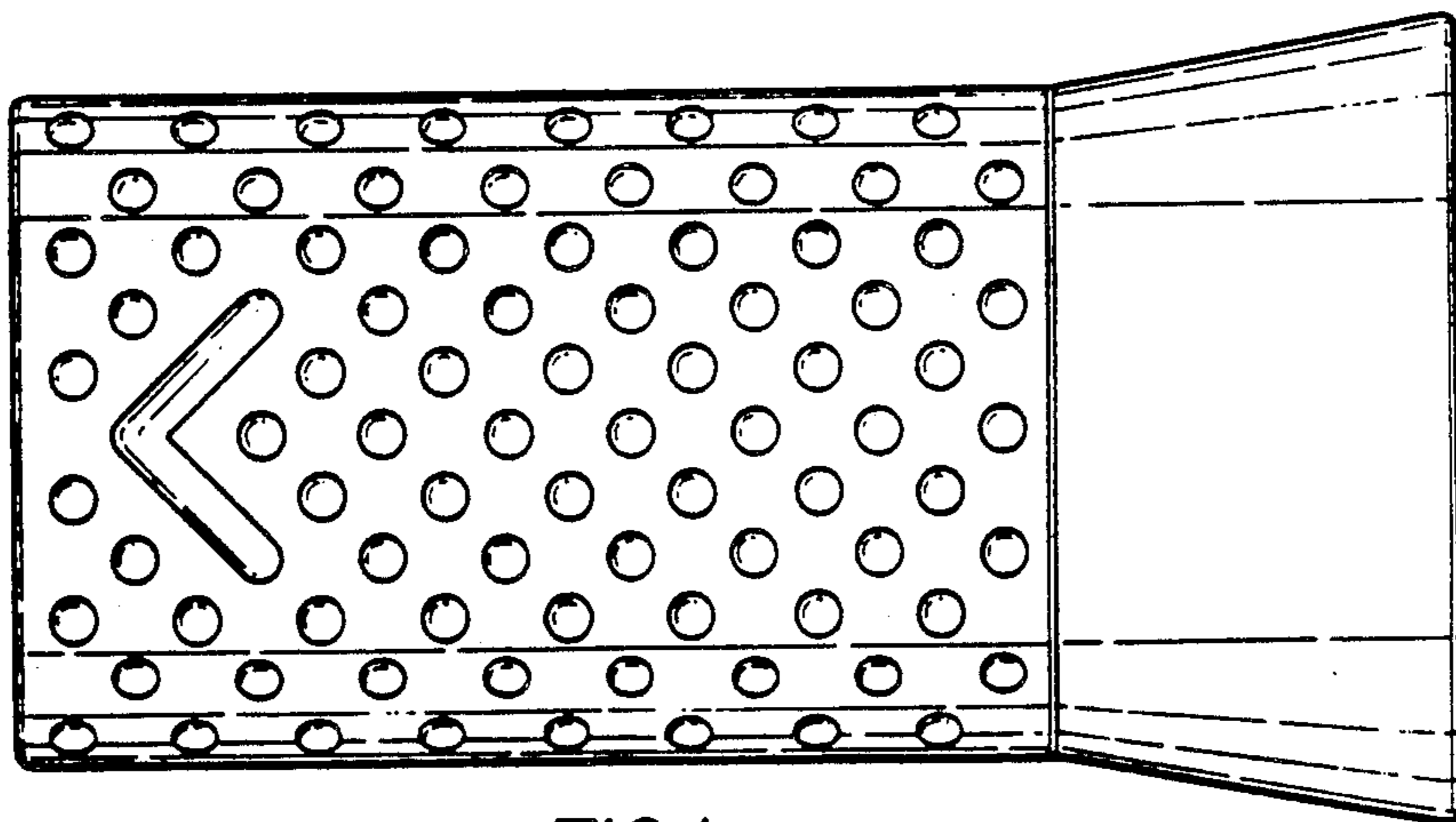

FIG. 1

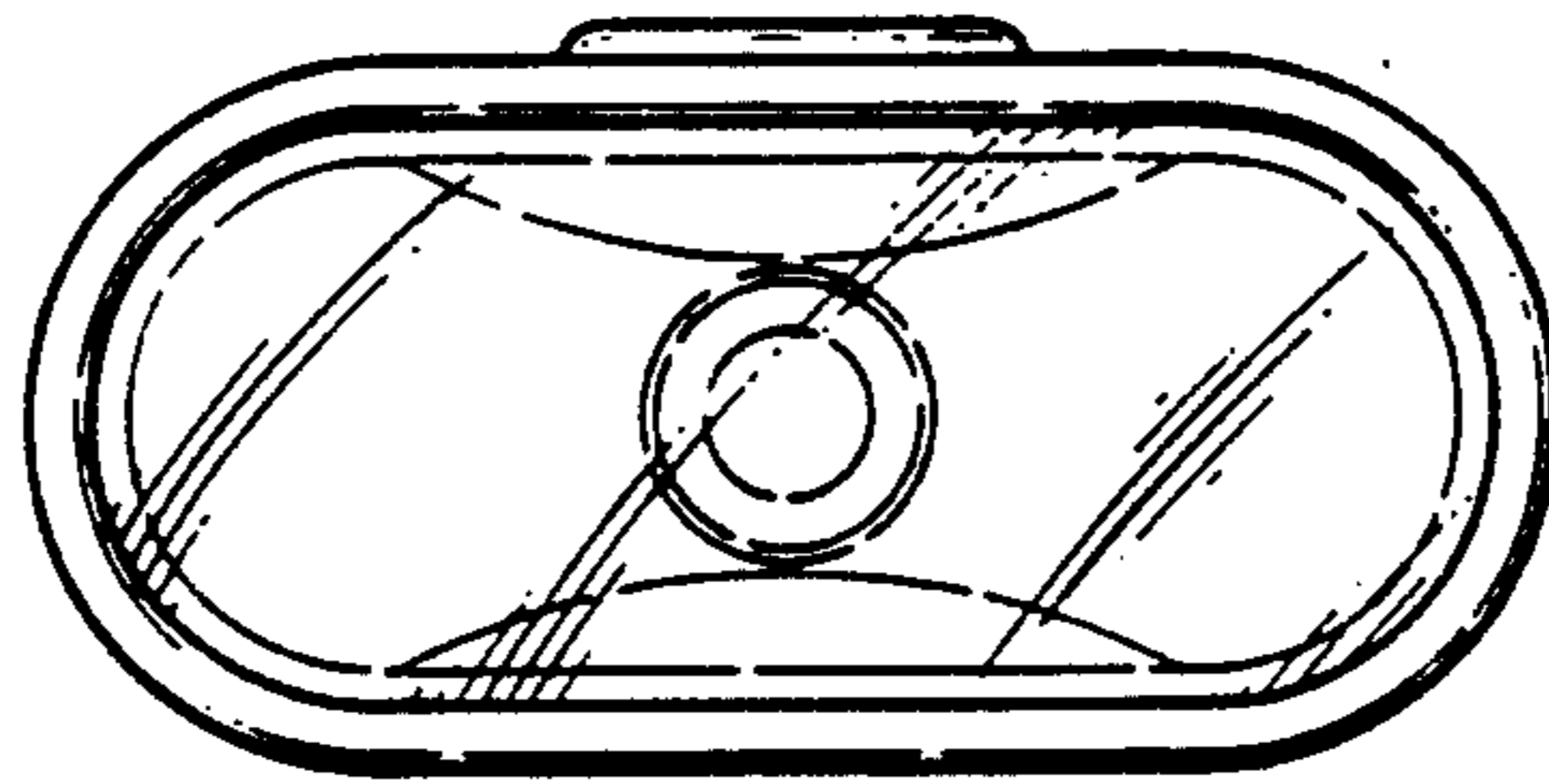

FIG. 6

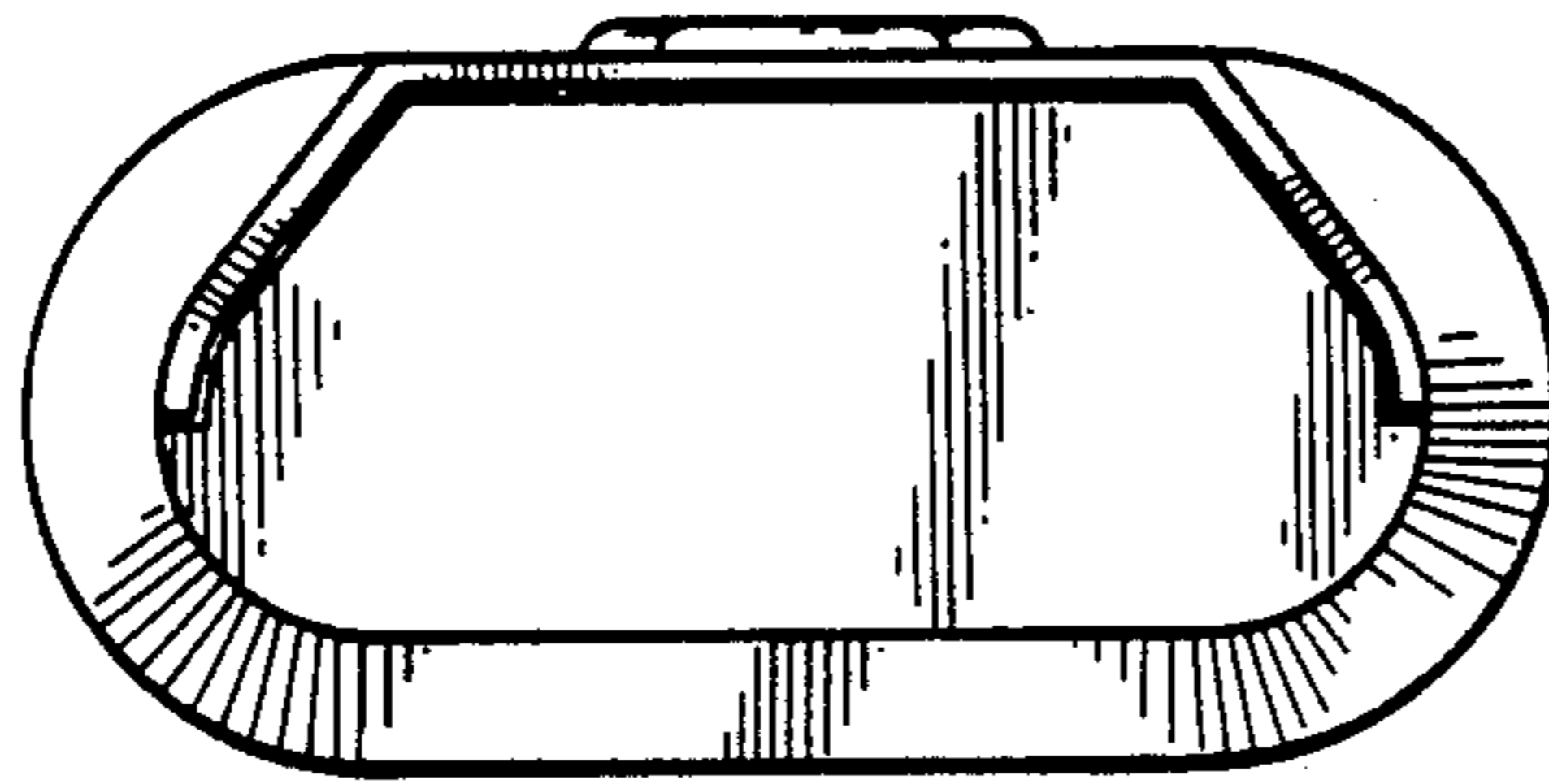

FIG. 5

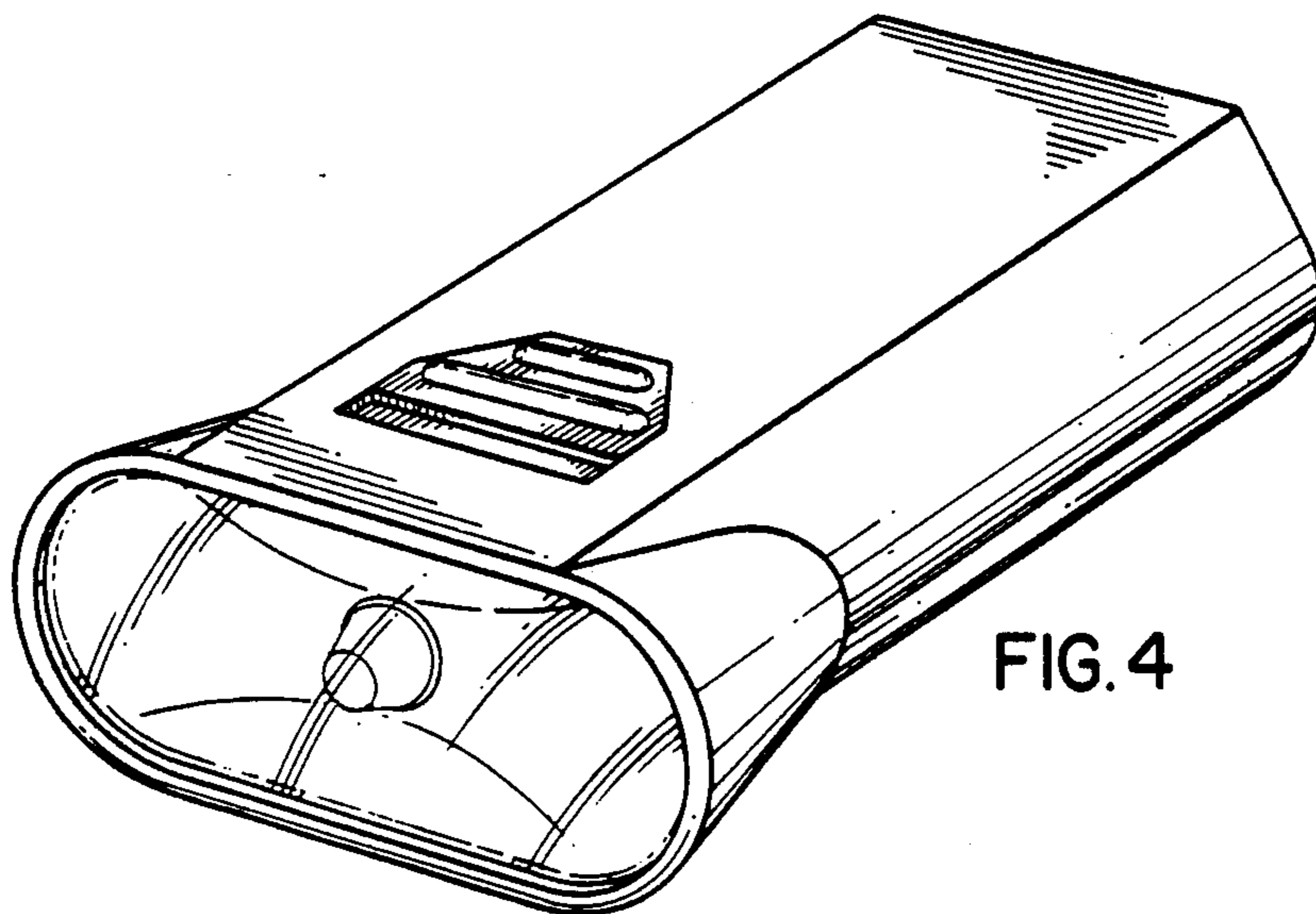

FIG. 4