

[54] TELEPHONE SET
 [75] Inventors: Joseph G. Aschauer, Newtown; John Cuccio, Westport, both of Conn.
 [73] Assignee: TIE/communications, Inc., Shelton, Conn.
 [**] Term: 14 Years
 [21] Appl. No.: 701,783
 [22] Filed: Feb. 14, 1985
 [52] U.S. Cl. D14/58; D14/53; D14/57
 [58] Field of Search D14/52, 53, 58, 57, D14/62, 60, 63; 179/100 R, 100 D, 100 C, 100 L, 101, 102

D. 283,508 4/1986 Miyake D14/58 X
 D. 284,573 7/1986 Ando D14/58
 D. 284,855 7/1986 Graf D14/53
 D. 287,585 1/1987 Brown et al. D14/62
 4,515,998 5/1985 Pinede et al. 179/146 R

Primary Examiner—Wallace R. Burke
 Assistant Examiner—Horace B. Fay
 Attorney, Agent, or Firm—Francis N. Carten

[56] **References Cited**
 U.S. PATENT DOCUMENTS

D. 267,091 11/1982 Ohno D14/58
 D. 275,008 8/1984 Martin D14/53
 D. 280,324 8/1985 Endt D14/53

[57] **CLAIM**
 The ornamental design for a telephone set, substantially as shown and described.

DESCRIPTION
 FIG. 1 is a top and right side isometric view of a telephone set showing our new design;
 FIG. 2 is a top plan view thereof;
 FIG. 3 is a front elevational view thereof;
 FIG. 4 is a bottom plan view thereof;
 FIG. 5 is a rear elevational view thereof; and,
 FIGS. 6 and 7 are respectively right and left side elevational views thereof.

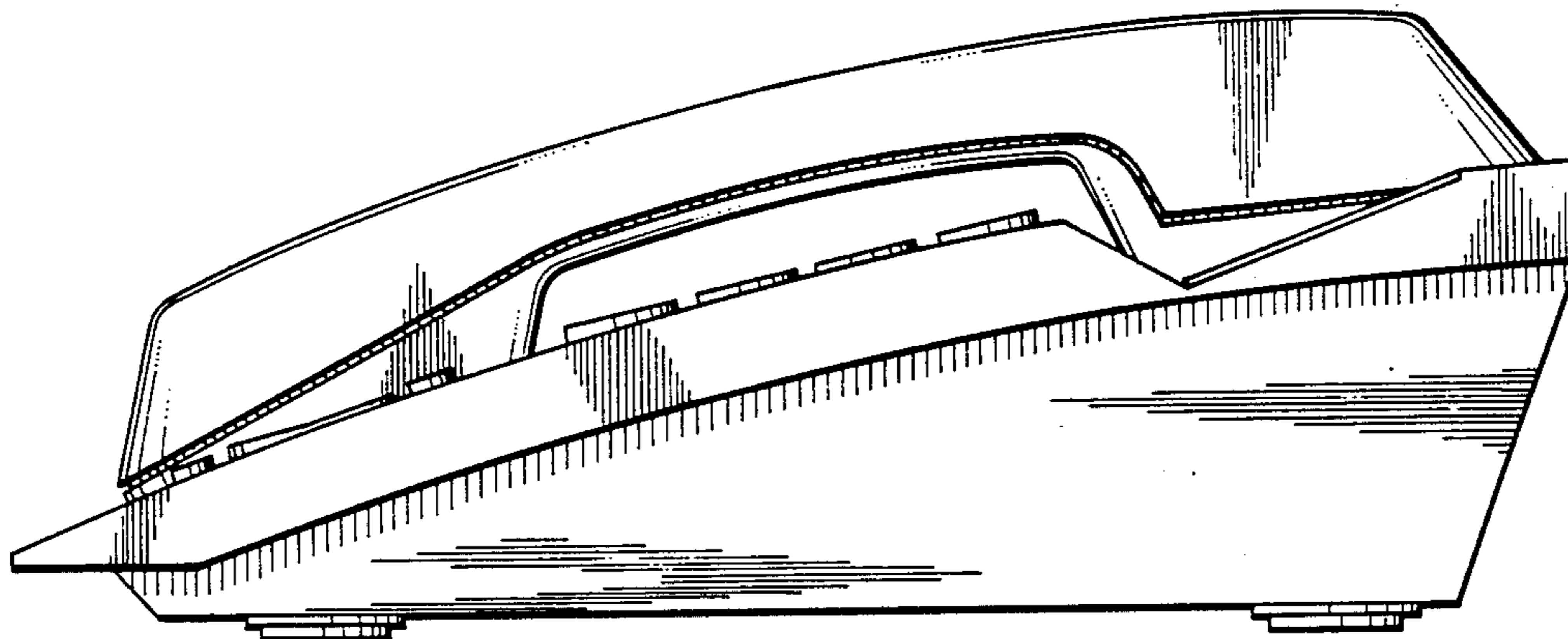

FIG. 1.

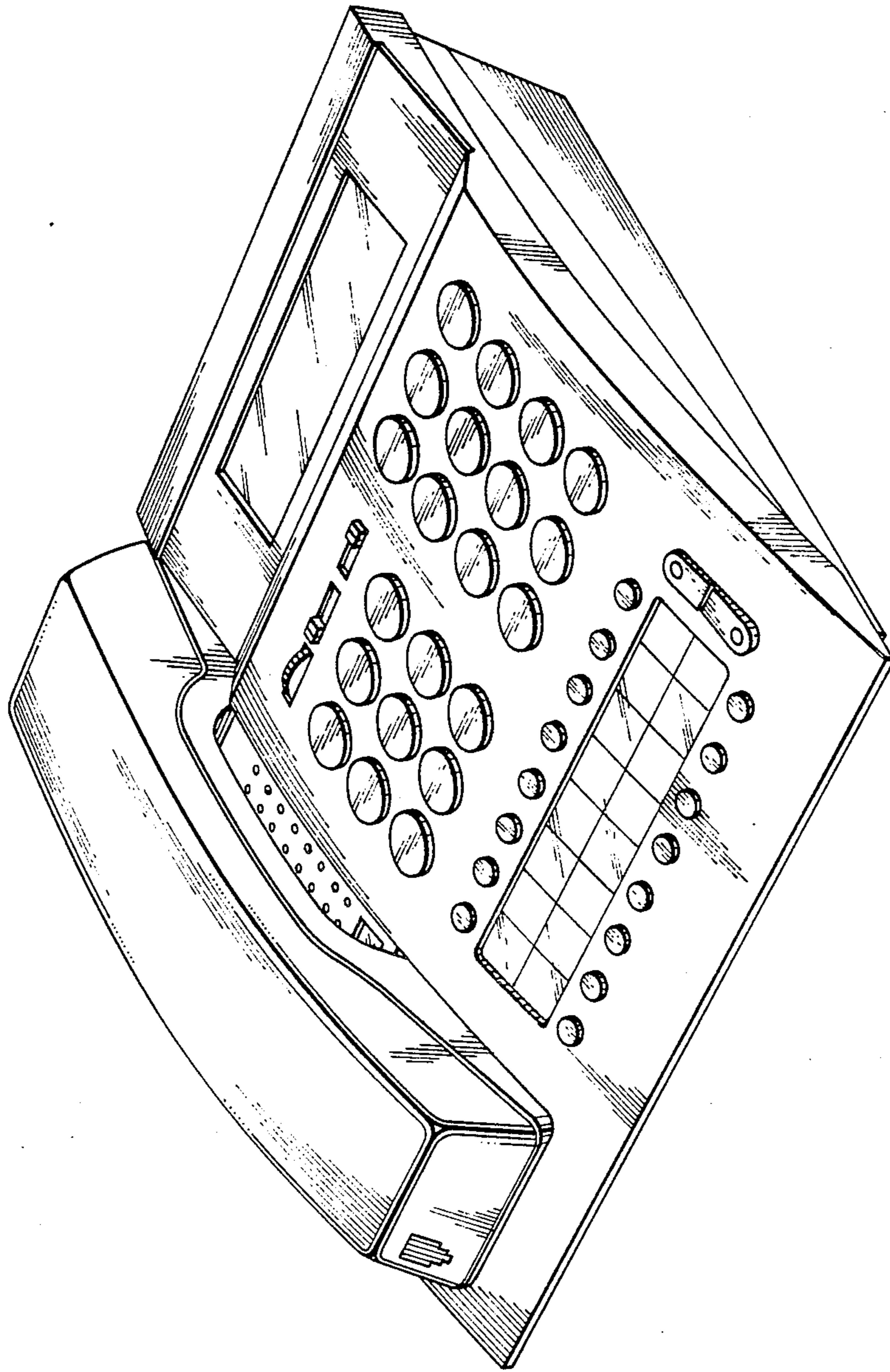

FIG. 2.

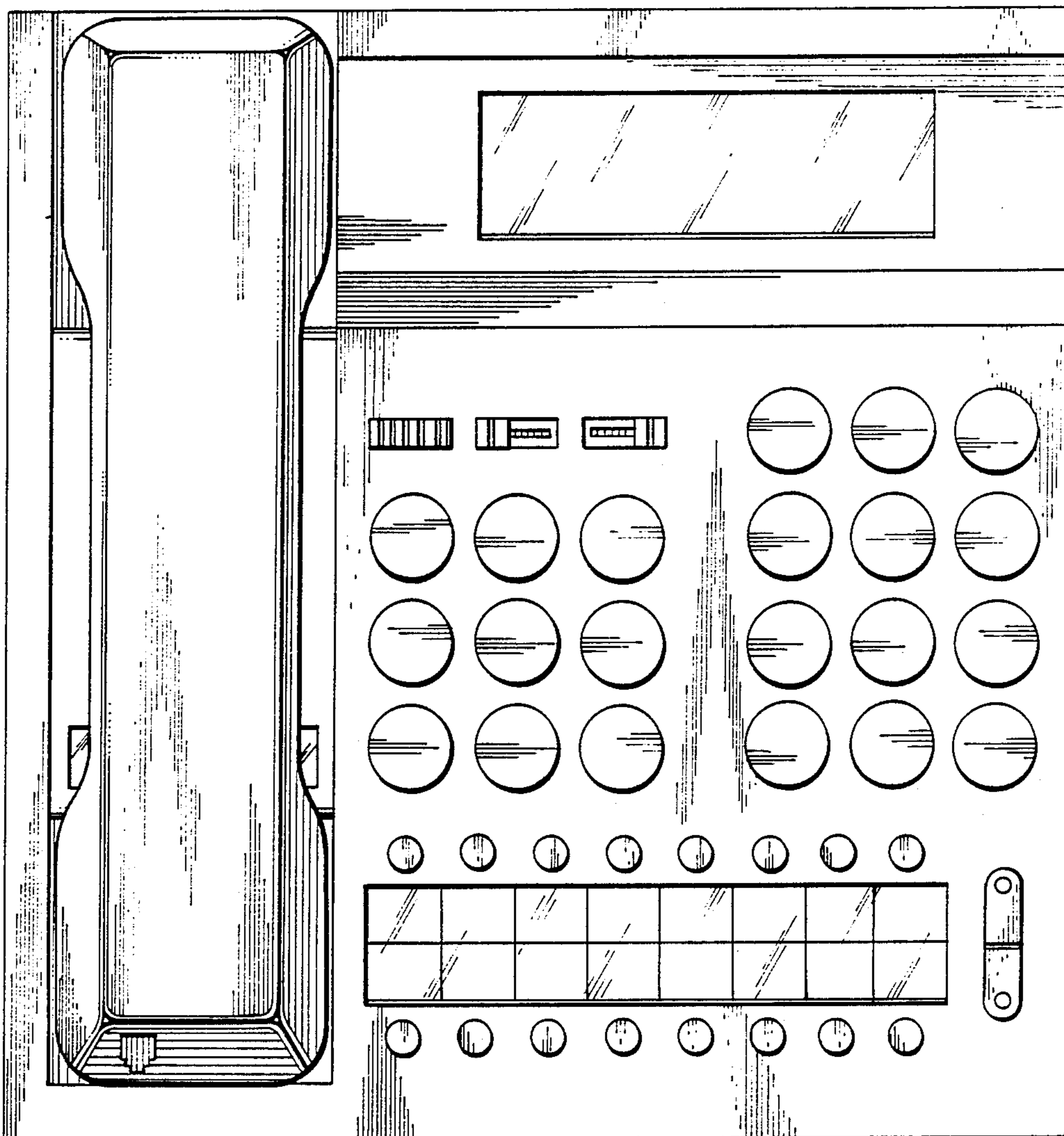

FIG. 3.

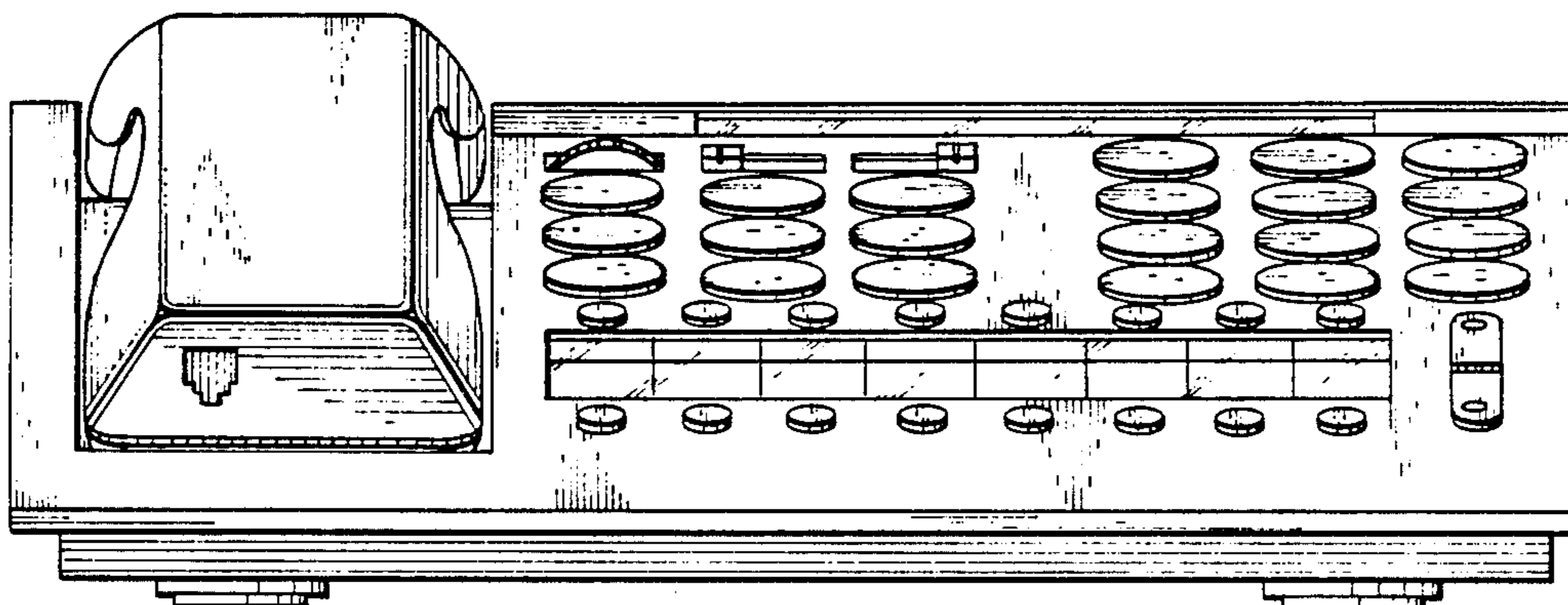

FIG. 4.

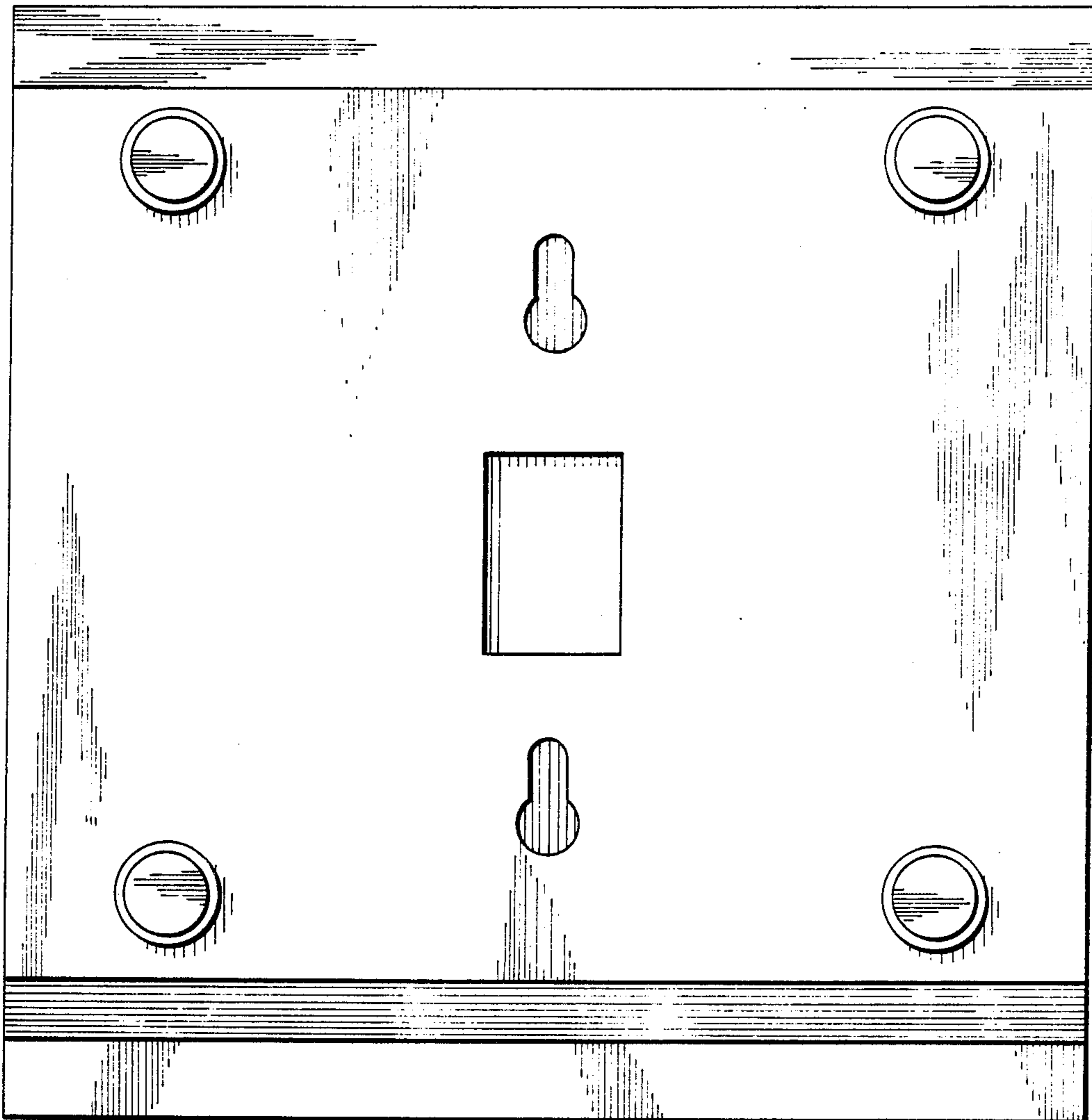

FIG. 5.

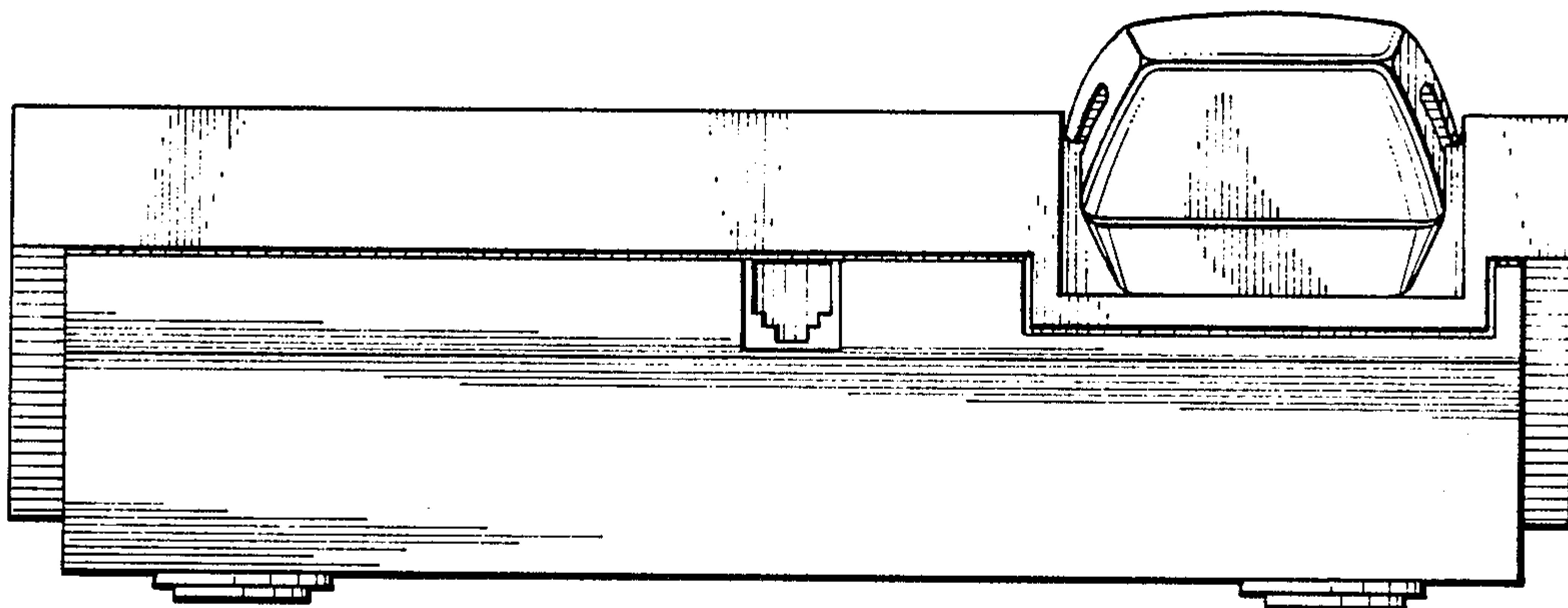

FIG. 6.

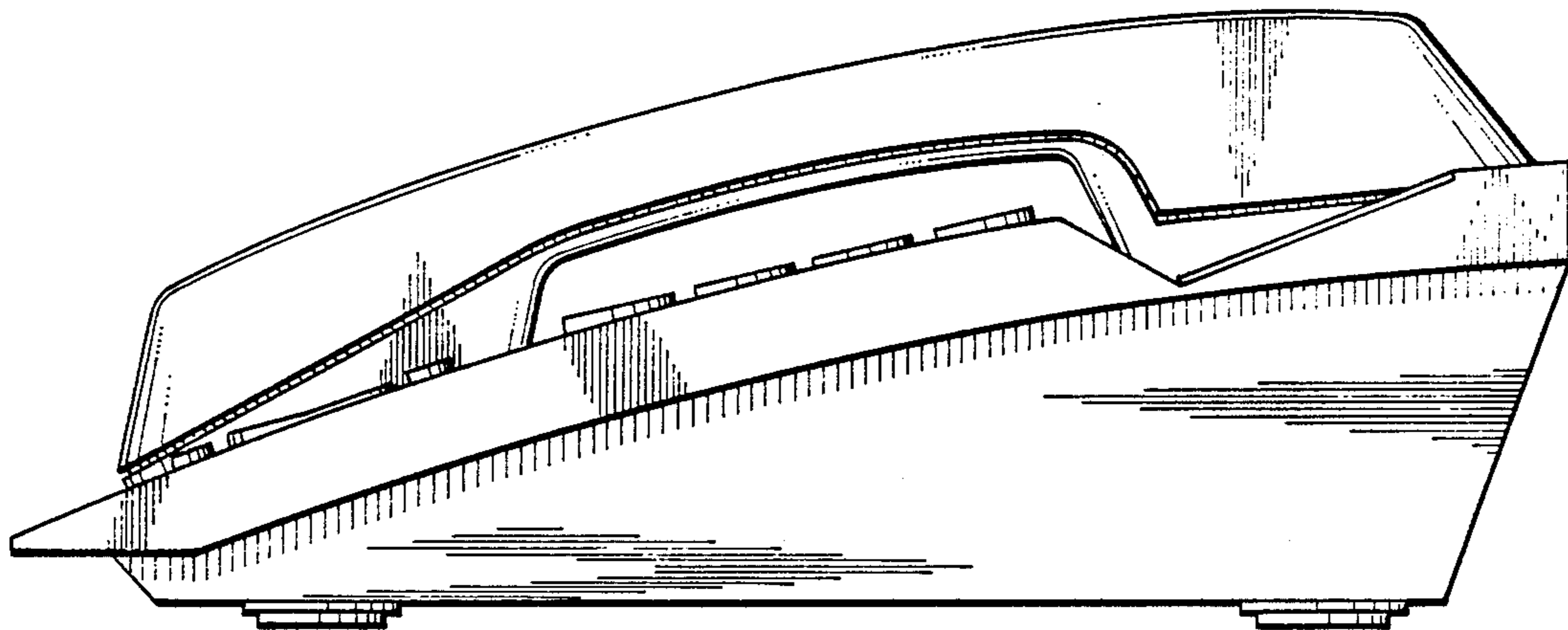

FIG. 7.

