

[54] OIL HEATER

[75] Inventors: Shuzo Sawa; Matafumi Ikeda, both of Osaka, Japan

[73] Assignee: Sharp Corporation, Osaka, Japan

[\*\*] Term: 14 Years

[21] Appl. No.: 774,782

[22] Filed: Sep. 11, 1985

[30] Foreign Application Priority Data

Mar. 23, 1985 [JP] Japan ..... 60-11530

[52] U.S. Cl. .... D23/338

[58] Field of Search ..... D23/92, 93, 119-124; 126/92-97

[56] References Cited

U.S. PATENT DOCUMENTS

D. 176,390 12/1955 Theisen ..... D23/121

D. 269,541 6/1983 Nakamura ..... D23/123

|            |         |                |       |         |
|------------|---------|----------------|-------|---------|
| D. 275,880 | 10/1984 | Nakamura       | ..... | D23/121 |
| D. 276,546 | 11/1984 | Okamoto et al. | ..... | D23/121 |
| D. 282,773 | 2/1986  | Mase et al.    | ..... | D23/121 |
| D. 284,503 | 7/1986  | Nakamura       | ..... | D23/121 |

Primary Examiner—Catherine E. Kemper  
Attorney, Agent, or Firm—Flehr, Hohbach, Test,  
Albritton & Herbert

[57] CLAIM

The ornamental design for an oil heater, as shown and described.

DESCRIPTION

FIG. 1 is a perspective view of the oil heater showing our new design;  
FIG. 2 is a front elevational view thereof;  
FIG. 3 is a rear elevational view thereof;  
FIG. 4 is a right side elevational view, the left side elevational view being a mirror image thereof;  
FIG. 5 is a top plan view thereof; and  
FIG. 6 is a bottom plan view thereof.

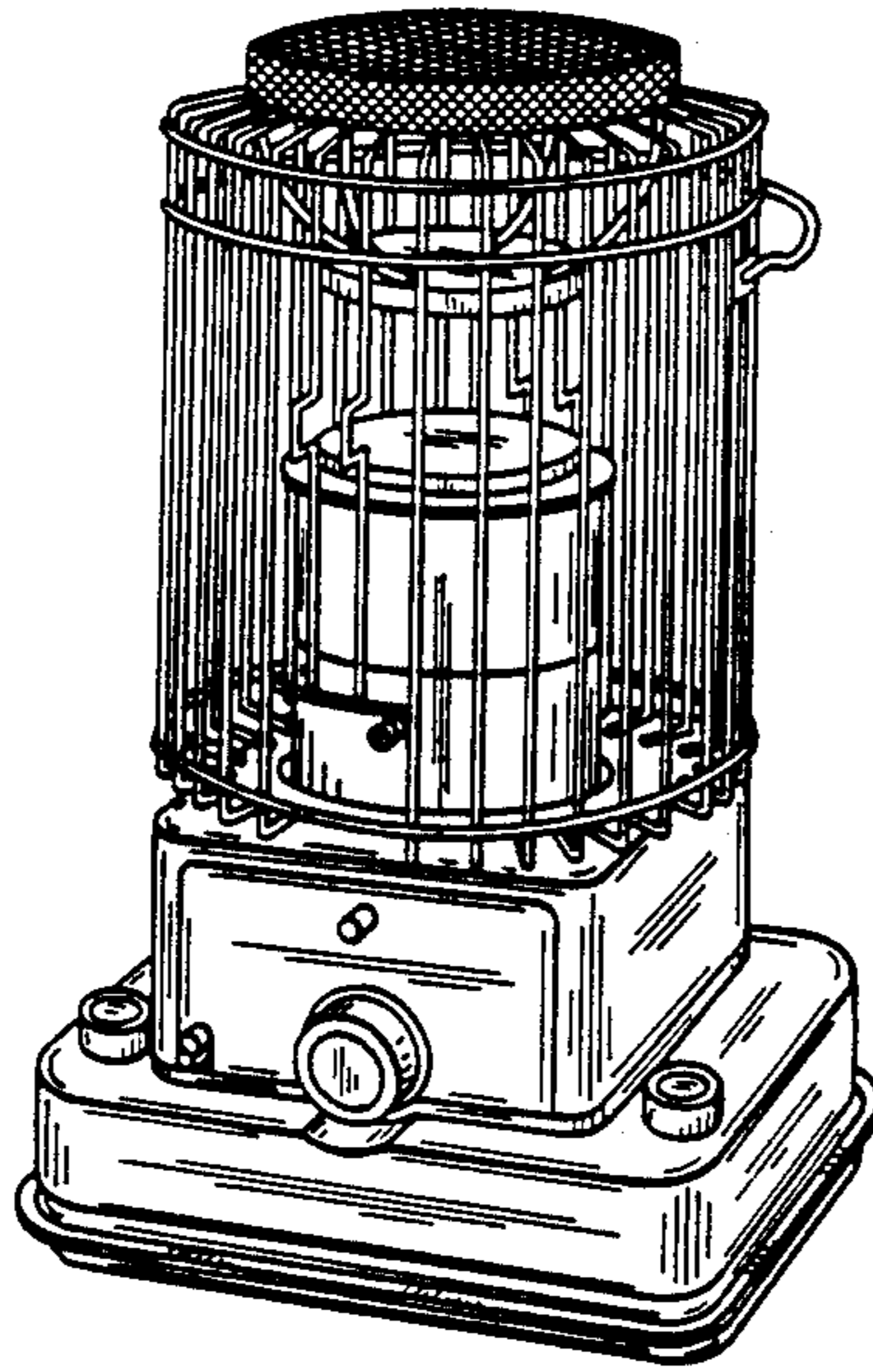

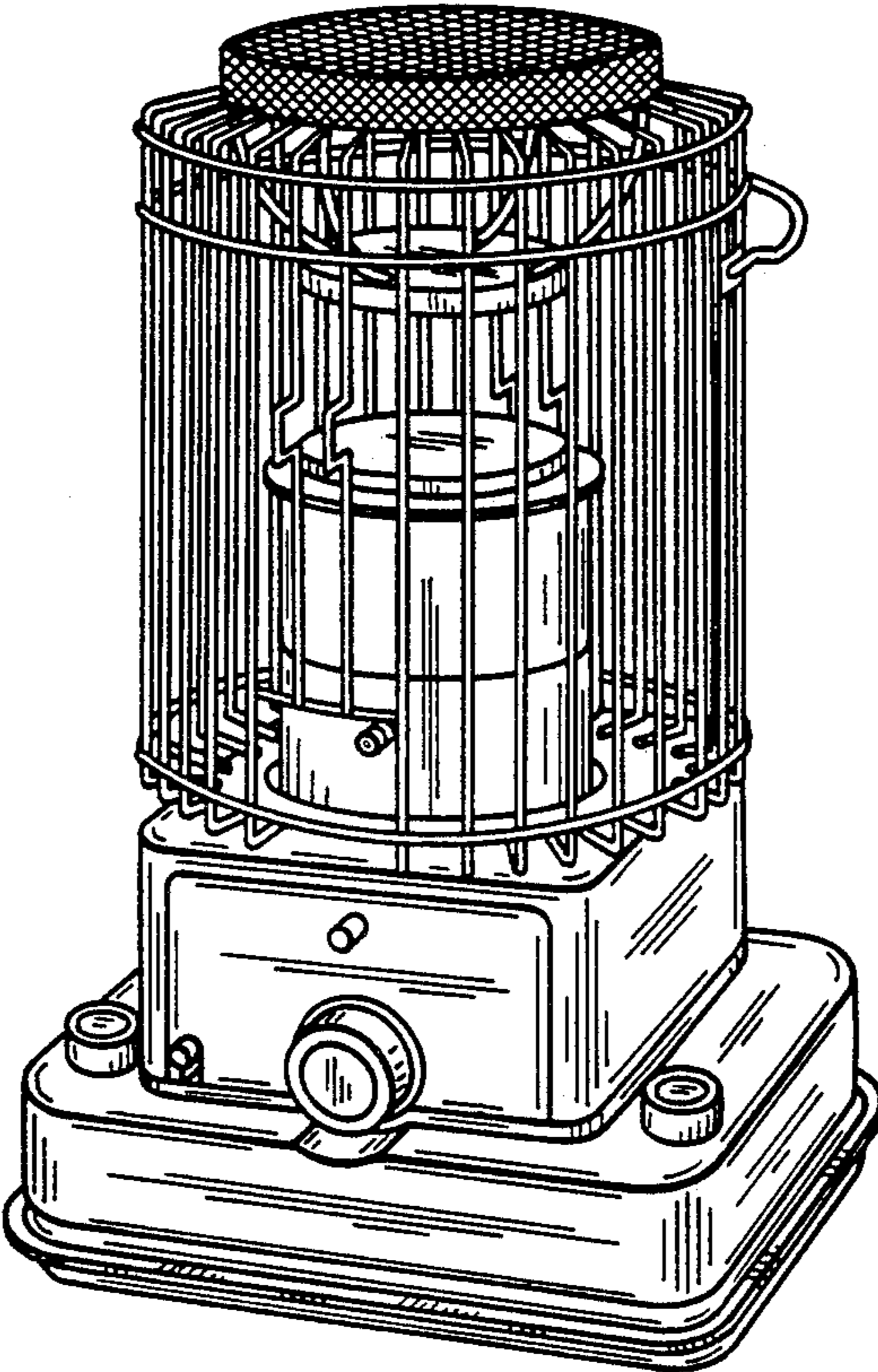

*FIG\_1*

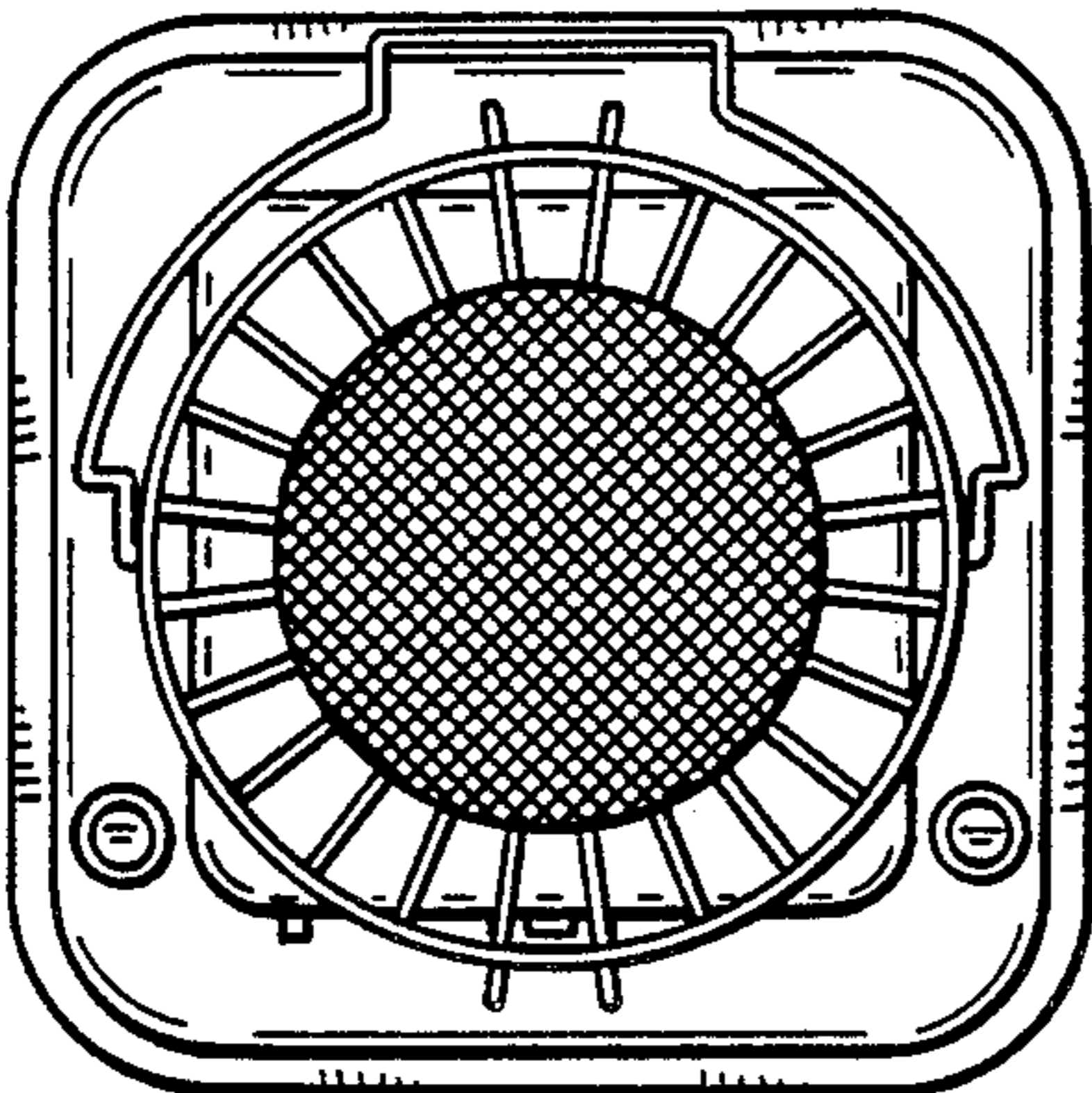

*FIG\_5*

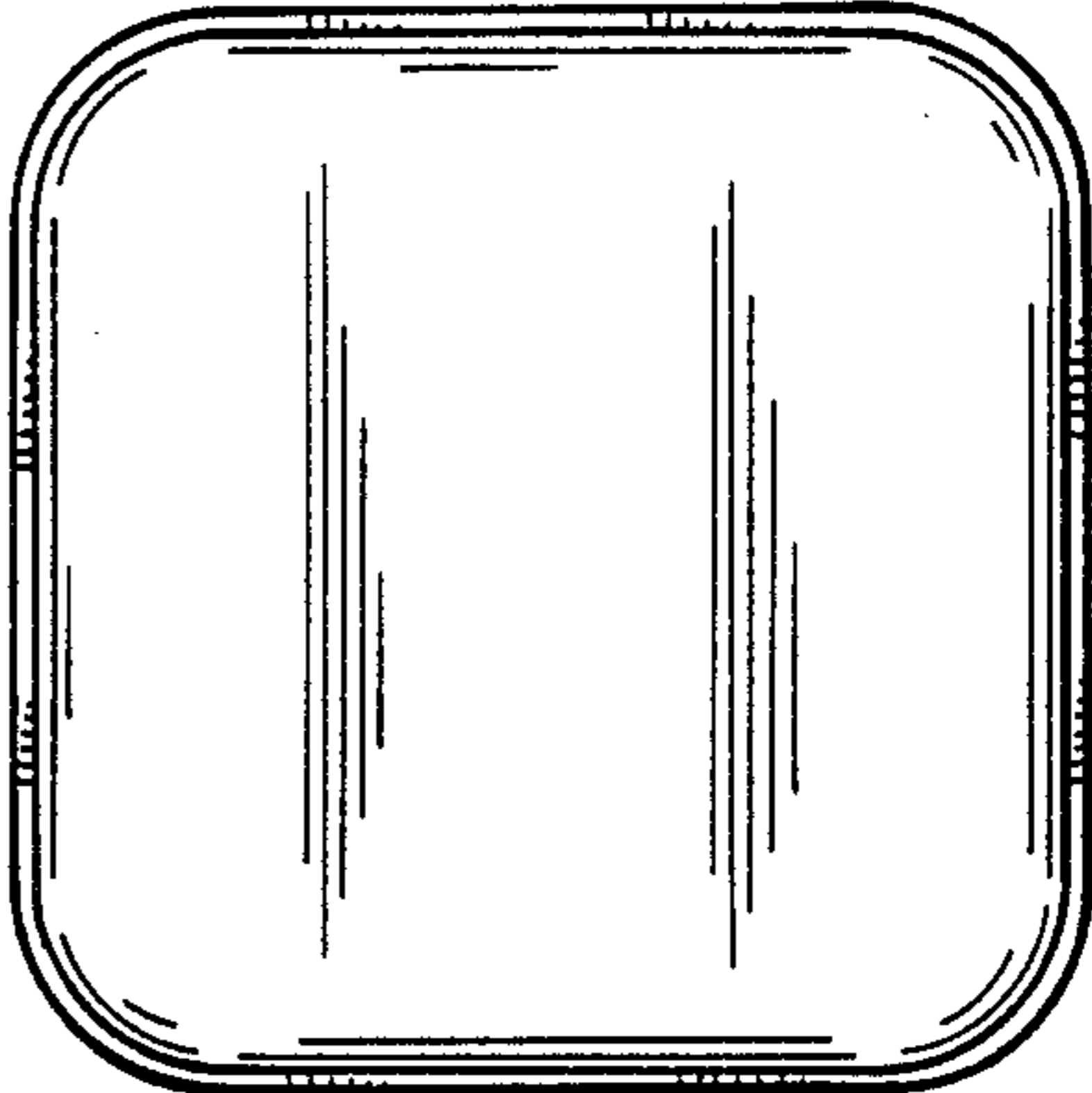

*FIG\_6*

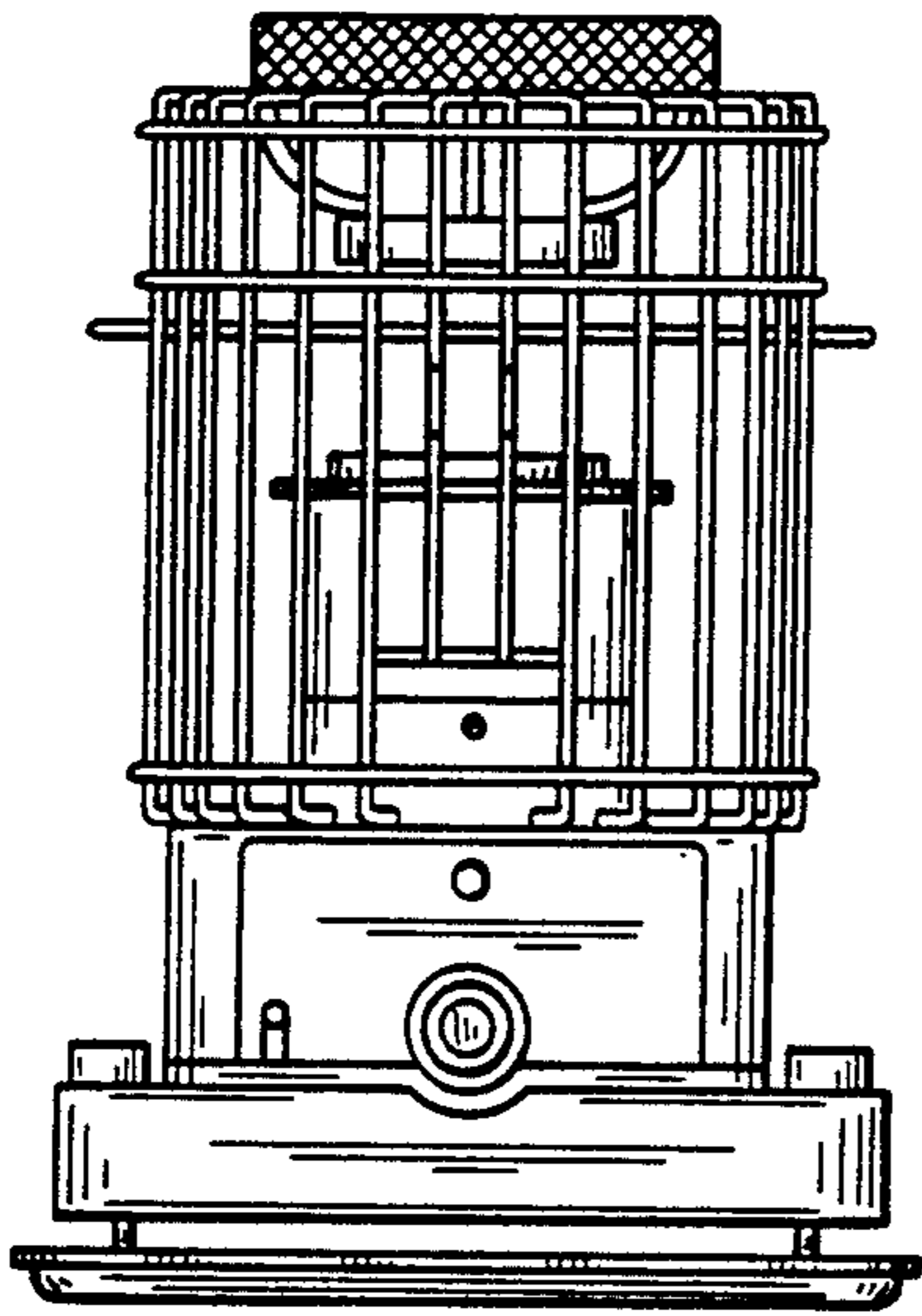

FIG\_2

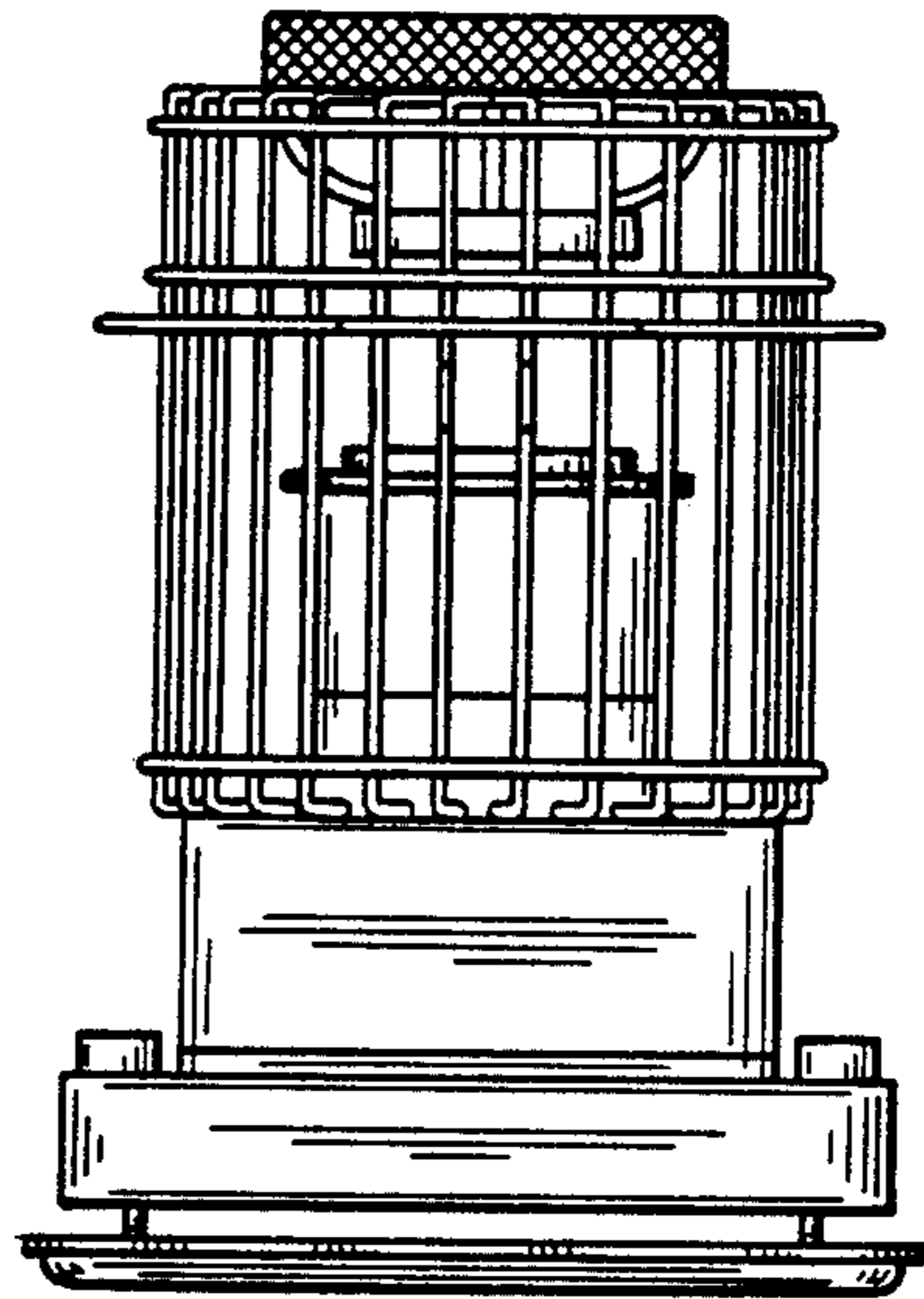

FIG\_3

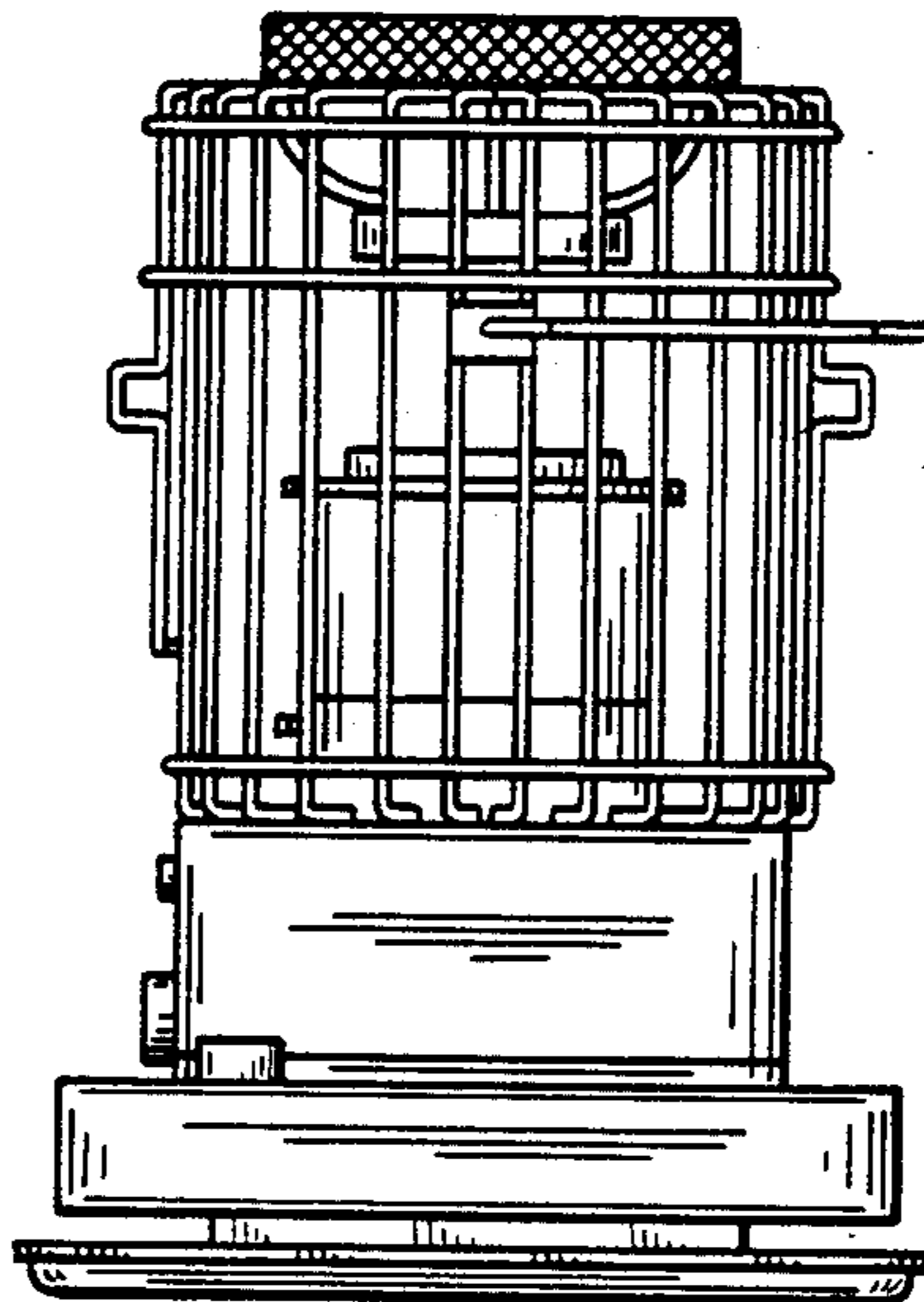

FIG\_4