

[54] STACKABLE END DISPLAY STAND FOR A MERCHANDISING UNIT

[75] Inventor: Stephen N. Hardy, Copley, Ohio

[73] Assignee: American Greetings Corporation, Cleveland, Ohio

[**] Term: 14 Years

[21] Appl. No.: 775,632

[22] Filed: Sep. 16, 1985

[52] U.S. Cl. D6/474

[58] Field of Search D6/466, 475, 467, 474, D6/476; 211/55; 40/10 D, 124, 124.2, 124.4

[56] References Cited

U.S. PATENT DOCUMENTS

D. 106,552	10/1937	West	D6/474
D. 144,749	5/1946	Weston	D6/474
D. 269,074	5/1983	Spak	D6/474 X
2,067,051	1/1937	Hall	211/55
2,283,301	5/1942	Waddell	312/118
4,162,014	7/1979	Bobrick	211/50

Primary Examiner—Carmen H. Vales

Attorney, Agent, or Firm—Baldwin, Egan & Fetzer

[57] CLAIM

The ornamental design for a stackable end display stand for a merchandising unit, as shown and described.

DESCRIPTION

FIG. 1 is a front perspective view of a stackable end display stand for a merchandising unit showing my new design;

FIG. 2 is a right side elevational view thereof;

FIG. 3 is a left side elevational view thereof;

FIG. 4 is a top plan view thereof;

FIG. 5 is a rear elevational view thereof;

FIG. 6 is a bottom plan view thereof;

FIG. 7 is a perspective view, the broken lines indicate environmental structure and forms no part of the claimed design;

FIG. 8 is an enlarged top plan view of one of the stackable units shown separately for convenience of illustration;

FIG. 9 is front elevational view thereof;

FIG. 10 is an end elevational view thereof;

FIG. 11 is a rear elevational view thereof; and

FIG. 12 is a bottom plan view thereof.

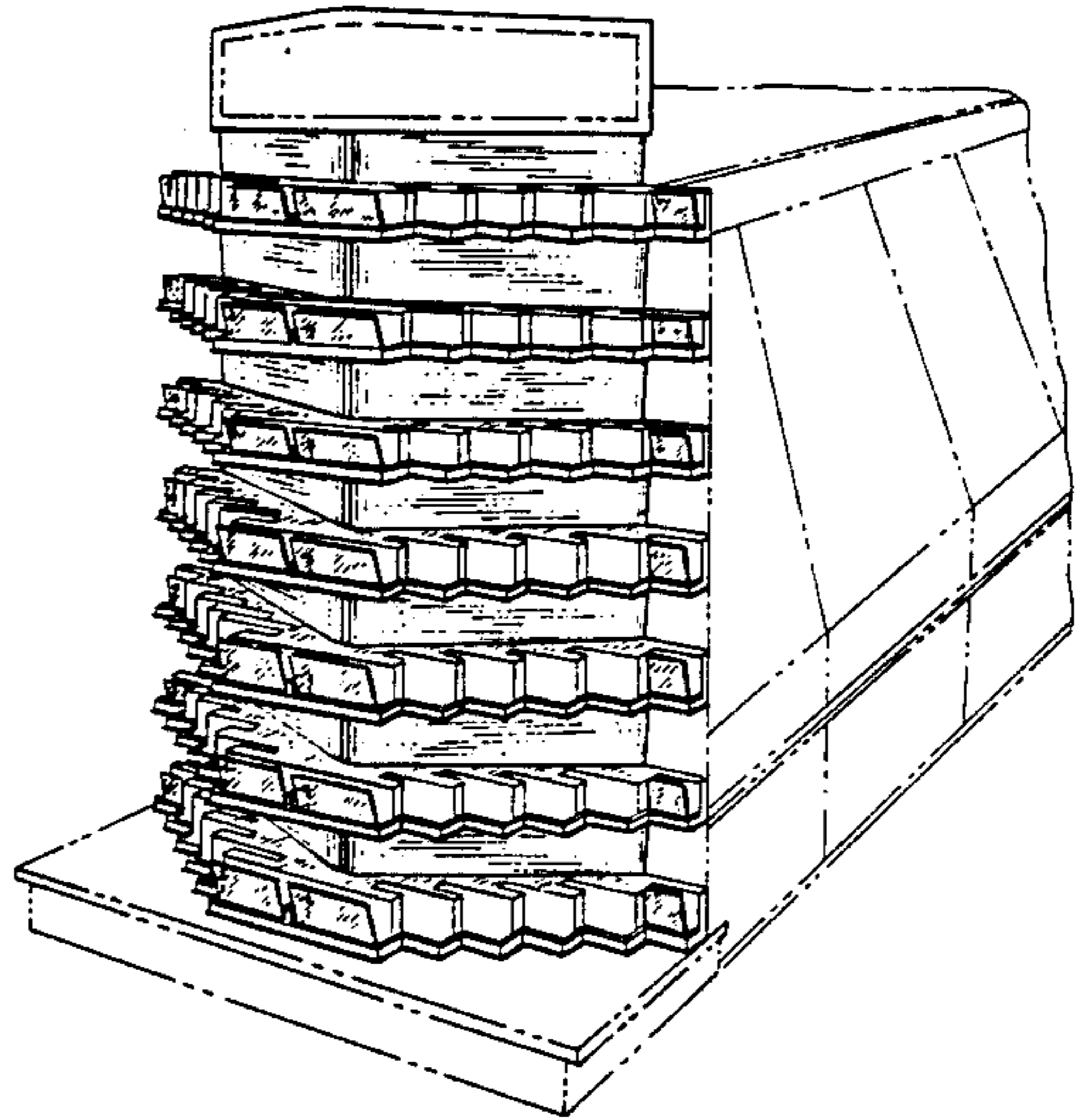
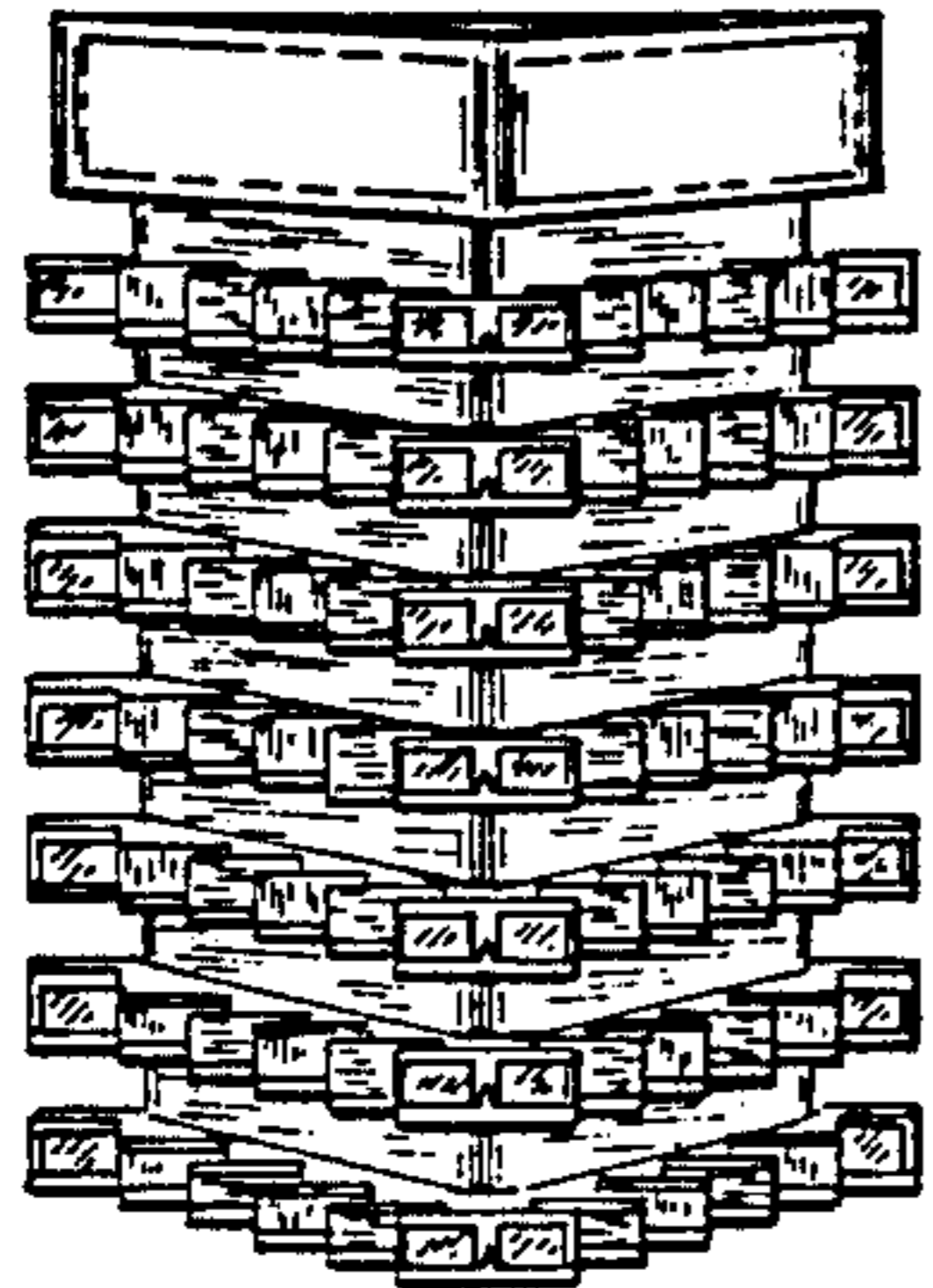

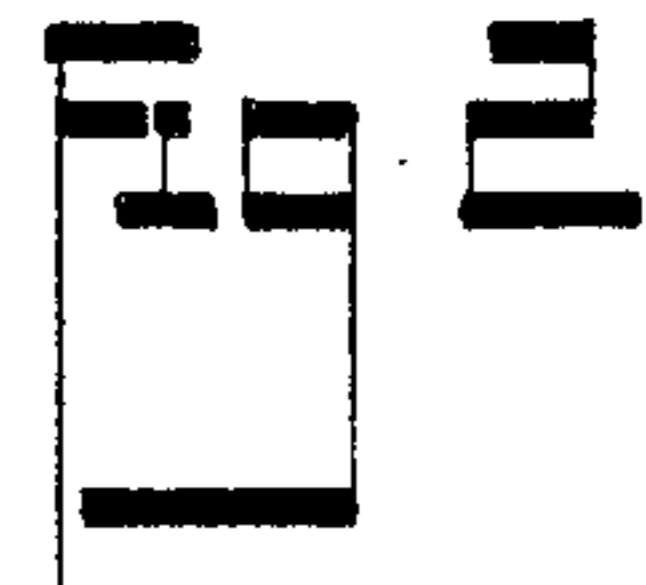
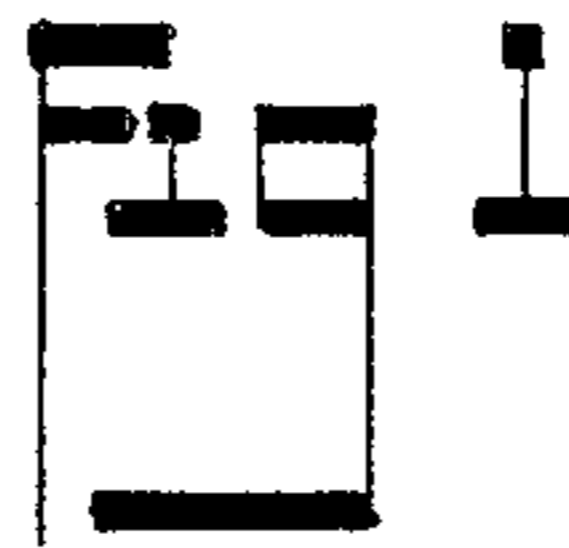
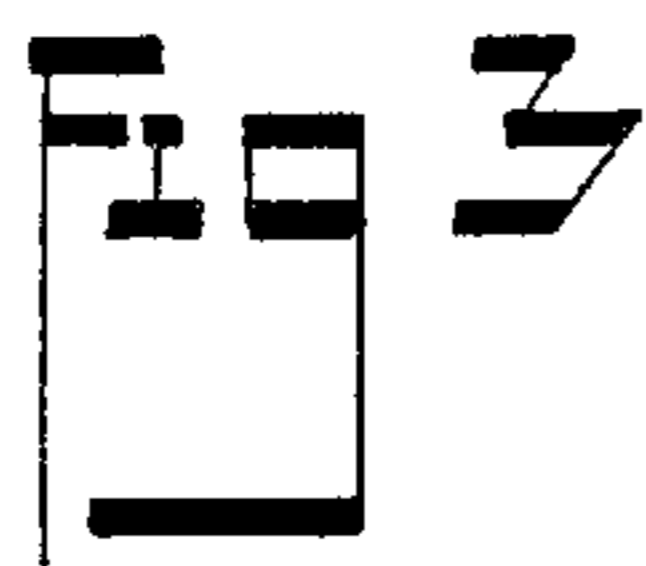
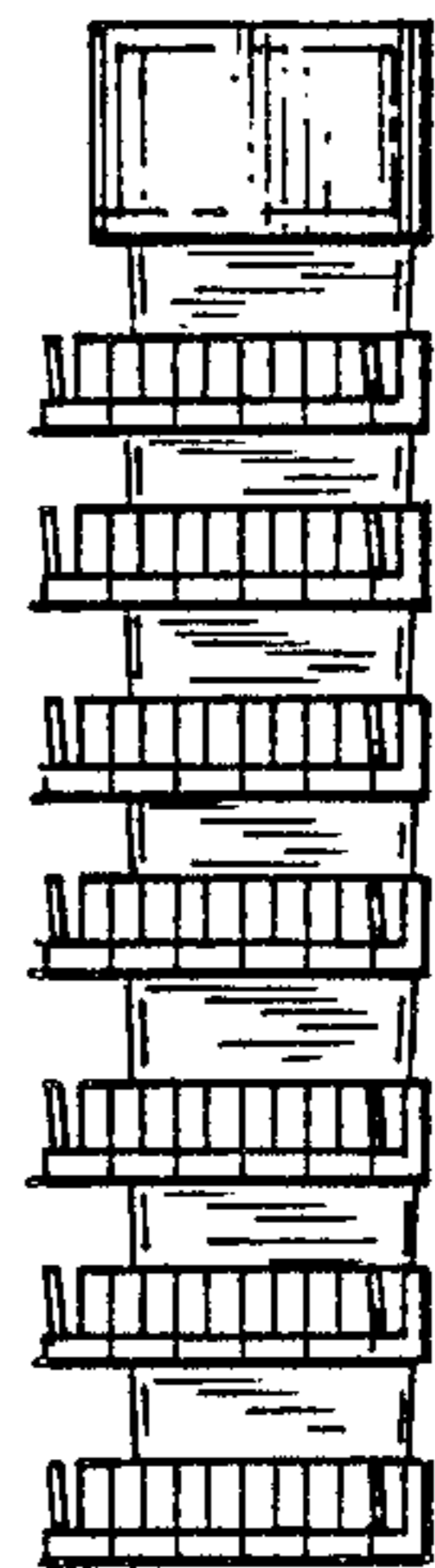
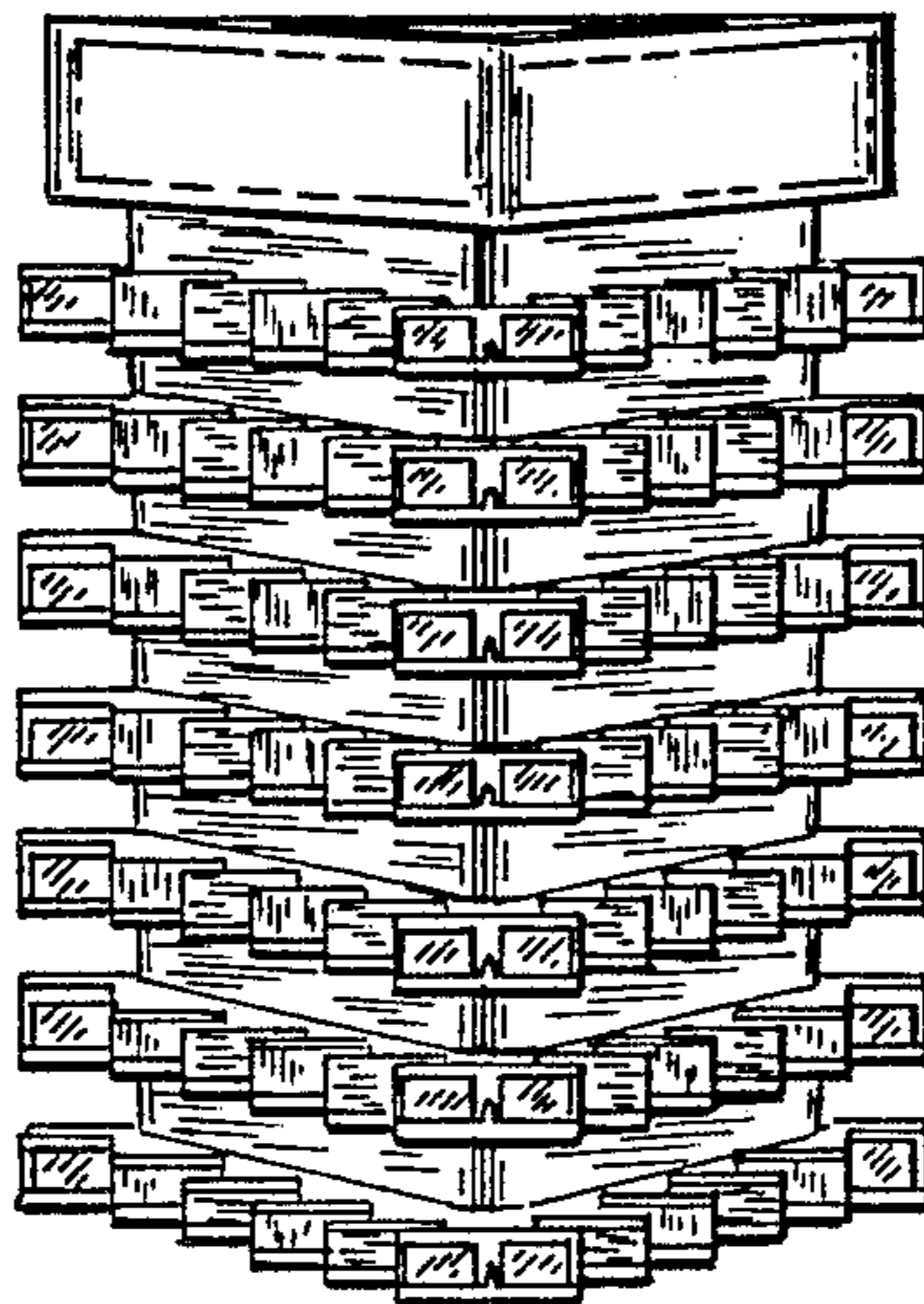
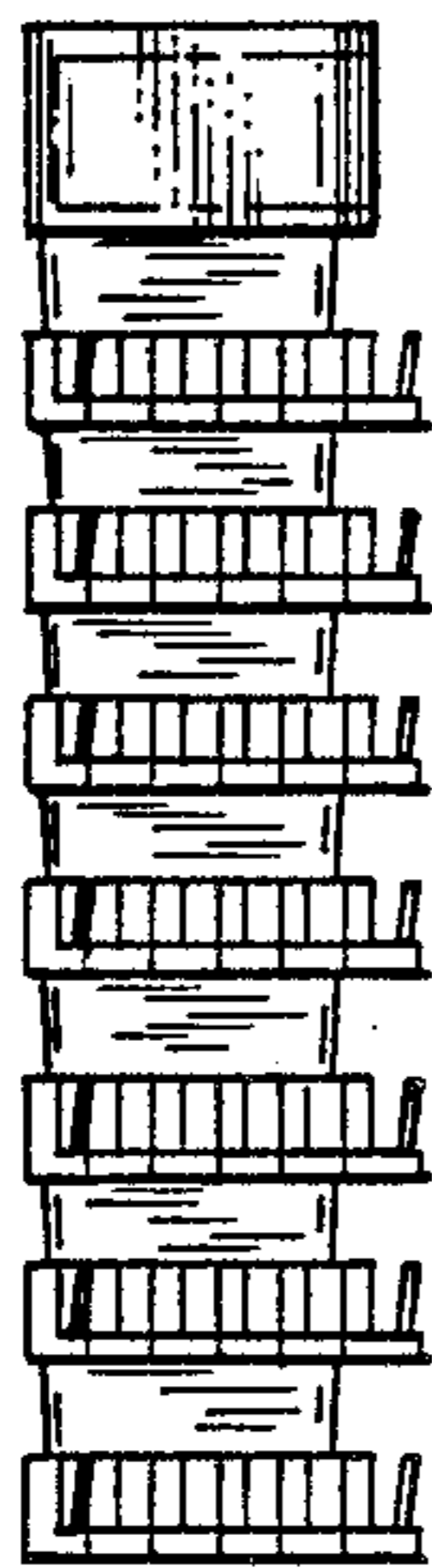
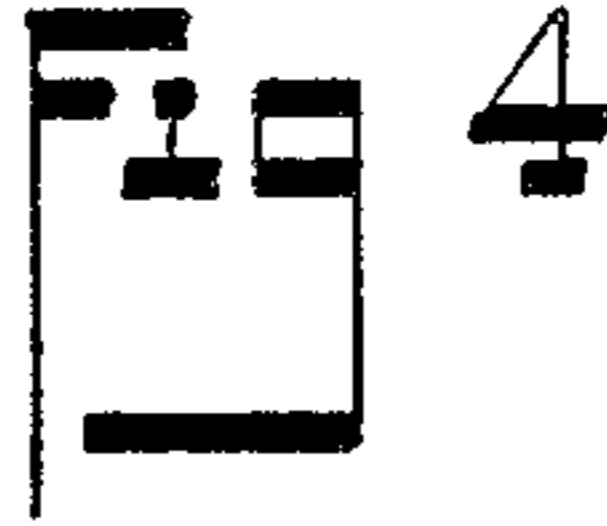
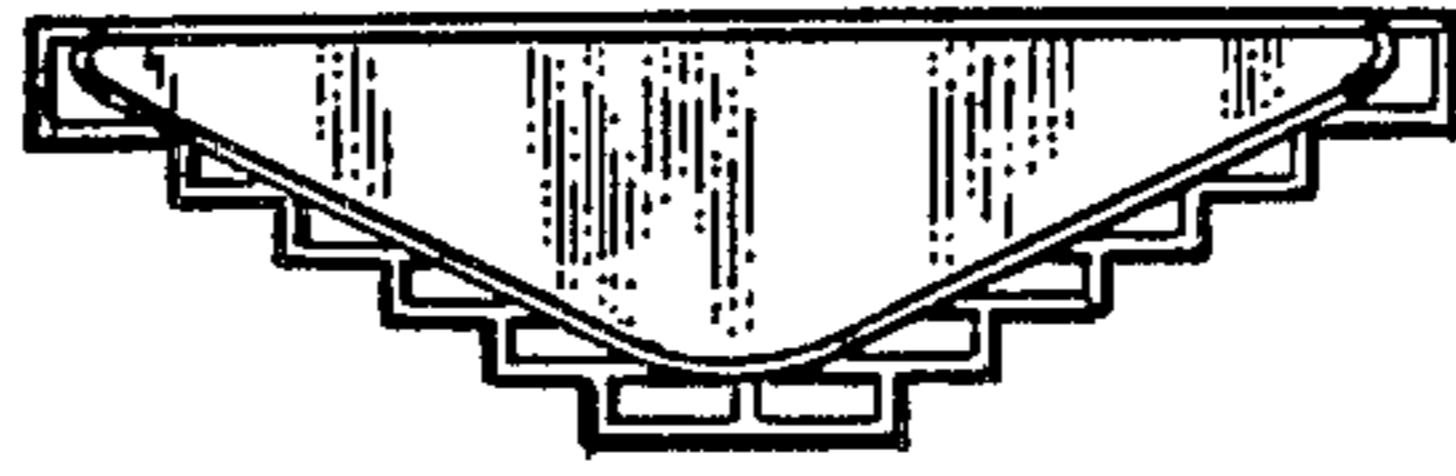

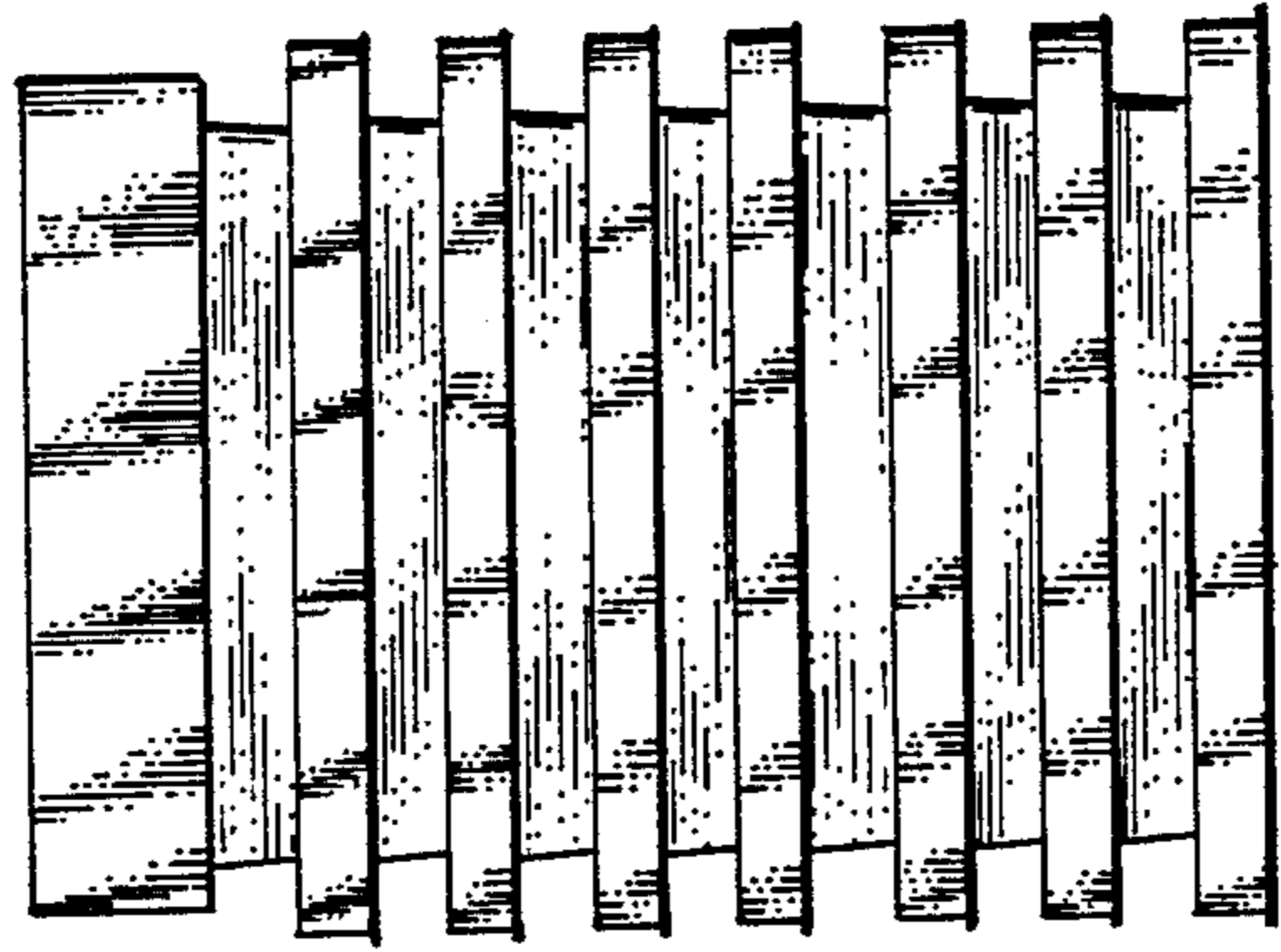

Fig. 5

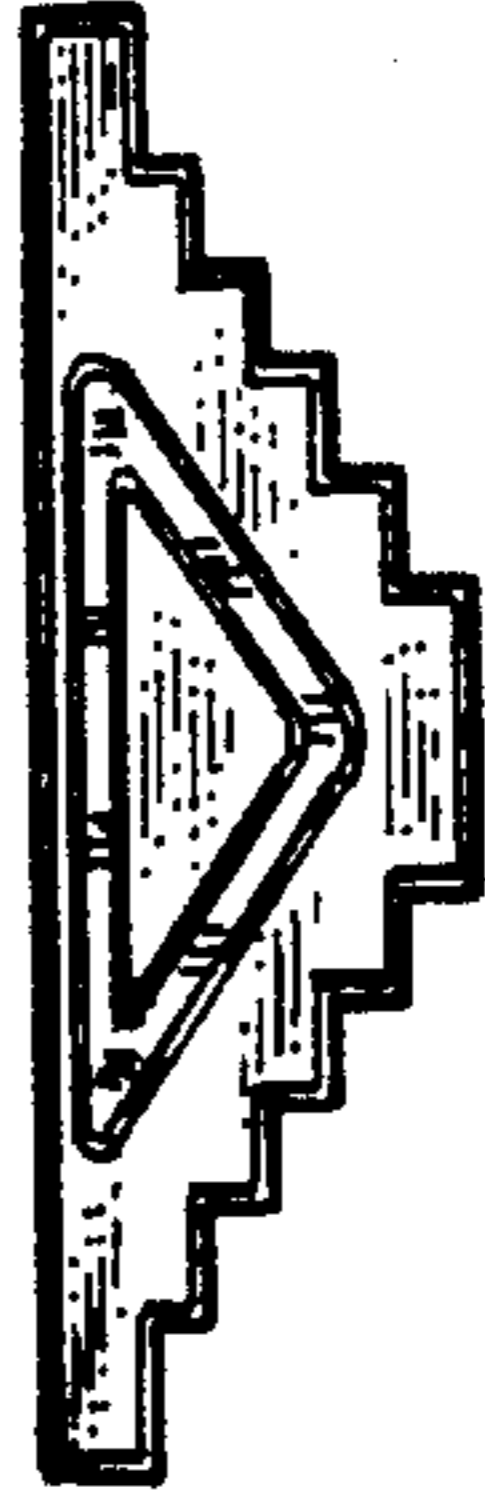

Fig. 6

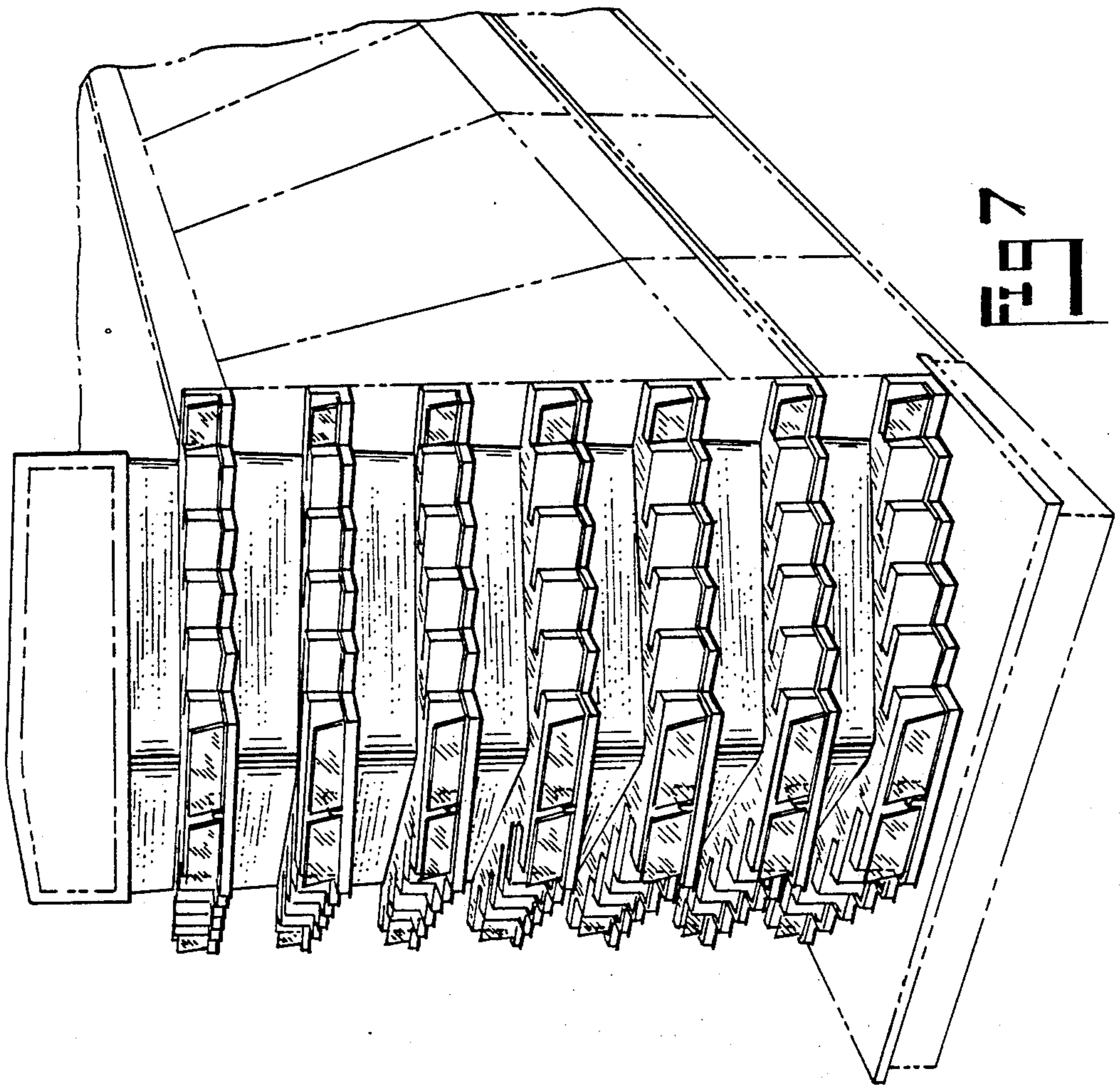

Fig. 7

