

[54] ROTATABLE MERCHANDISING DISPLAY UNIT

[75] Inventor: Stephen N. Hardy, Copley, Ohio

[73] Assignee: American Greetings Corporation, Cleveland, Ohio

[**] Term: 14 Years

[21] Appl. No.: 776,696

[22] Filed: Sep. 16, 1985

[52] U.S. Cl. D6/457; D6/461

[58] Field of Search D6/455, 457, 458, 459, D6/460, 461; 211/13, 58, 56, 131

[56] References Cited

U.S. PATENT DOCUMENTS

D. 76,672	10/1928	Ellis	D6/455
D. 206,201	11/1966	Kingsford et al.	D6/457
D. 259,315	5/1981	Ford et al.	D6/458 X
D. 265,024	6/1982	Johnson et al.	D6/24
D. 284,818	7/1986	Zaro et al.	D6/461
1,235,225	7/1917	Miller	211/58
2,953,257	9/1960	McNeill	211/131
2,972,415	2/1961	Rensch	D6/461 X

OTHER PUBLICATIONS

Clear Solutions Inc. advertisement from Sep. 1985 Greetings Magazine.

Primary Examiner—Carmen H. Vales
Attorney, Agent, or Firm—Baldwin, Egan & Fetzer

[57] CLAIM

The ornamental design for a rotatable merchandising display unit, as shown and described.

DESCRIPTION

FIG. 1 is a perspective view of a rotatable merchandising display unit showing my new design;
 FIG. 2 is a top plan view thereof;
 FIG. 3 is a right side elevational view thereof;
 FIG. 4 is an enlarged perspective view of one of the receptacles shown separately for convenience of illustration;
 FIG. 5 is a perspective view of a second embodiment of the rotatable merchandising display unit shown in FIG. 1;
 FIG. 6 is a top plan view thereof;
 FIG. 7 is a side elevational view thereof;
 FIG. 8 is a front elevational view thereof; and
 FIG. 9 is a third embodiment of the rotatable merchandising display unit shown in FIG. 1.

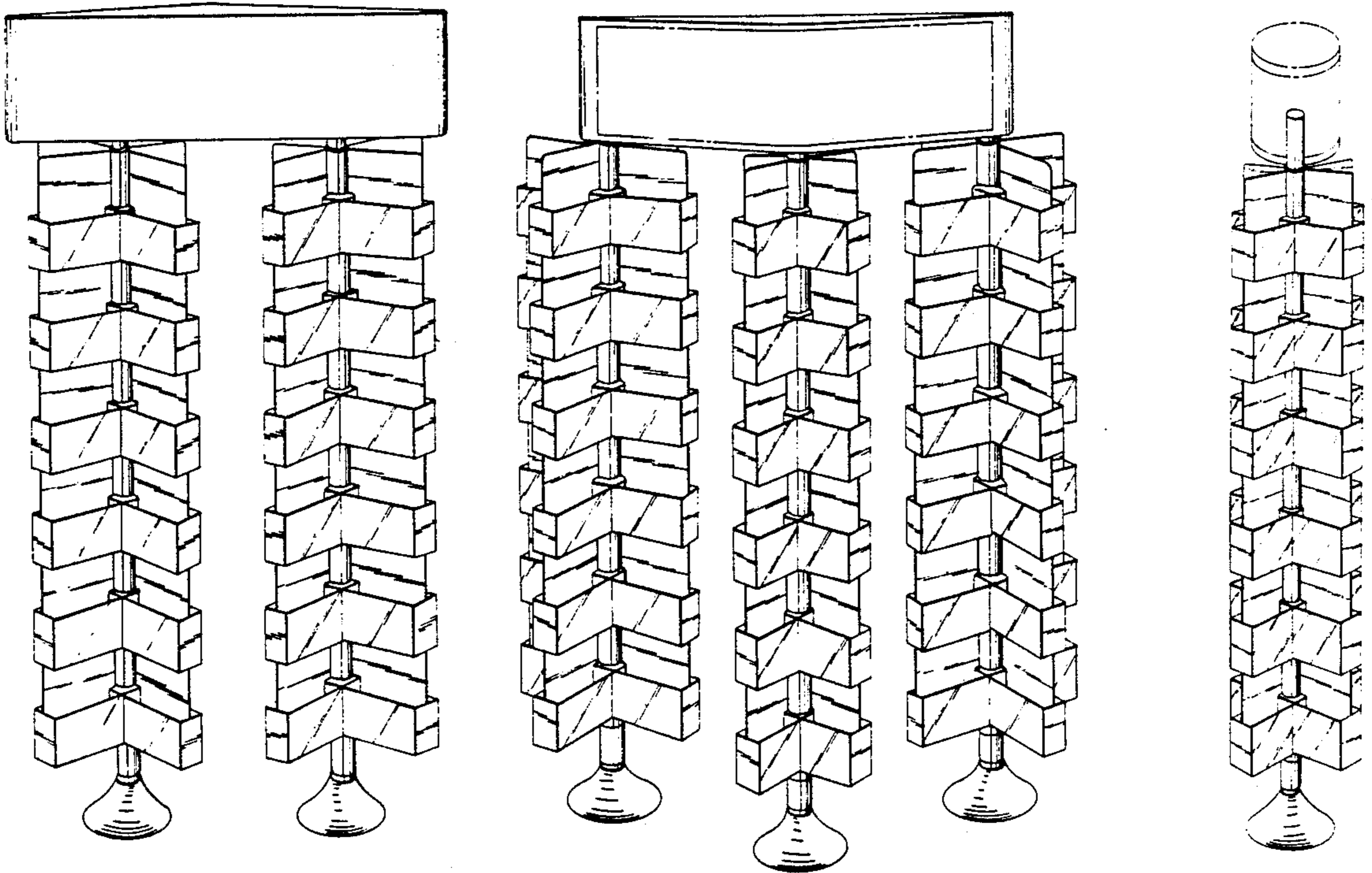

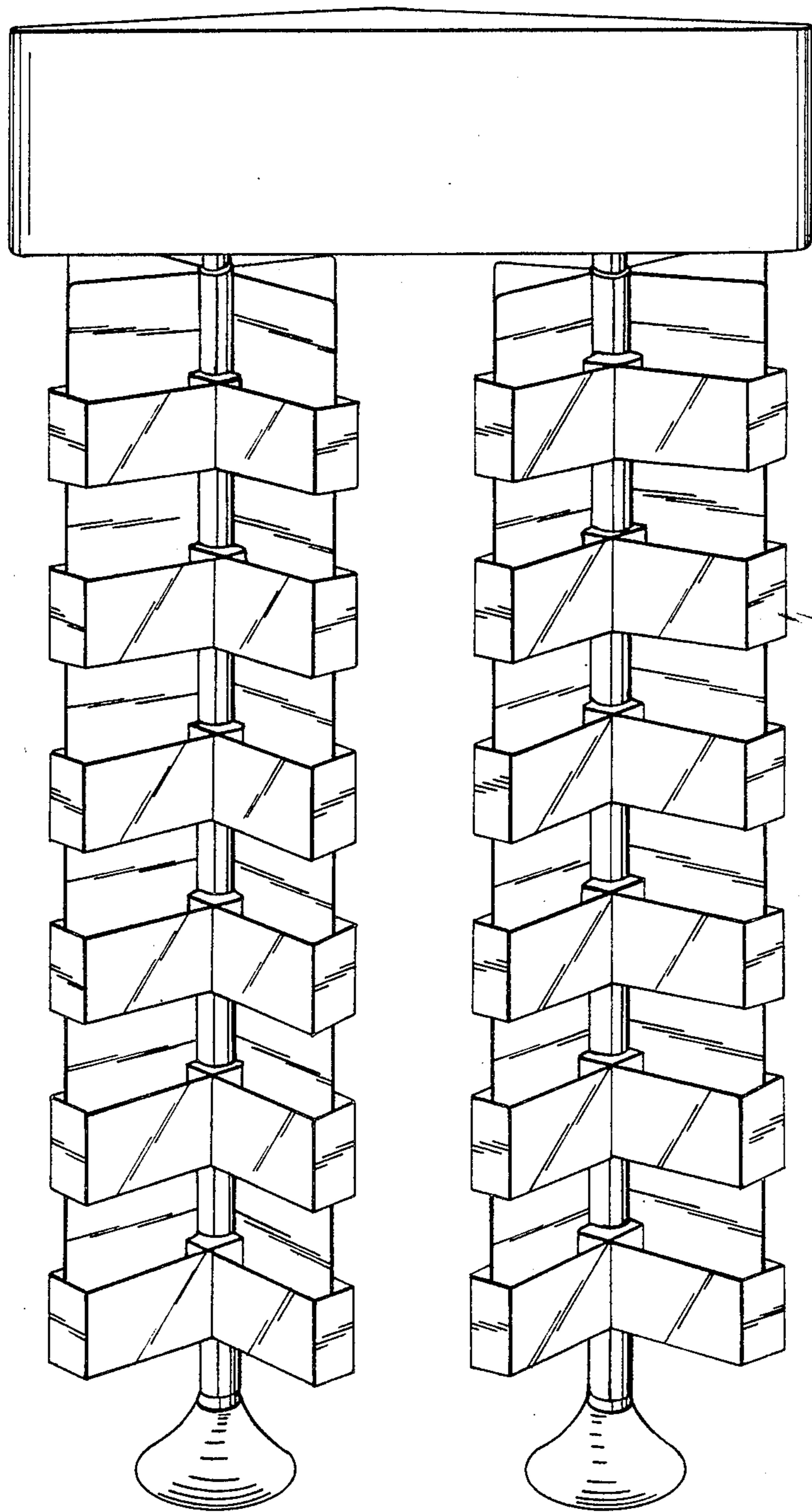

Fig. 1

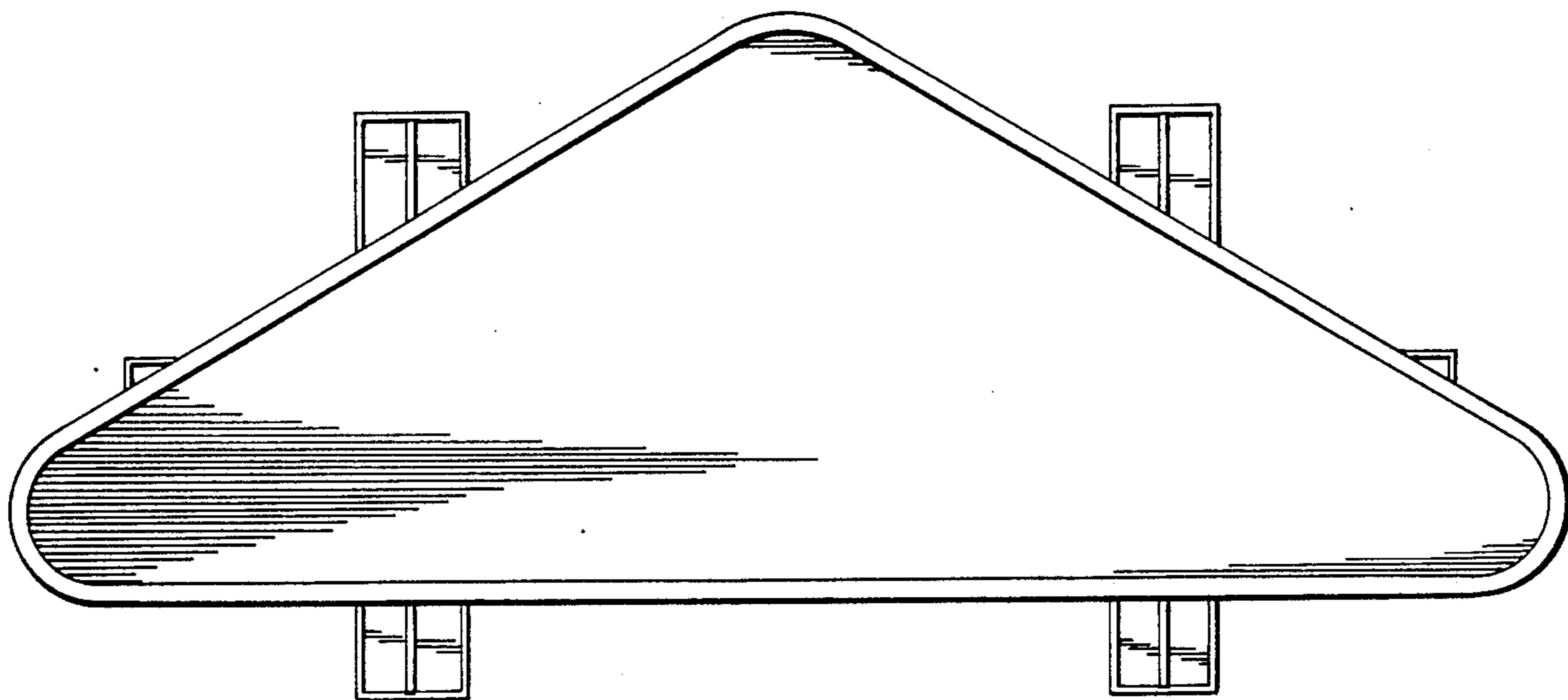

Fig. 2

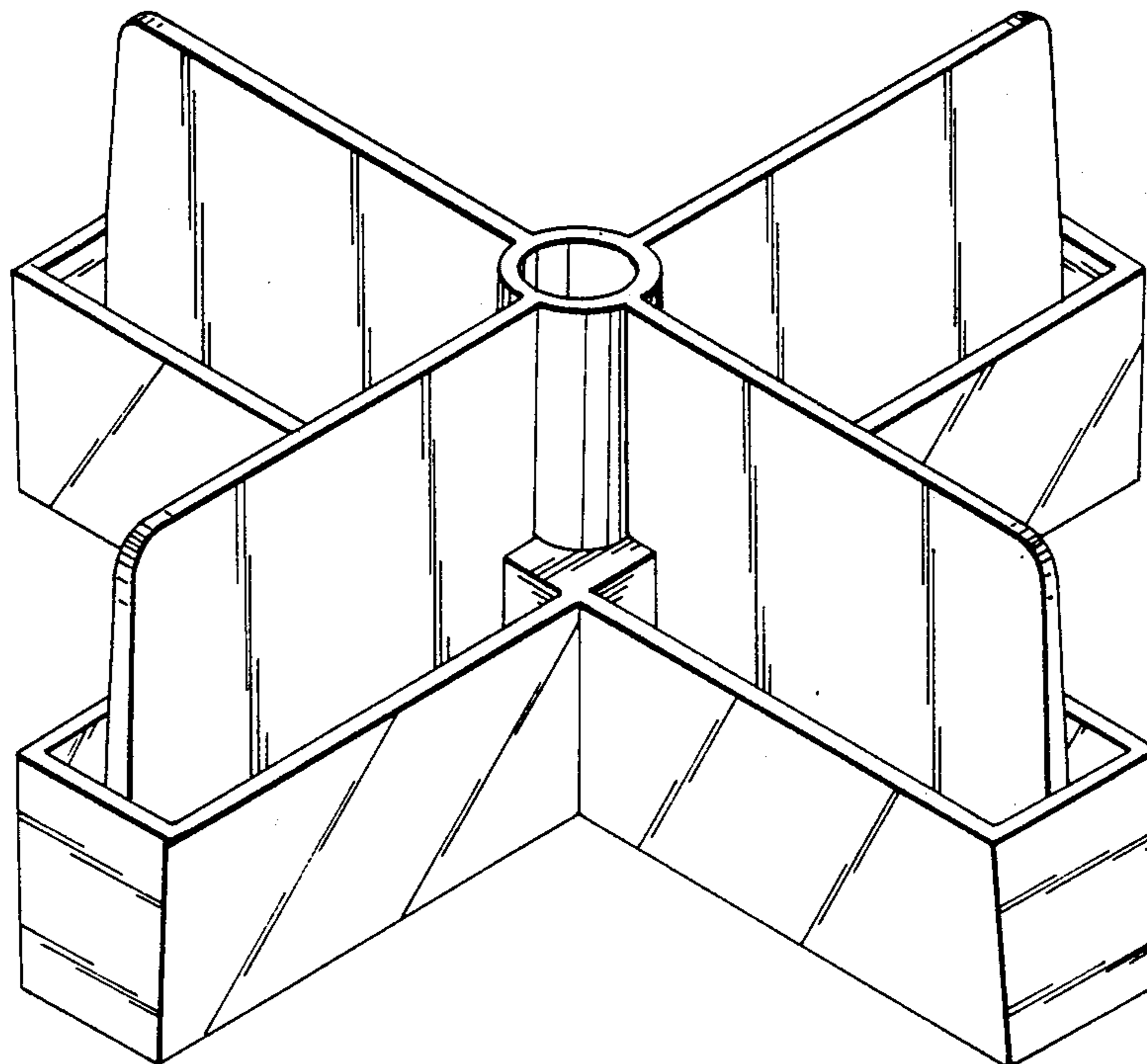
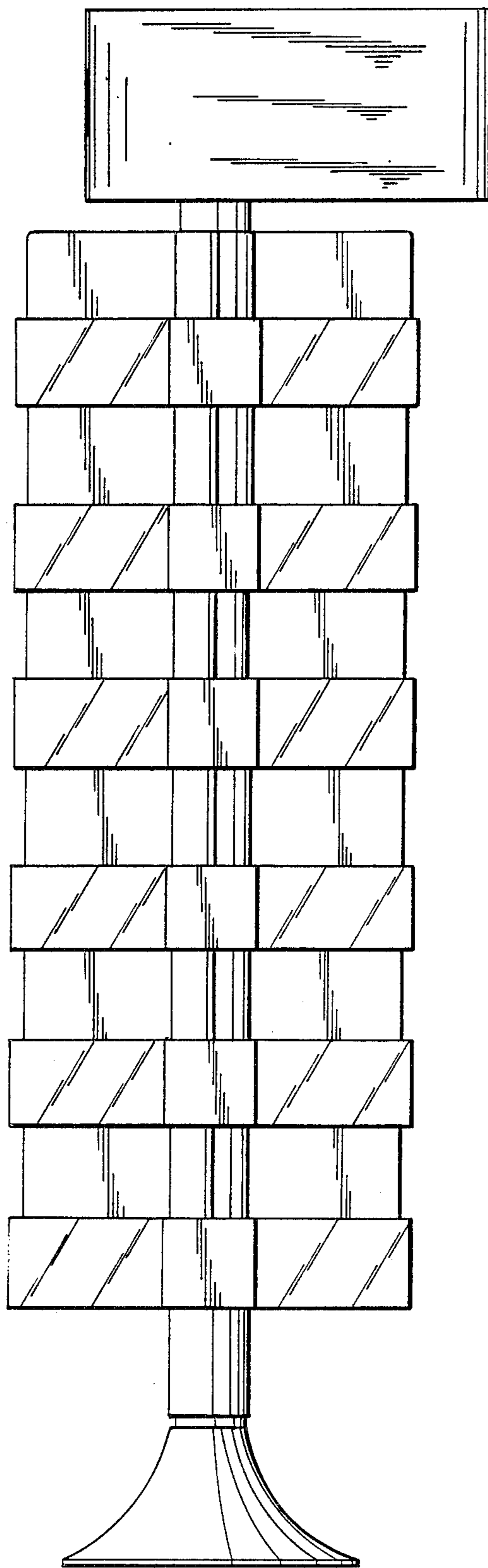

Fig. 4

Fig. 3



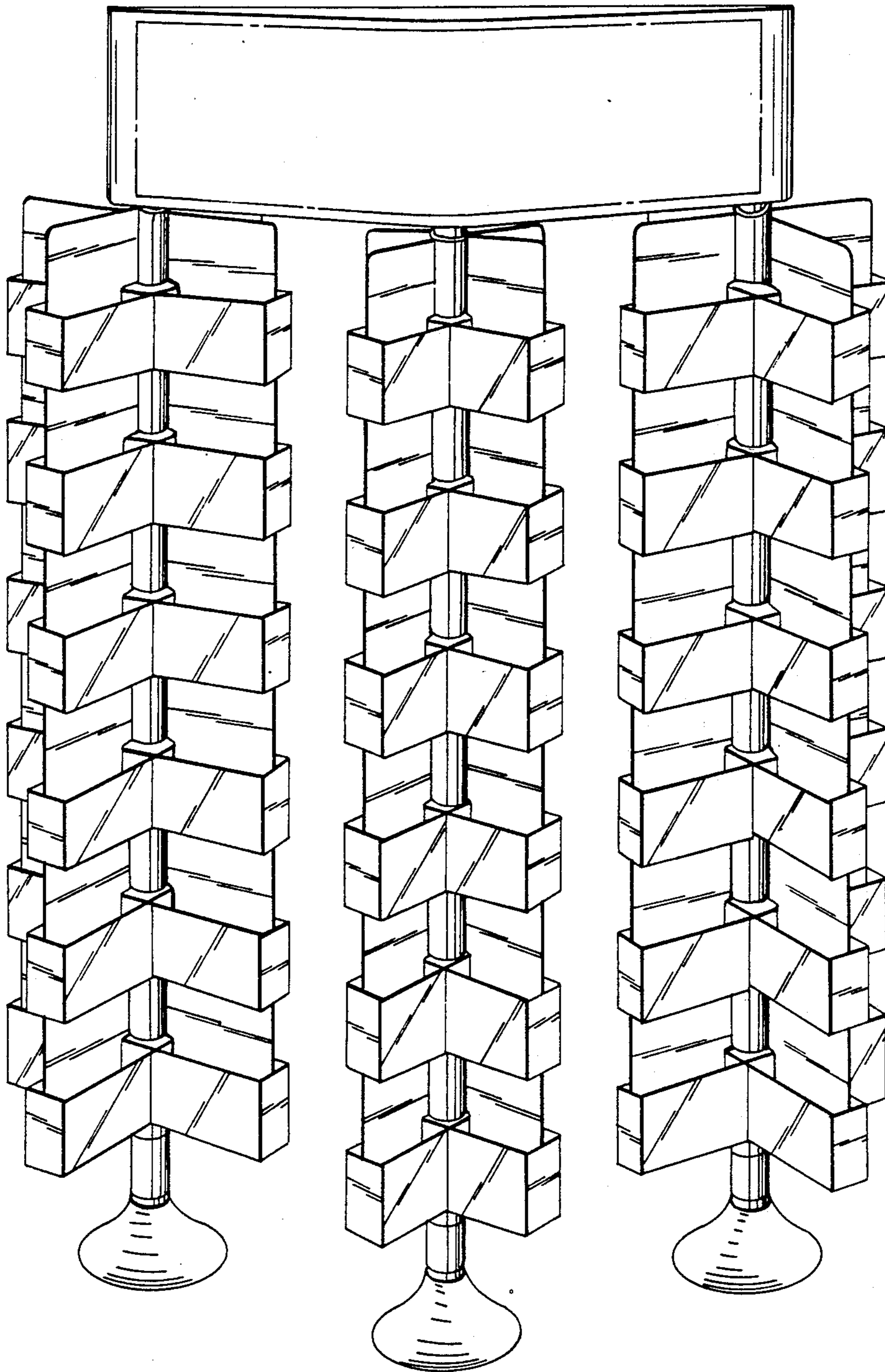

Fig. 5

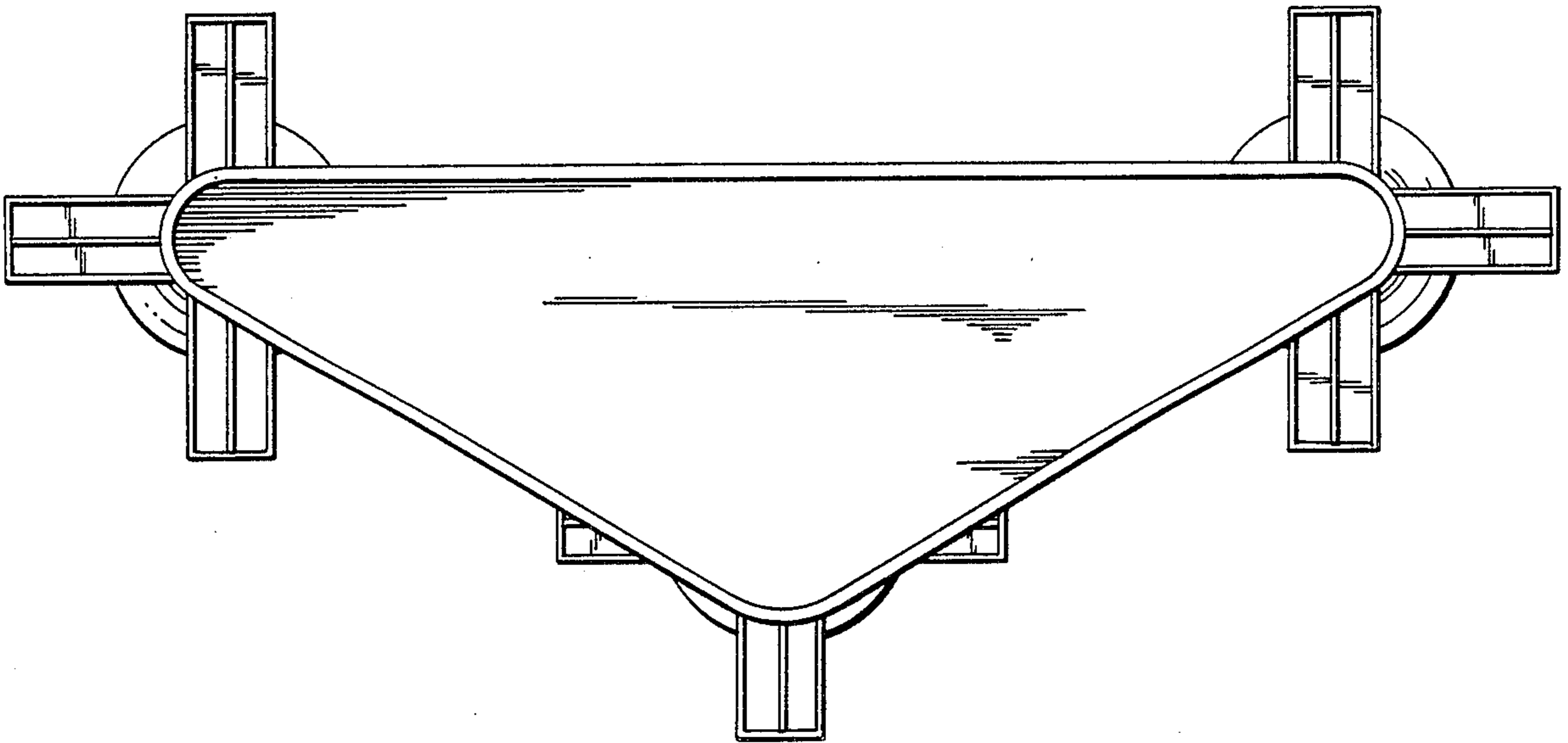

Fig. 6

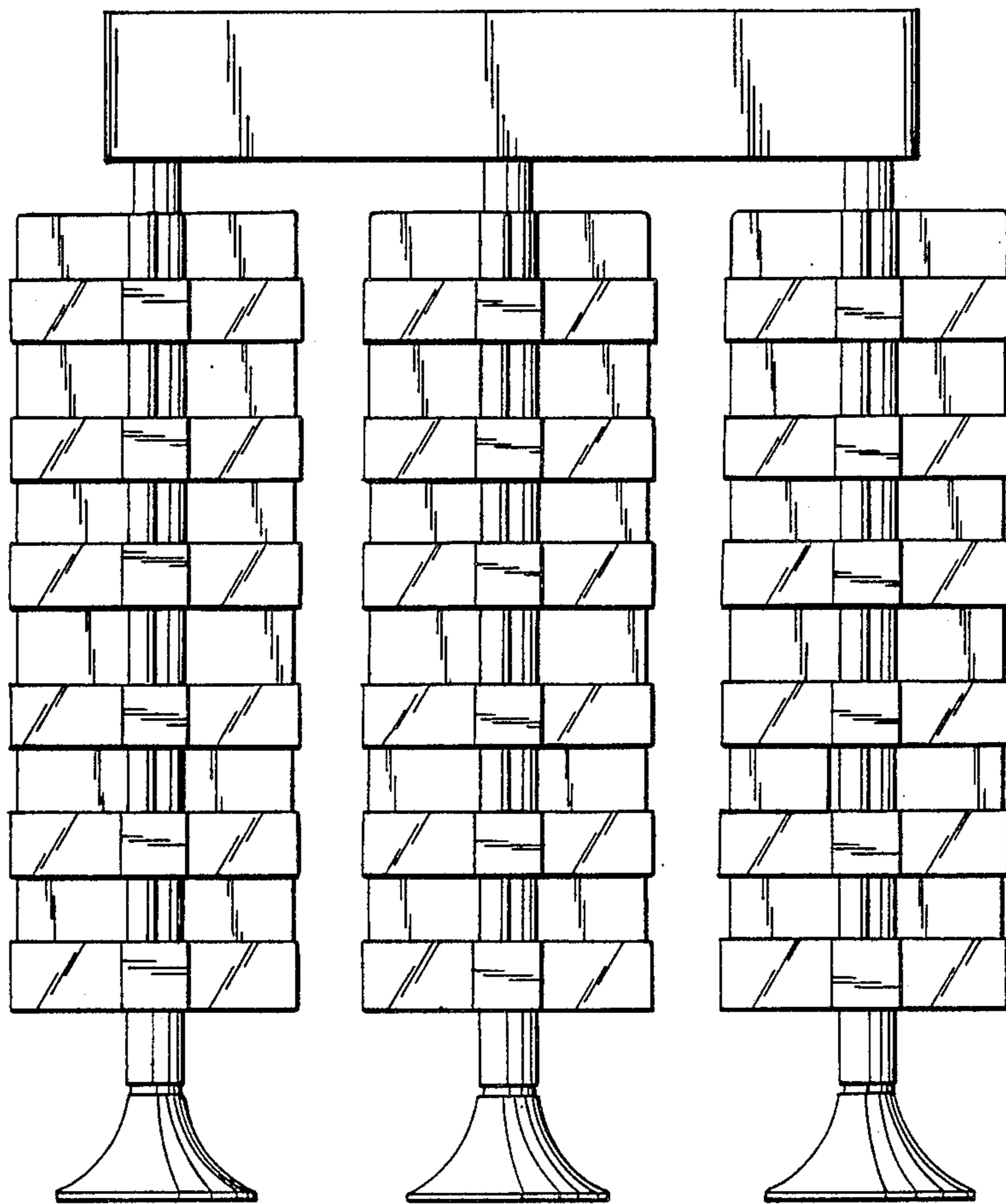

Fig. 8

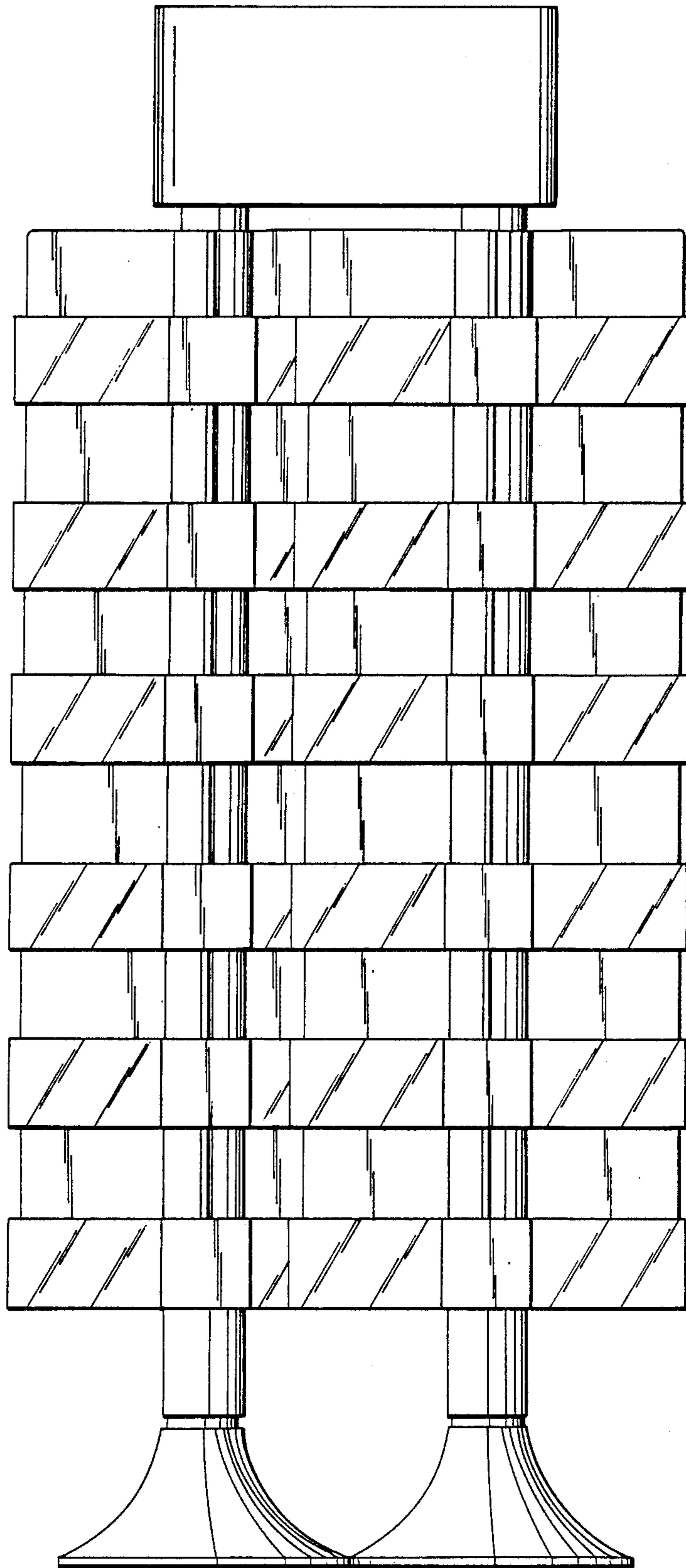

Fig. 7

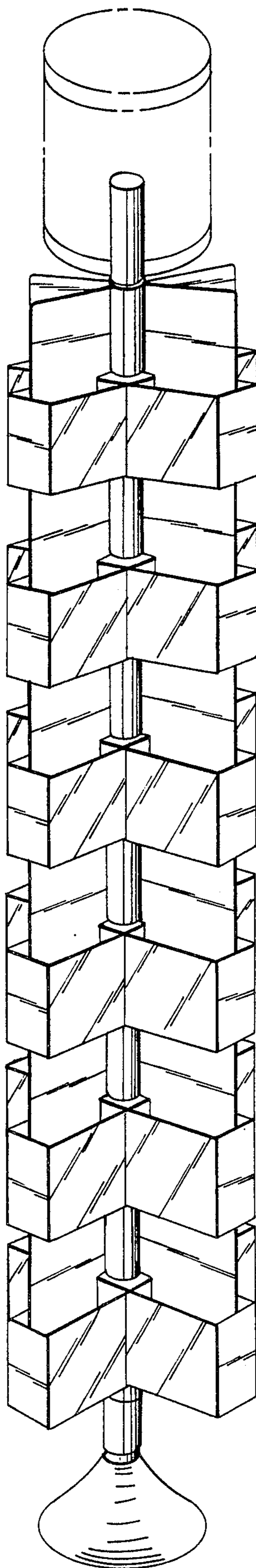

Fig. 9