

[54] ELECTRONIC CASH REGISTER

[75] Inventors: Kenji Kojima, Hamuramachi; Masao Suto, Kunitachi; Koji Shindoh, Fusa, all of Japan

[73] Assignee: Casio Computer Co., Ltd., Tokyo, Japan

[\*\*] Term: 14 Years

[21] Appl. No.: 790,410

[22] Filed: Oct. 23, 1985

[30] Foreign Application Priority Data

May 11, 1985 [JP] Japan ..... 60-19503

[52] U.S. Cl. .... D18/4

[58] Field of Search ..... D18/3, 4, 11, 12, 13, D18/14, 99; D14/100, 109; 364/405, 406, 407

[56] References Cited

U.S. PATENT DOCUMENTS

- D. 260,100 8/1981 Sakamoto ..... D18/4
- D. 282,552 2/1986 Koppens ..... D18/4
- D. 286,045 10/1986 McGarvey et al. .... D14/100
- D. 290,845 7/1987 Yubisui et al. .... D14/100 X

FOREIGN PATENT DOCUMENTS

0132662 10/1981 Japan ..... 364/405

Primary Examiner—Bernard Ansher  
Assistant Examiner—Theodore M. Shooman  
Attorney, Agent, or Firm—Frishauf, Holtz, Goodman & Woodward

[57] CLAIM

The ornamental design for an electronic cash register, as shown and described.

DESCRIPTION

FIG. 1 is a front elevational view of an electronic cash register showing our new design;  
 FIG. 2 is a top plan view thereof;  
 FIG. 3 is a right side elevational view thereof;  
 FIG. 4 is a left side elevational view thereof;  
 FIG. 5 is a rear elevational view thereof;  
 FIG. 6 is a bottom plan view thereof;  
 FIG. 7 is a front elevational view thereof with front cover opened;  
 FIG. 8 is a top plan view thereof with front cover opened;  
 FIG. 9 is a right side elevational view thereof with front cover opened;  
 FIG. 10 is a left side elevational view thereof with front cover opened;  
 FIG. 11 is a rear elevational view thereof with front cover opened;  
 FIG. 12 is a perspective view thereof; and  
 FIG. 13 is a perspective view thereof with front cover opened.

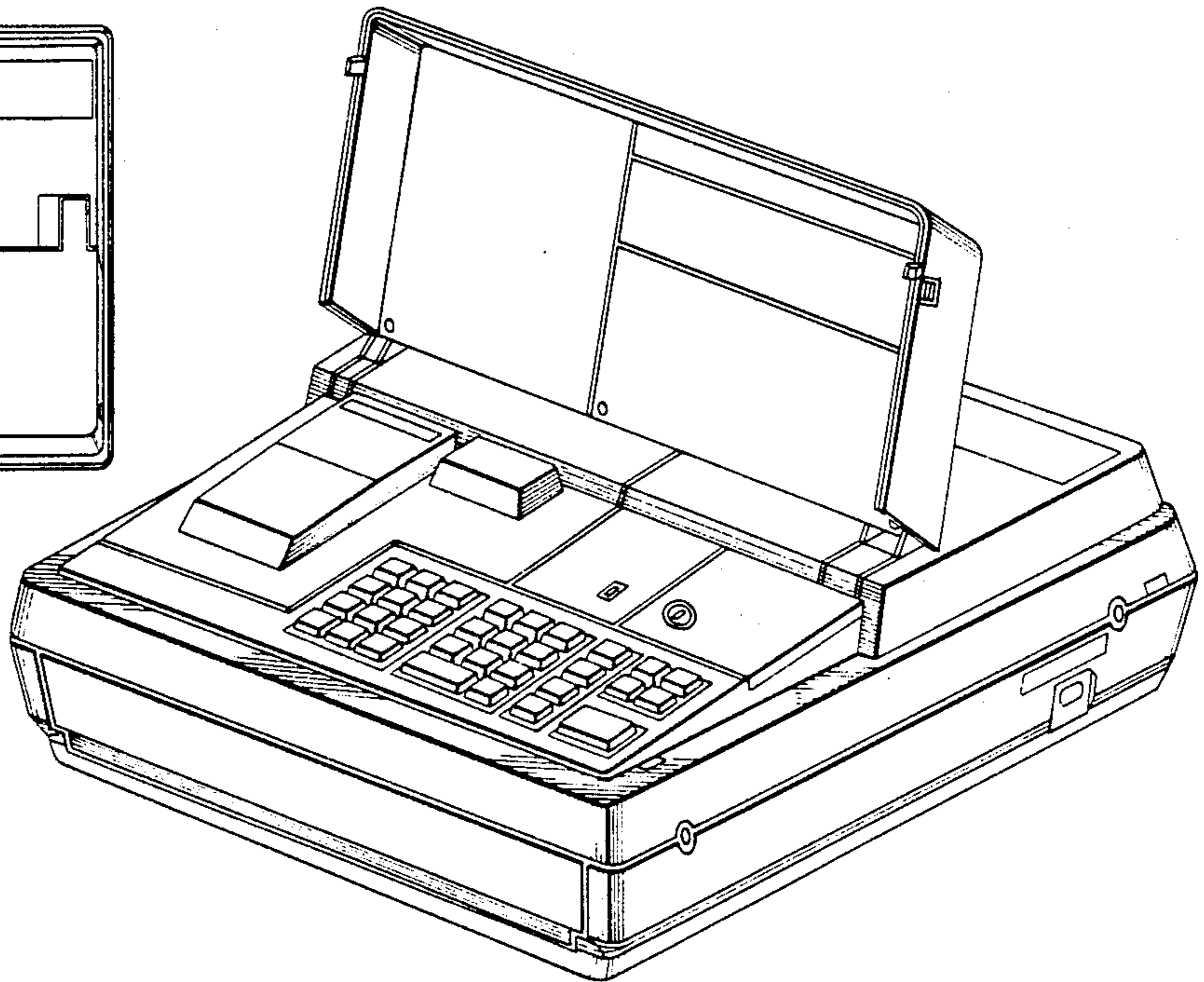
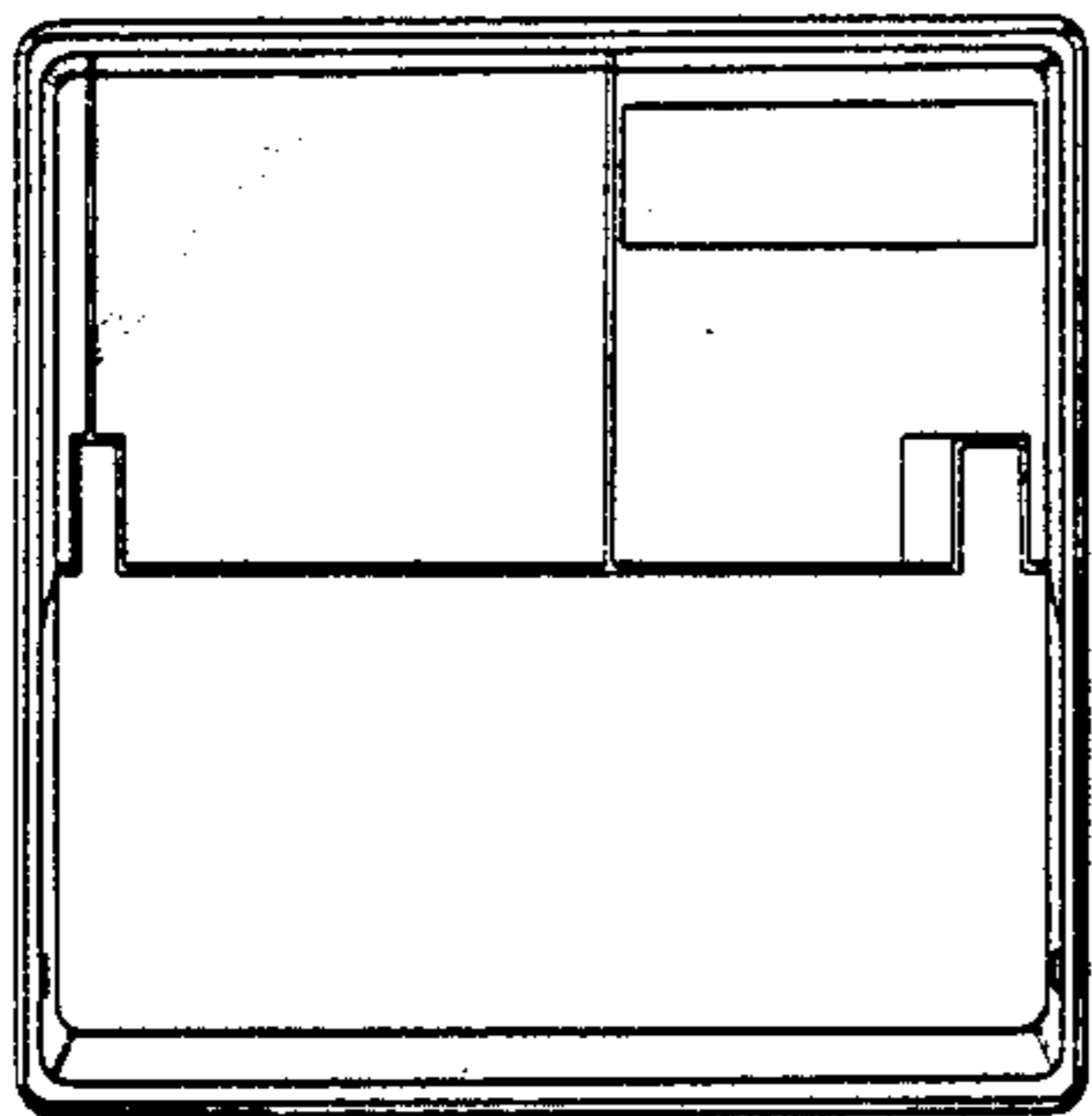
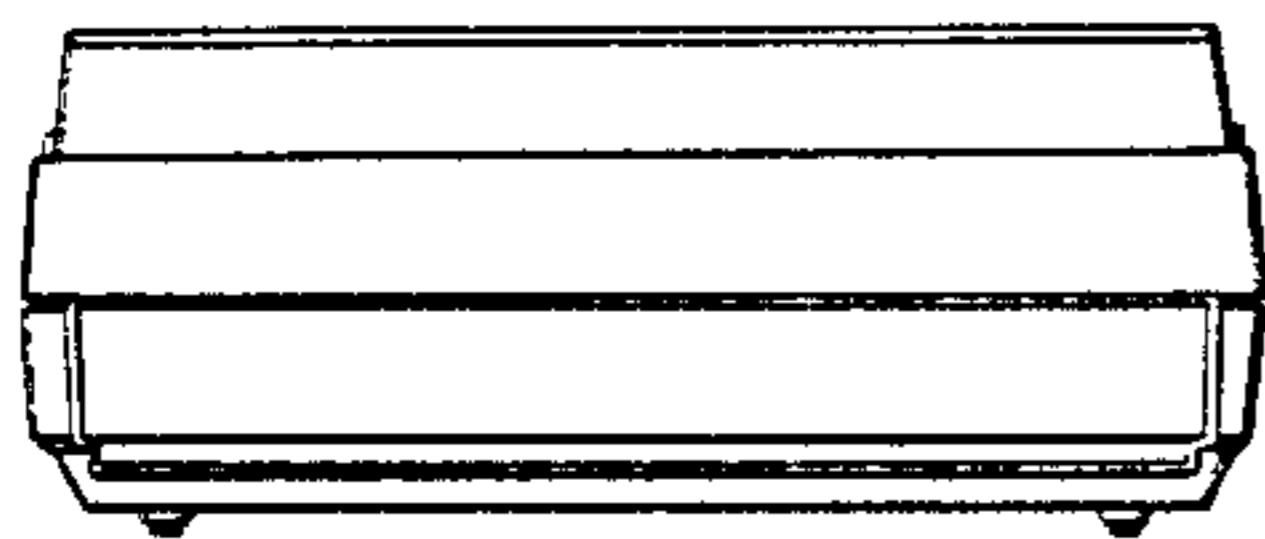

FIG. 1

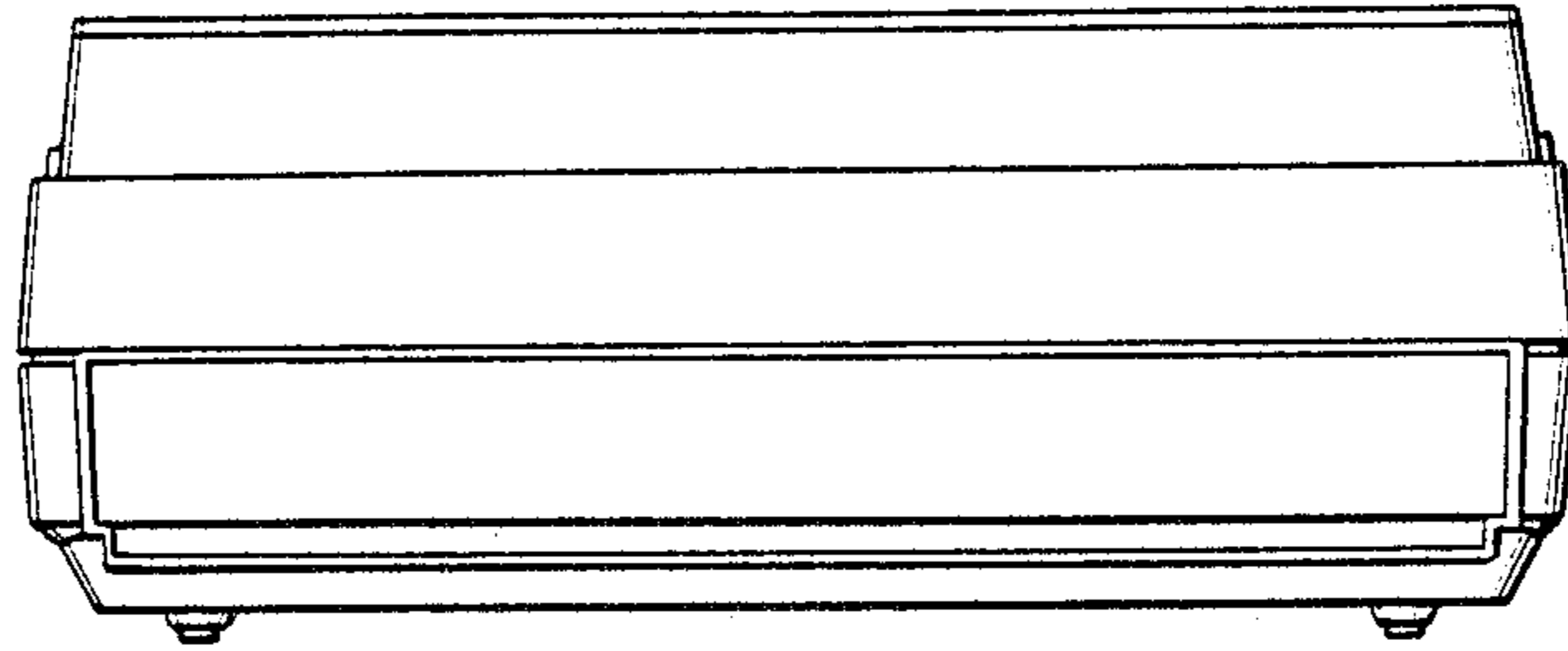

FIG. 2

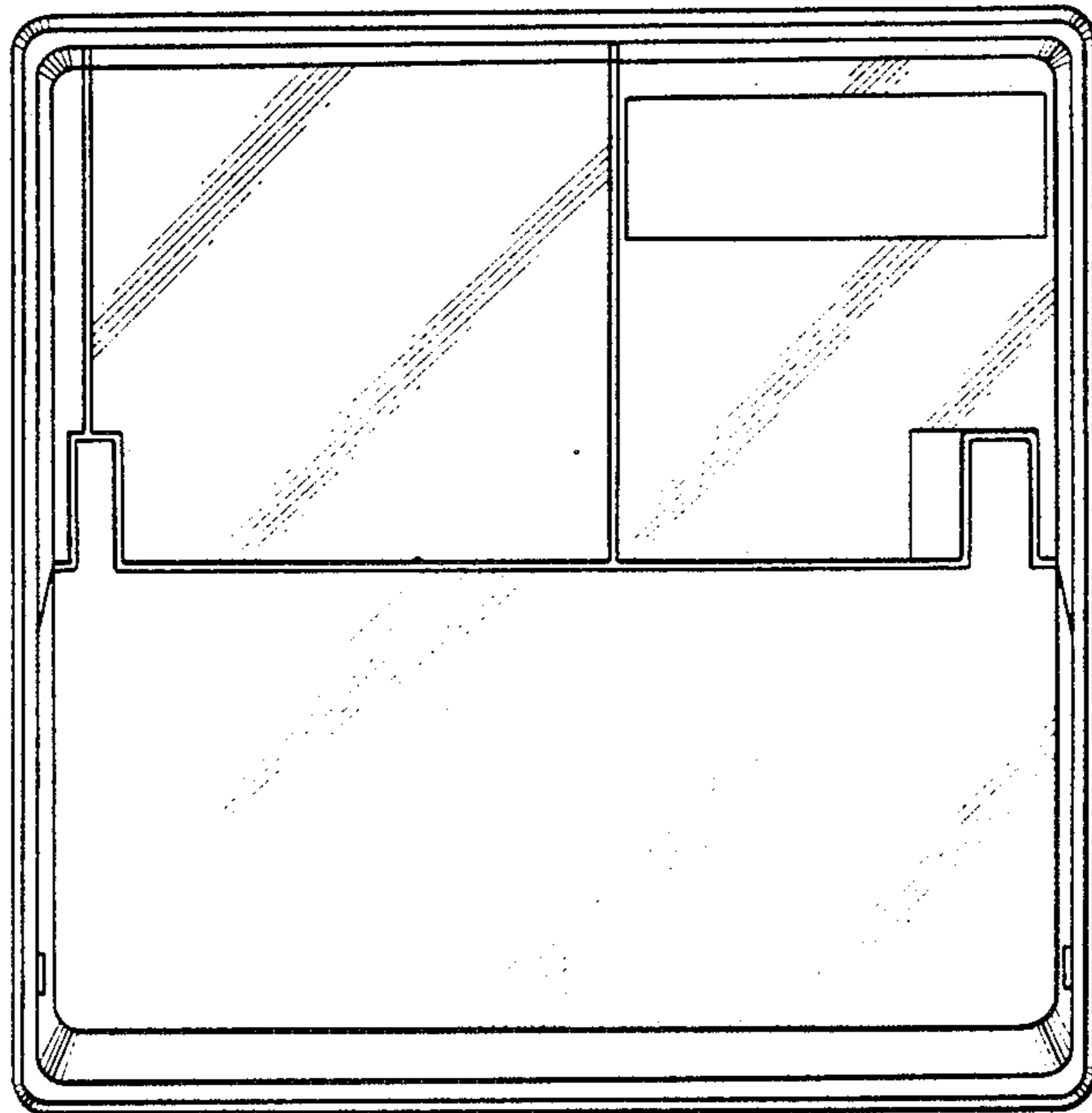

FIG. 3

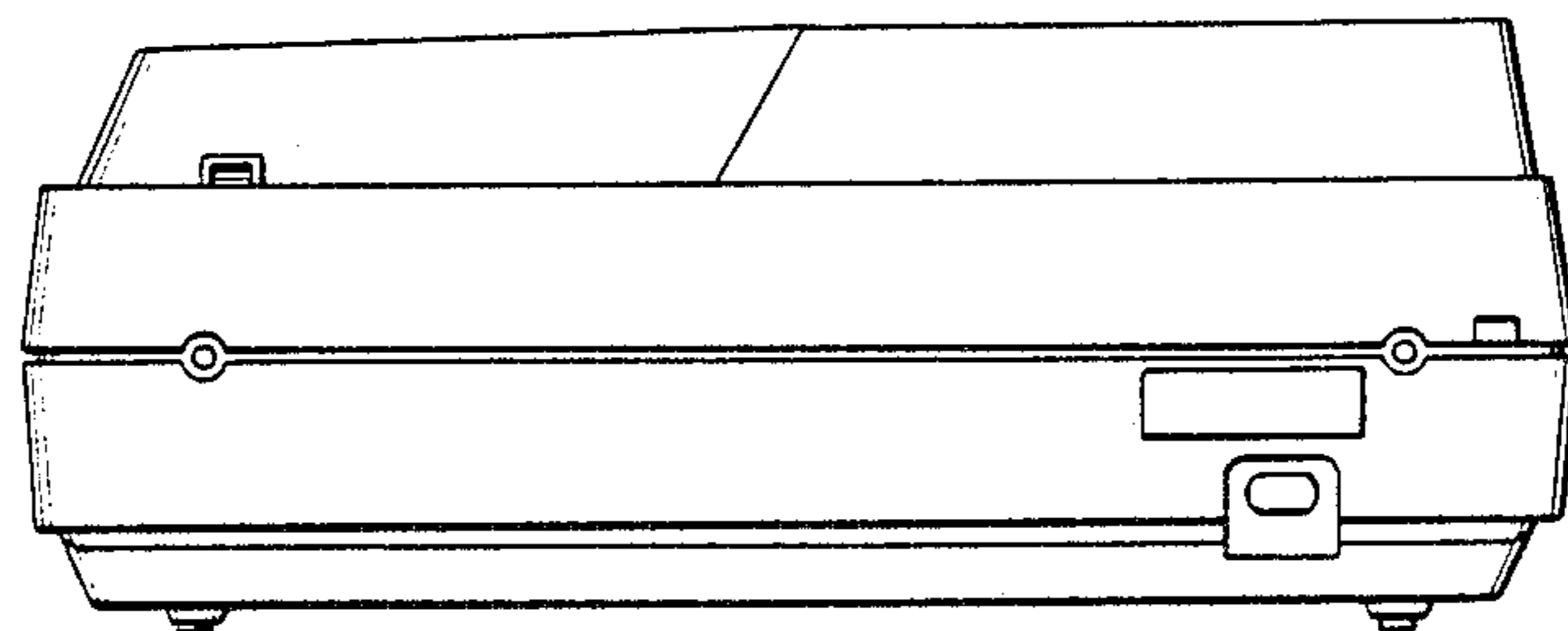

FIG. 4

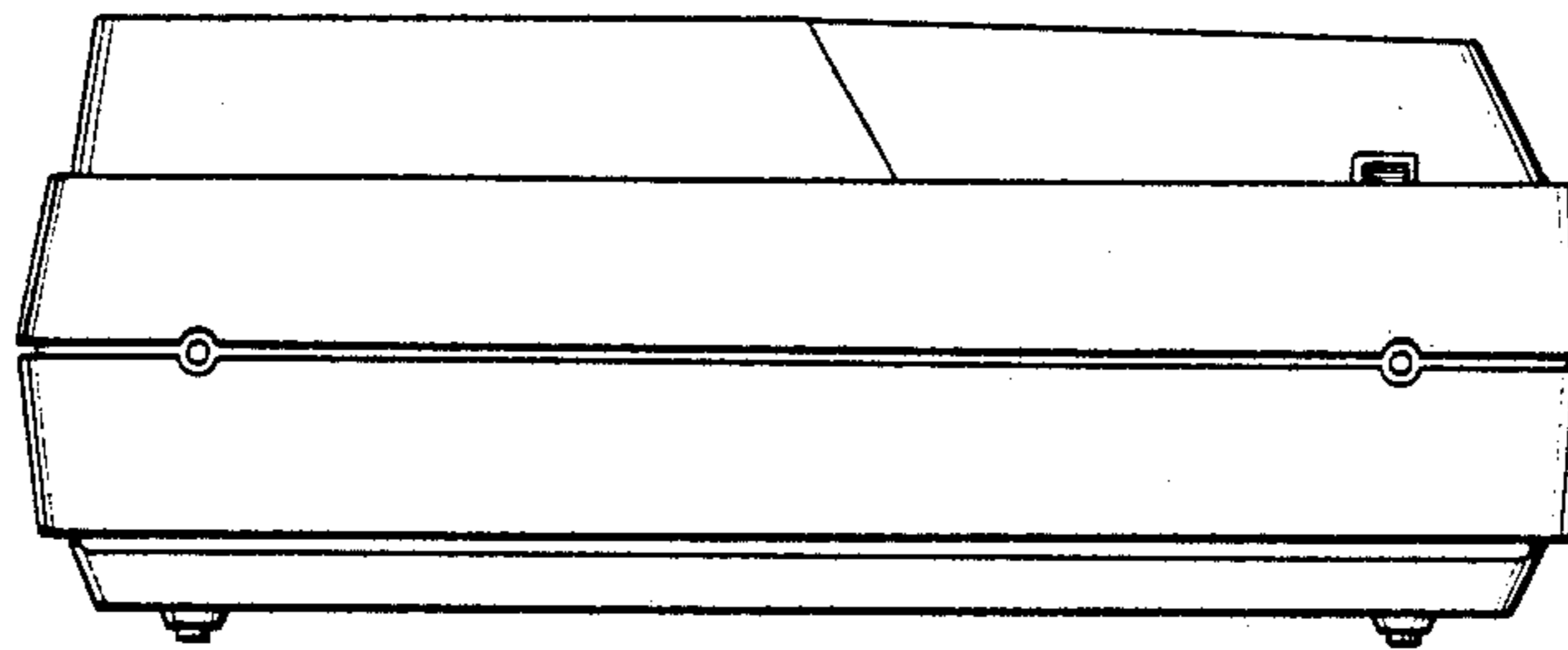

FIG. 5

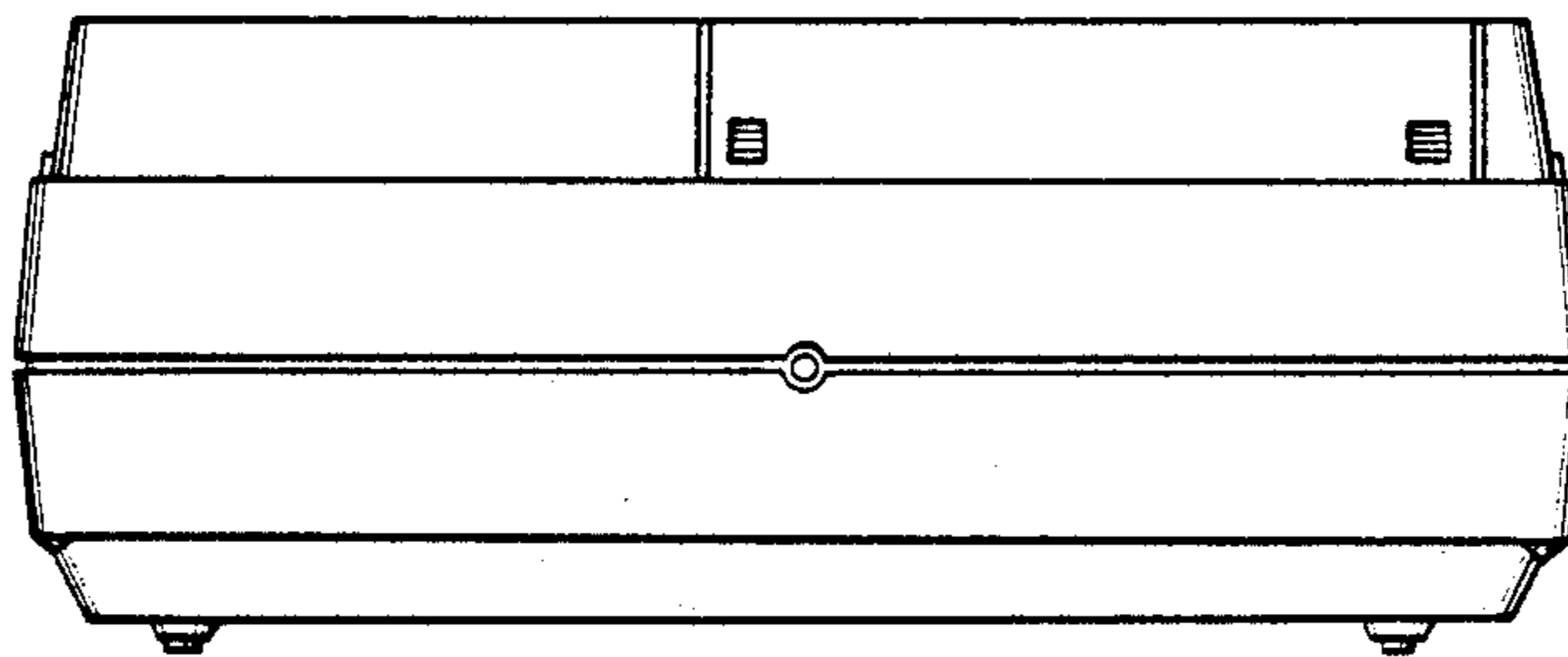

FIG. 6

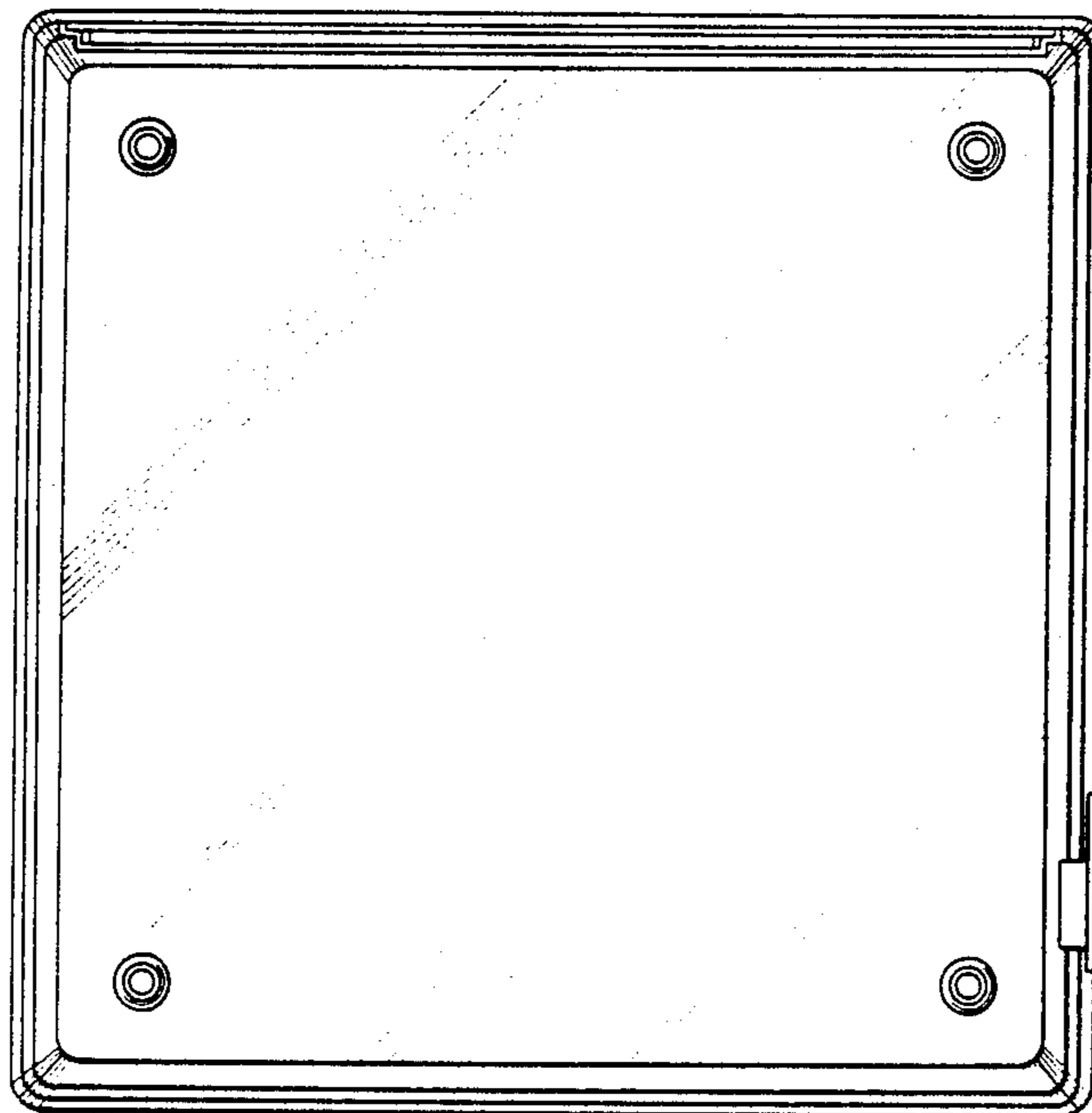

FIG. 7

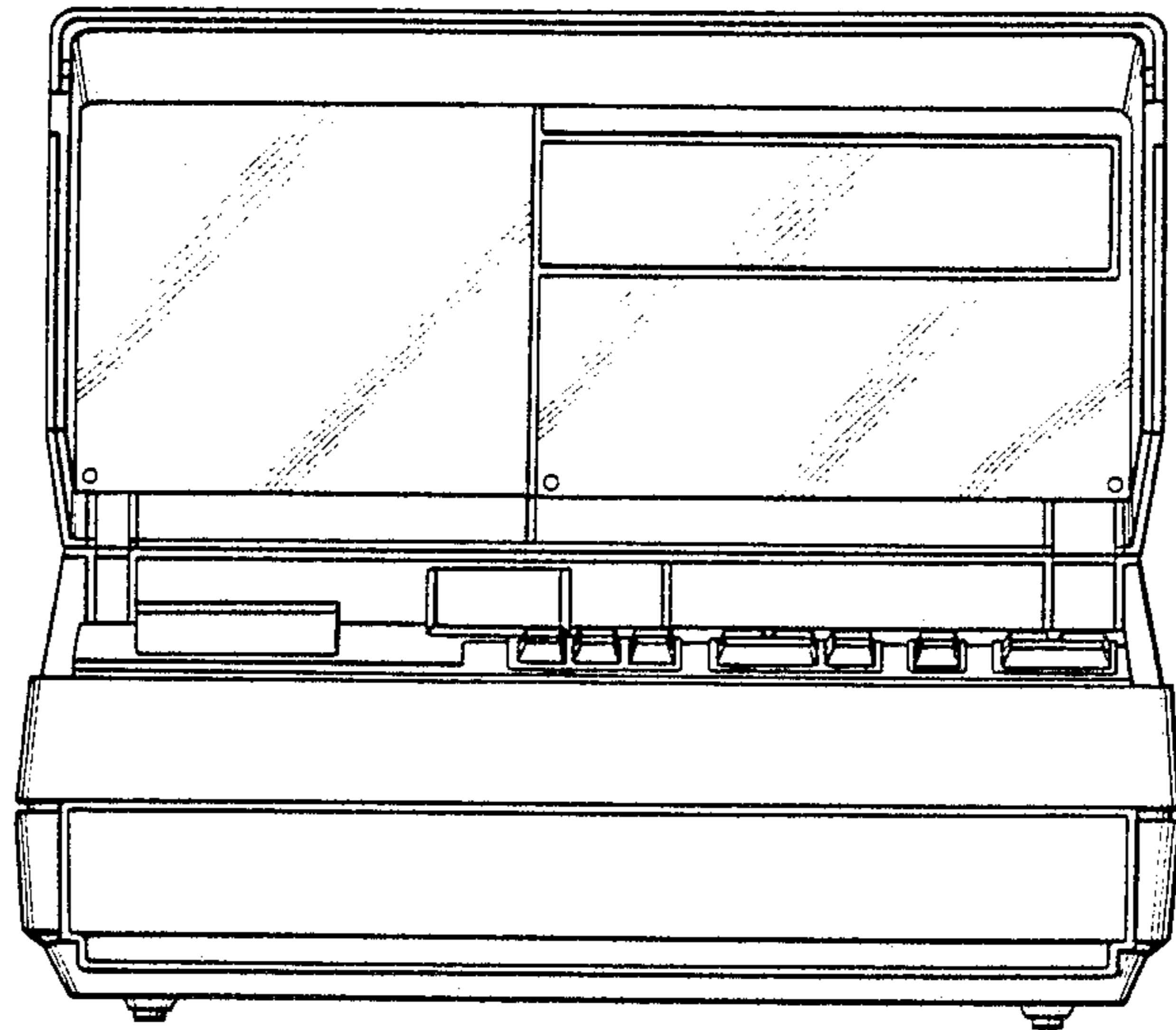

FIG. 8

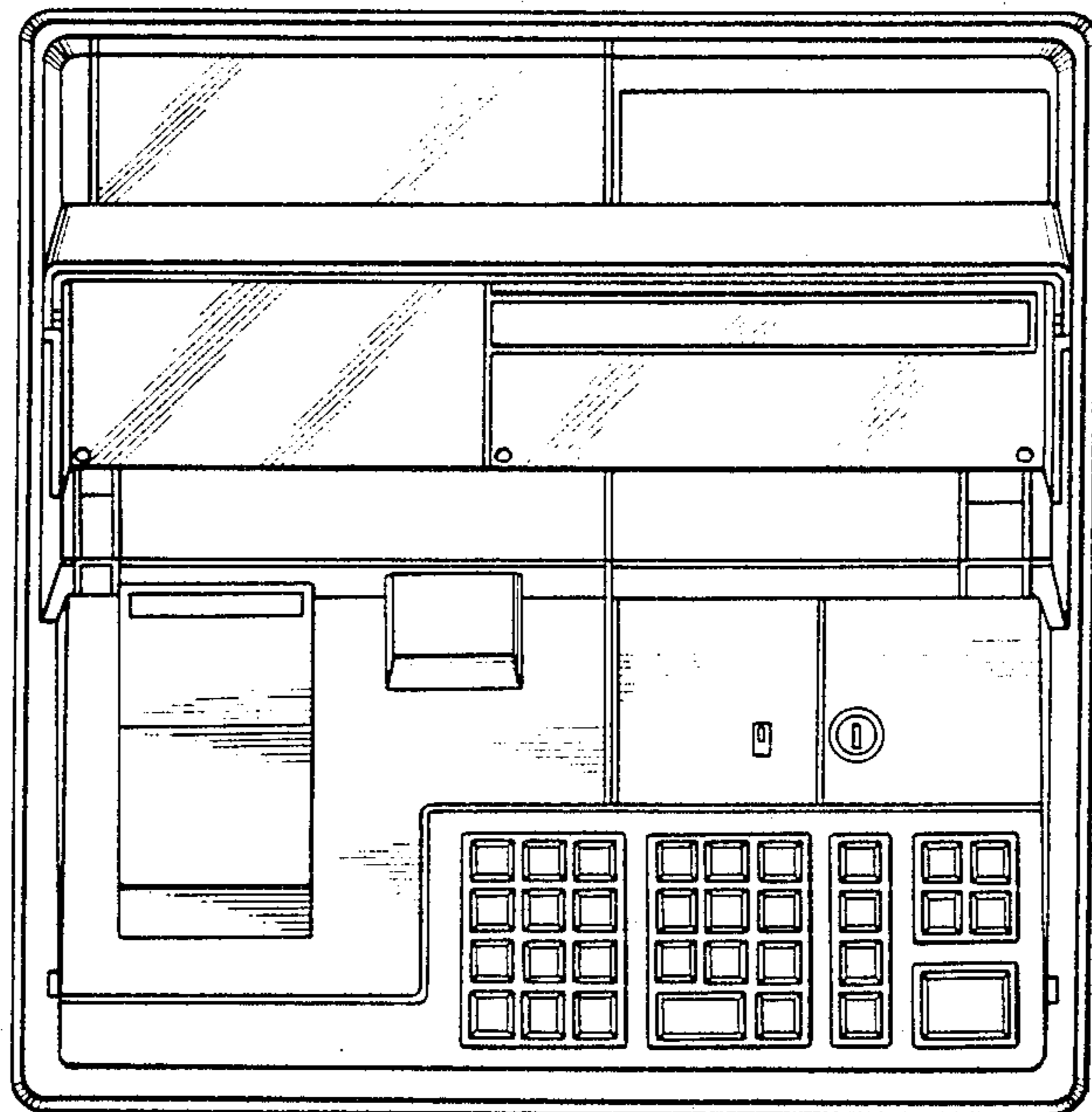

FIG. 9

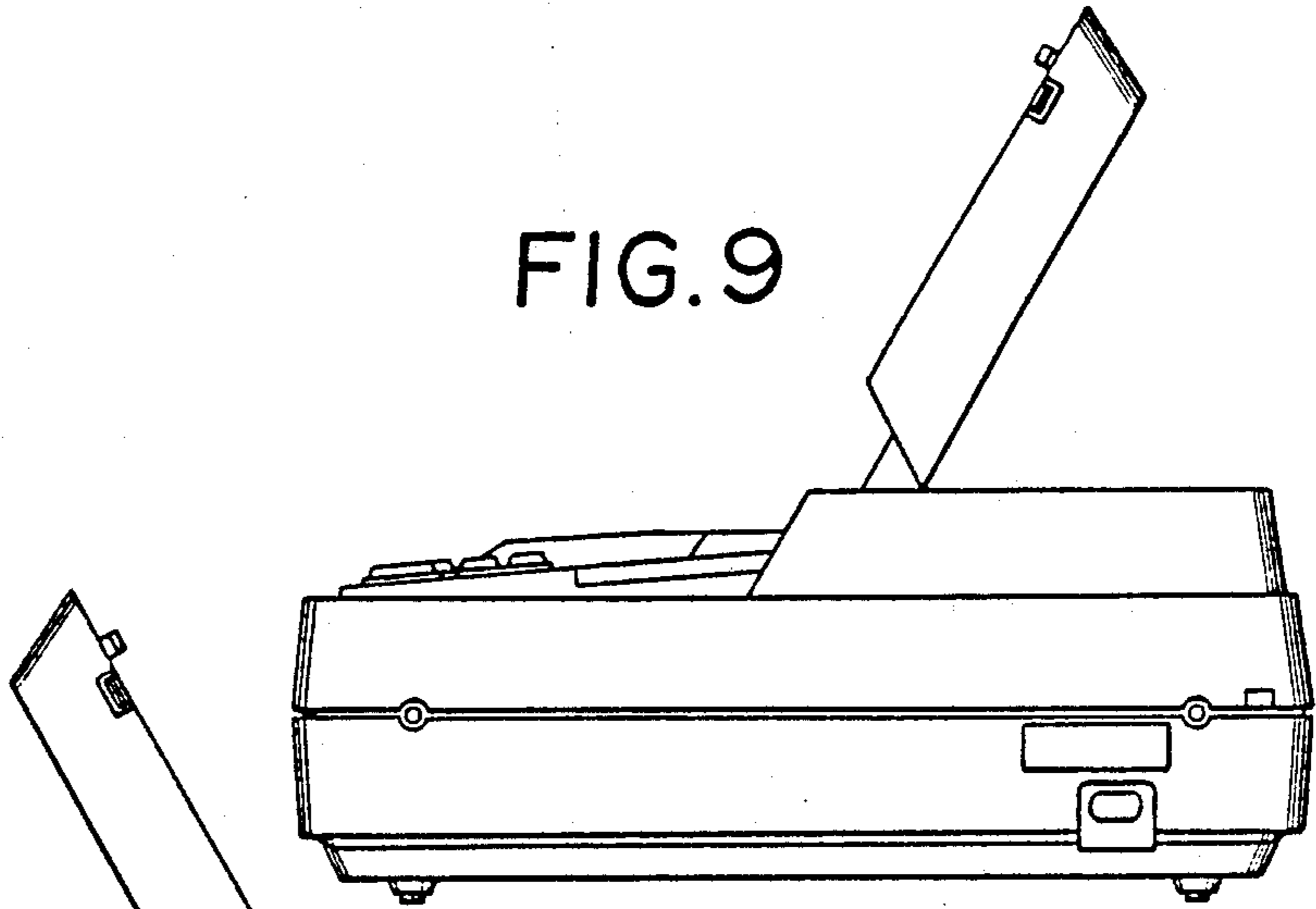

FIG. 10

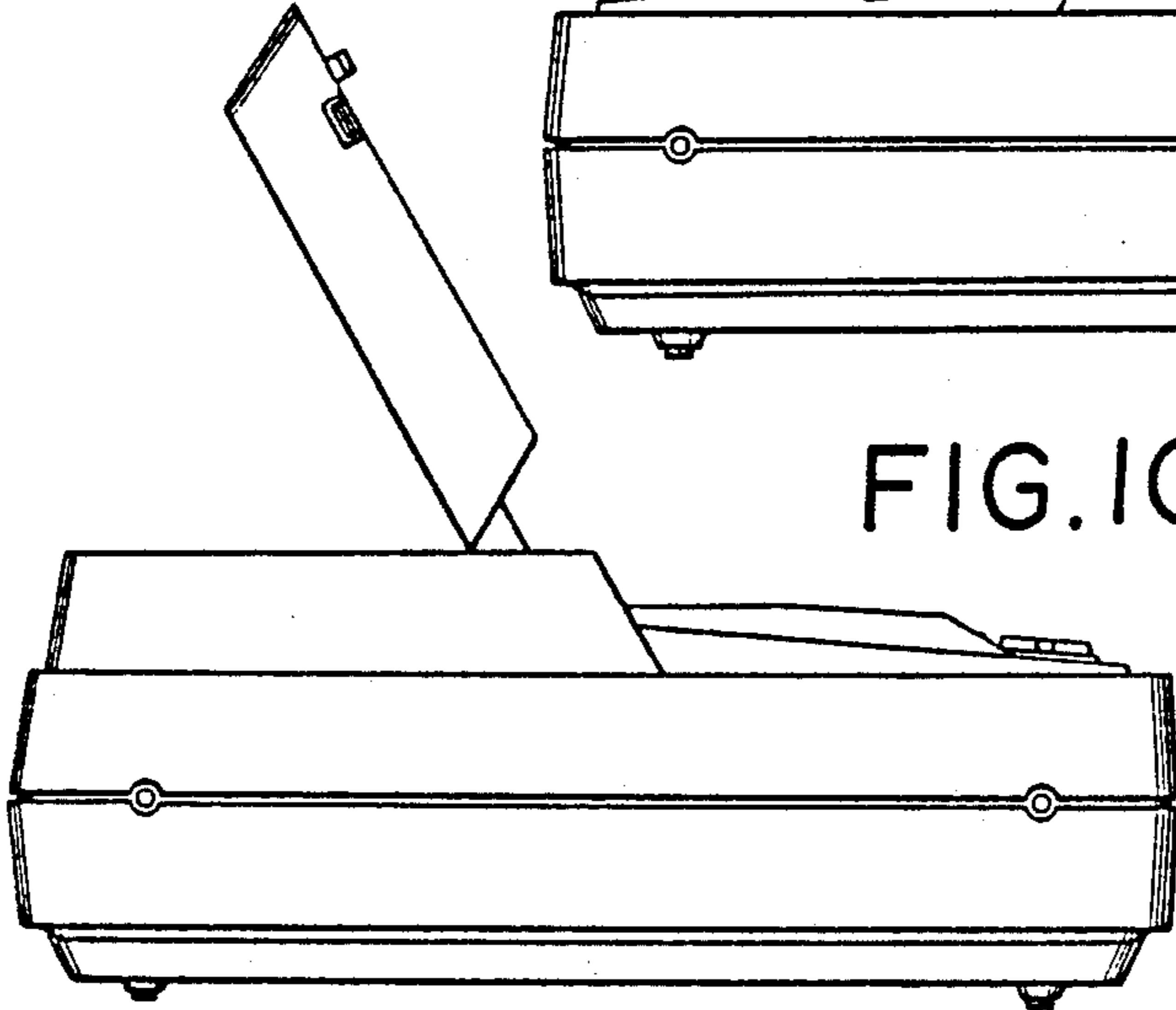

FIG. 11

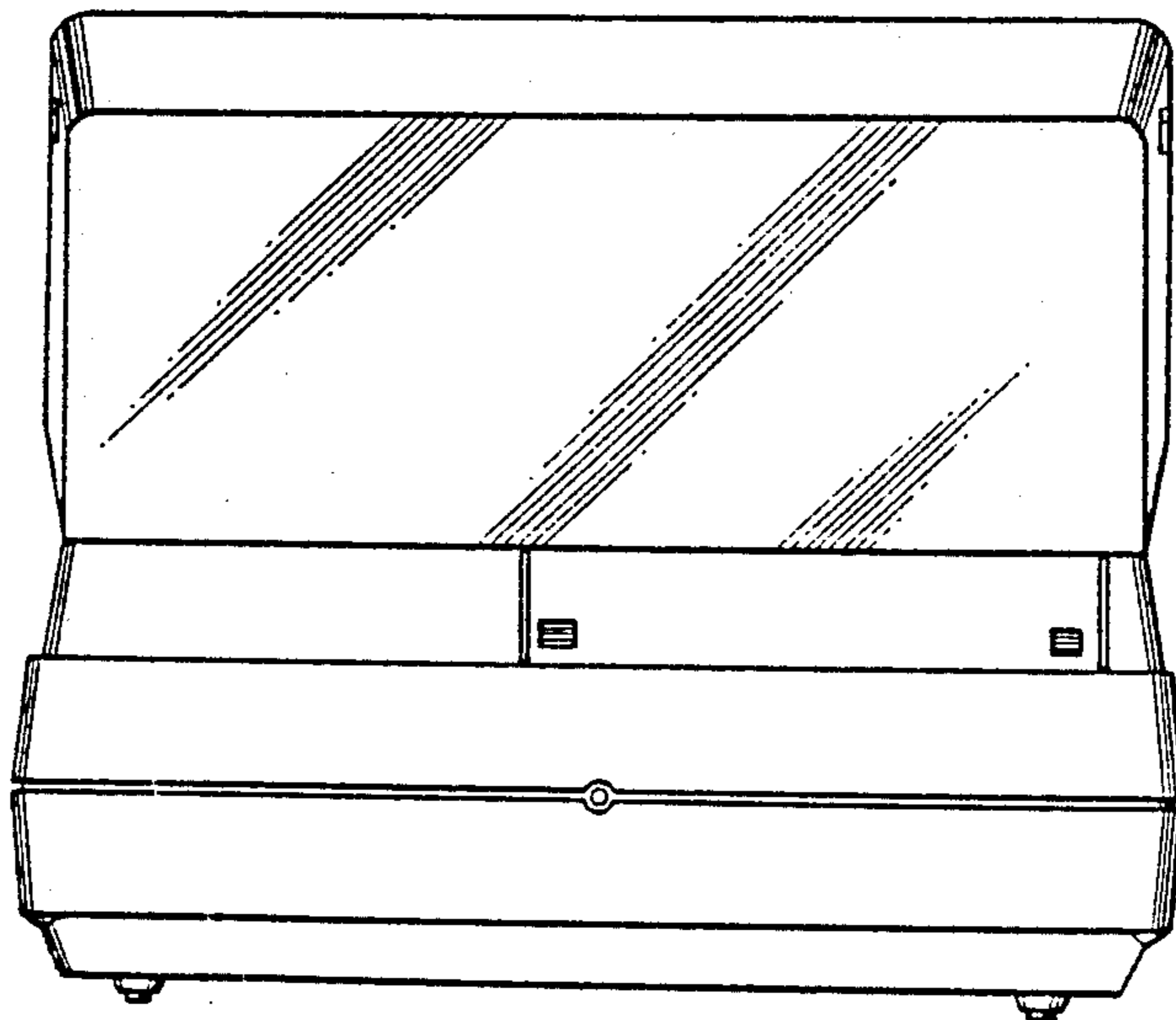

FIG.12

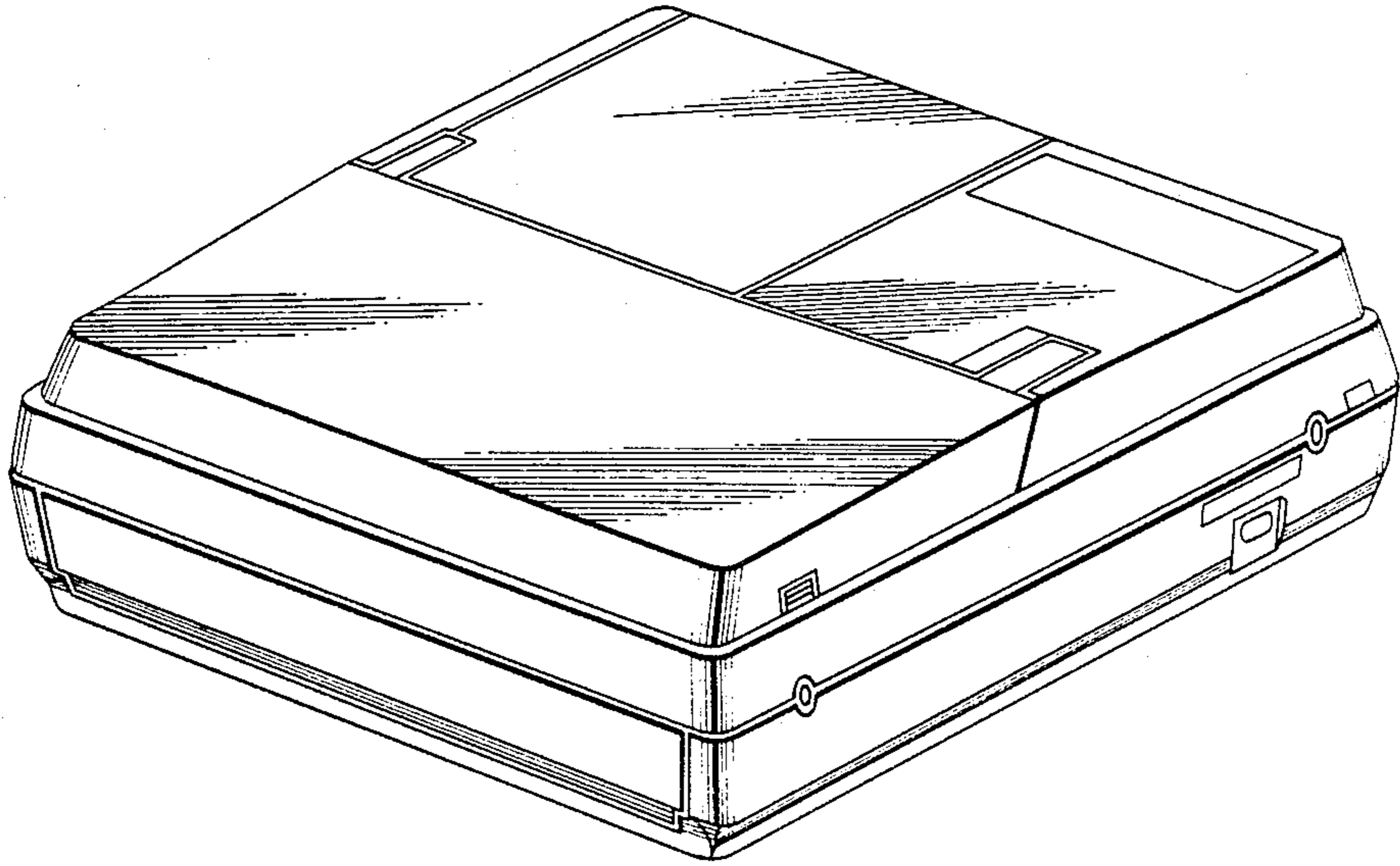

FIG.13

