

[54] 35 MM WATERPROOF CAMERA

D. 284,197 6/1986 Yamamoto et al. .... D16/6

[75] Inventors: Hitoshi Suyama, Kawasaki; Jun Akabane, Tokyo, both of Japan

[73] Assignee: Nippon Kogaku K. K., Tokyo, Japan

[\*\*] Term: 14 Years

[21] Appl. No.: 854,471

[22] Filed: Apr. 16, 1986

[30] Foreign Application Priority Data

Nov. 9, 1985 [JP] Japan ..... 60-47055

[52] U.S. Cl. .... D16/2; D16/6

[58] Field of Search ..... D16/1-10; 354/83-86, 149.11, 152, 173.1, 173.11, 204, 212, 288 A-288 F, 288 M, 288 P, 288 U

[56] References Cited

U.S. PATENT DOCUMENTS

- D. 247,041 1/1978 Fukuda ..... D16/6
- D. 270,840 10/1983 Soda ..... D16/6
- D. 271,207 11/1983 Soda ..... D16/1
- D. 276,050 10/1984 Soda ..... D16/1

OTHER PUBLICATIONS

35 mm Photography, 1/86, p. 57, bottom center Minolta AF-T.

35 mm Photography, 7/85, p. 26, right side-Ricoh AF-40.

Primary Examiner—Bernard Ansher  
Assistant Examiner—Theodore M. Shooman  
Attorney, Agent, or Firm—Shapiro and Shapiro

[57] CLAIM

The ornamental design for a 35 mm waterproof camera, as shown and described.

DESCRIPTION

FIG. 1 is a top, front and left side perspective view of a 35 mm waterproof camera showing our new design; FIG. 2 is a top plan view thereof; FIG. 3 is a bottom view thereof; FIG. 4 is a right side elevational view thereof; FIG. 5 is a left side elevational view thereof; FIG. 6 is a front elevational view thereof; and FIG. 7 is a rear elevational view thereof.

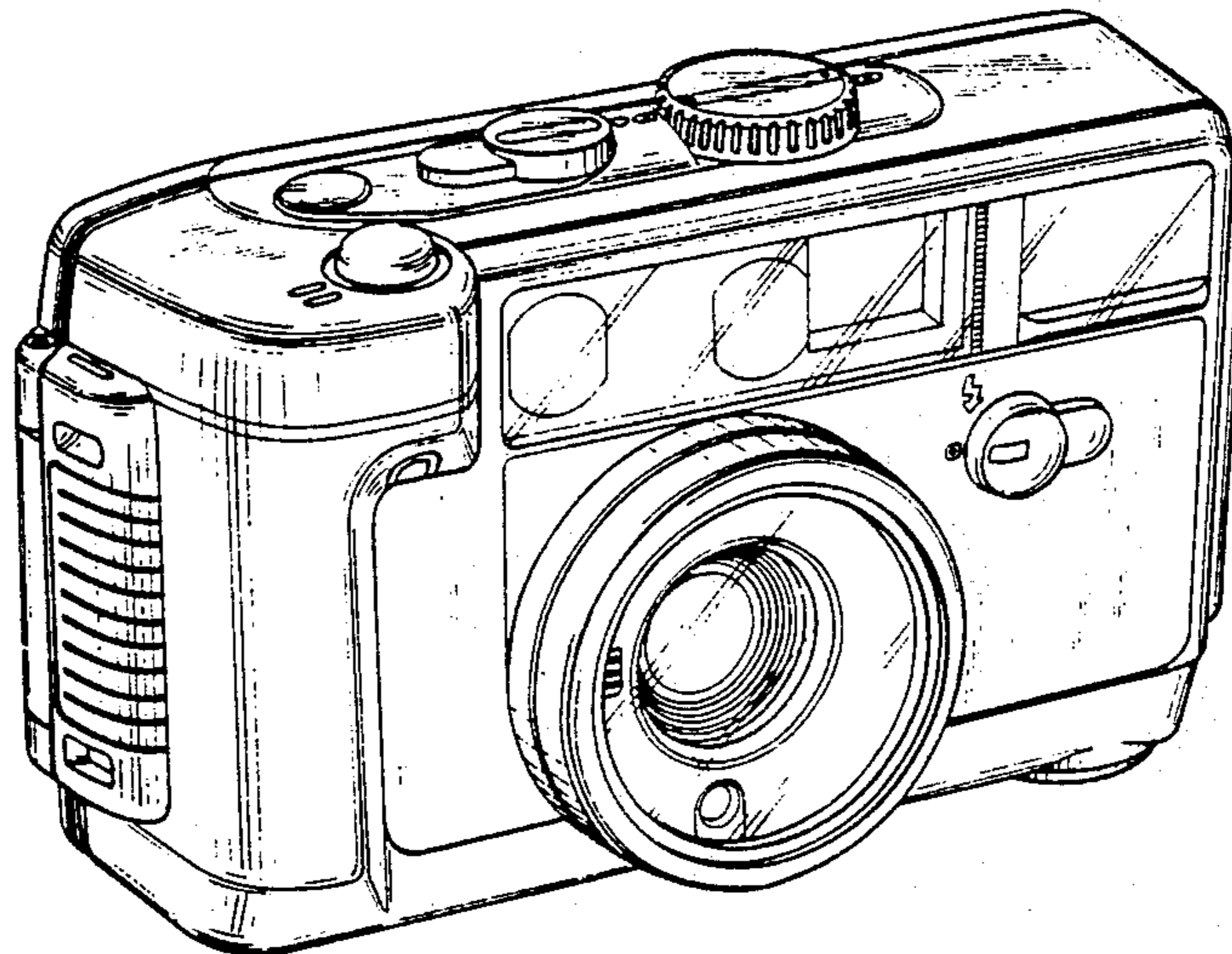

FIG. 1

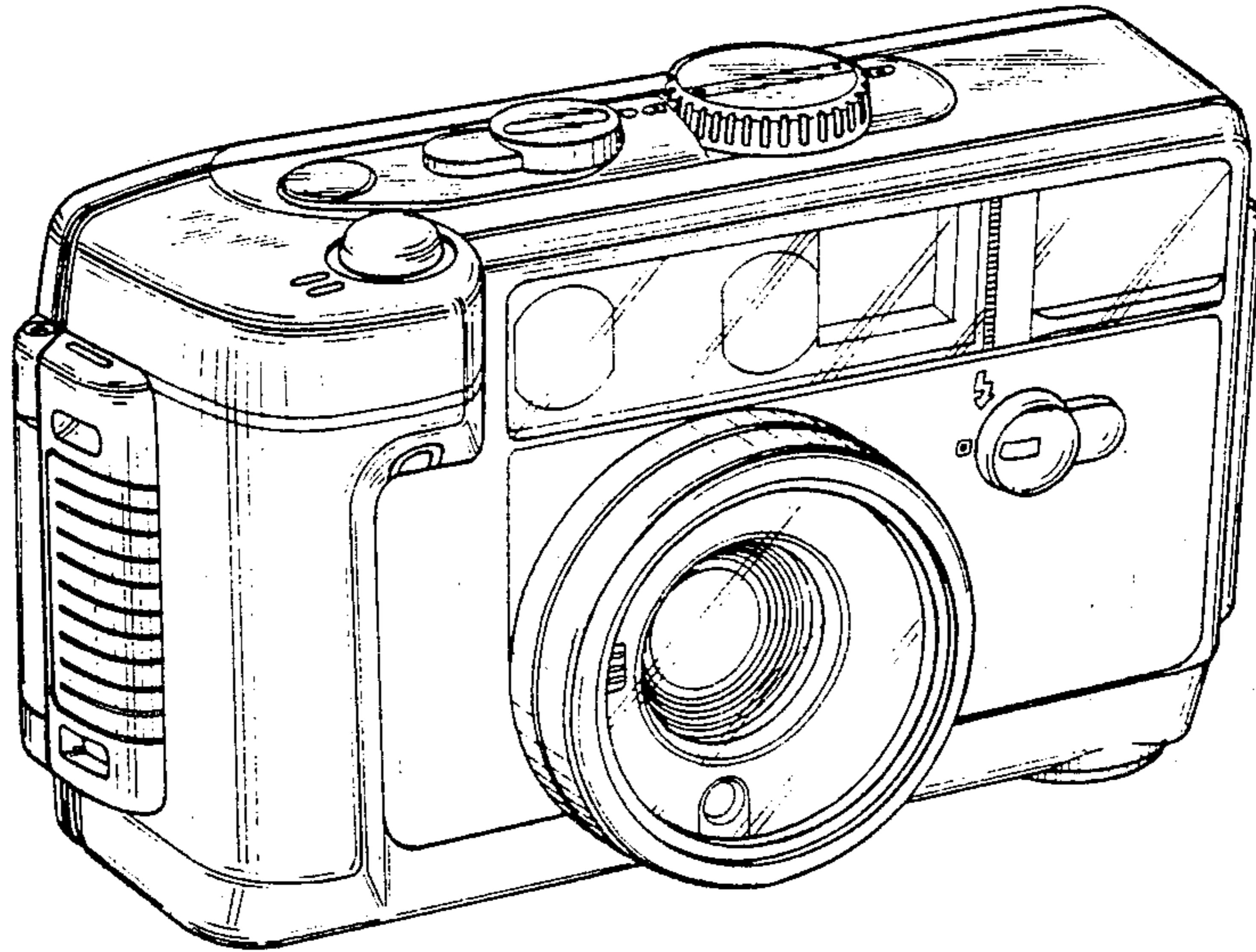

FIG. 2

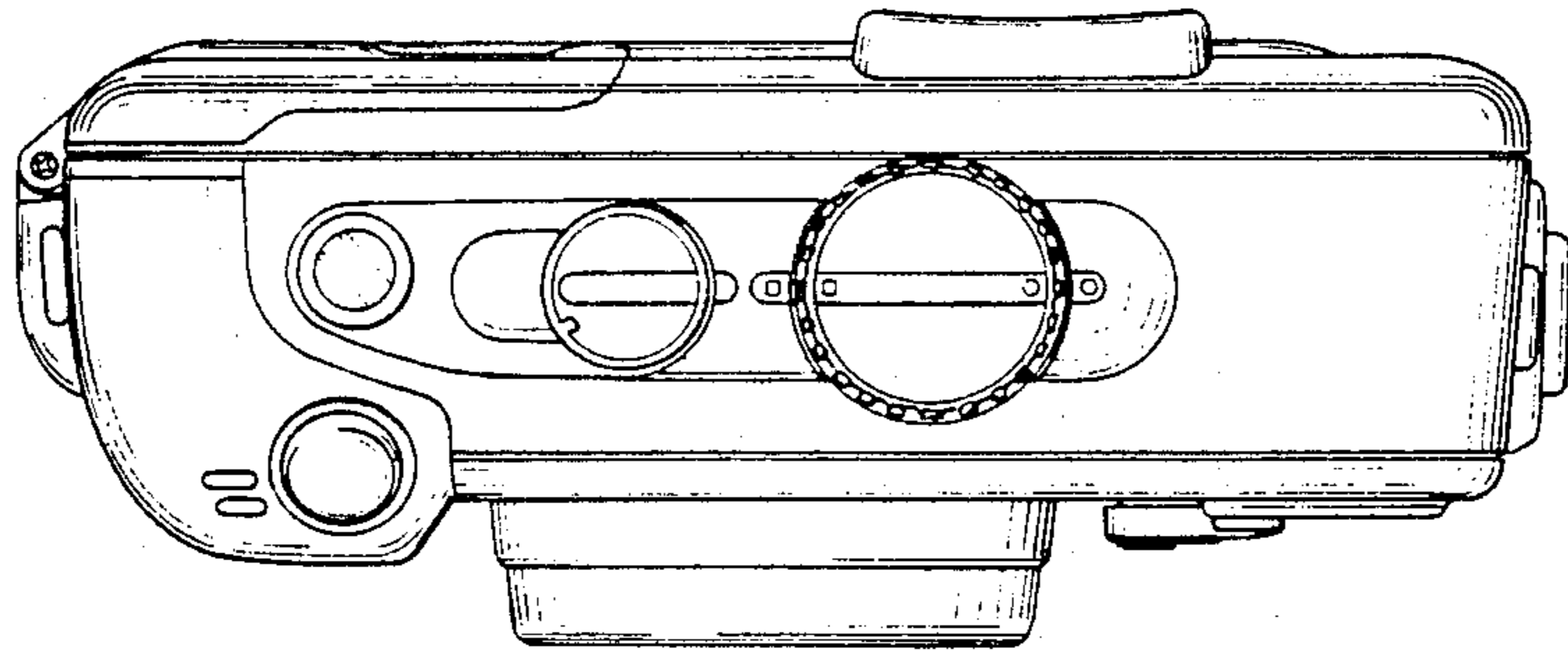

FIG. 3

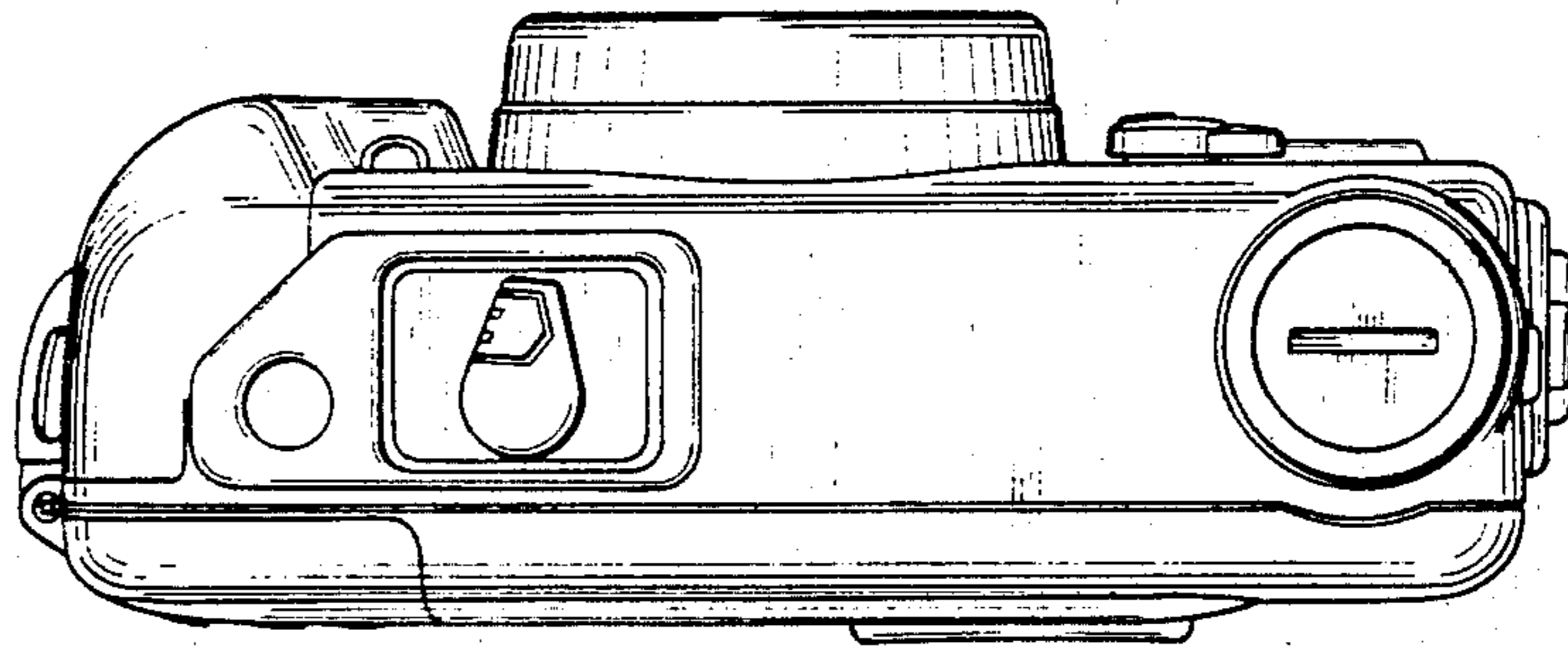

FIG. 4

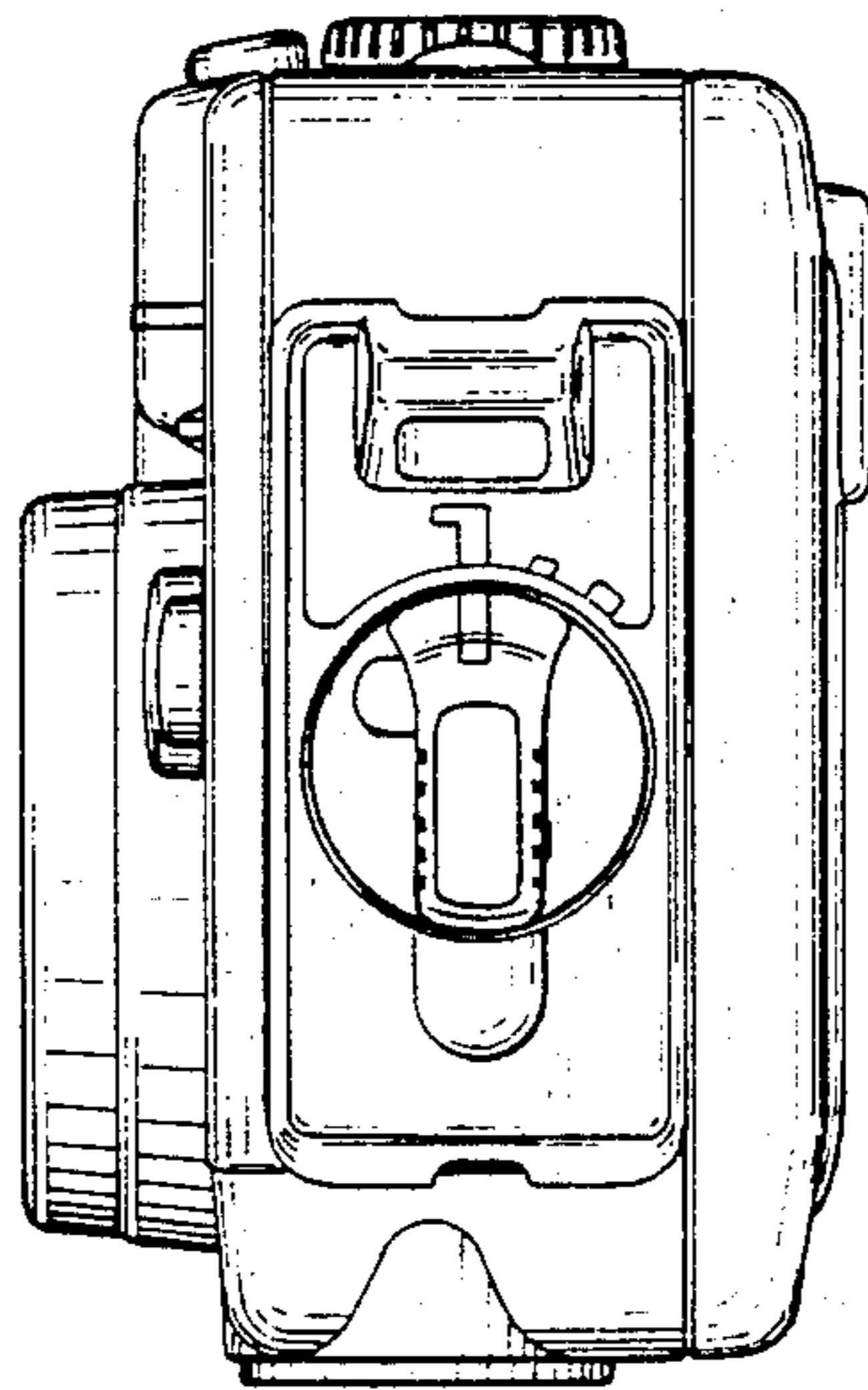

FIG. 5

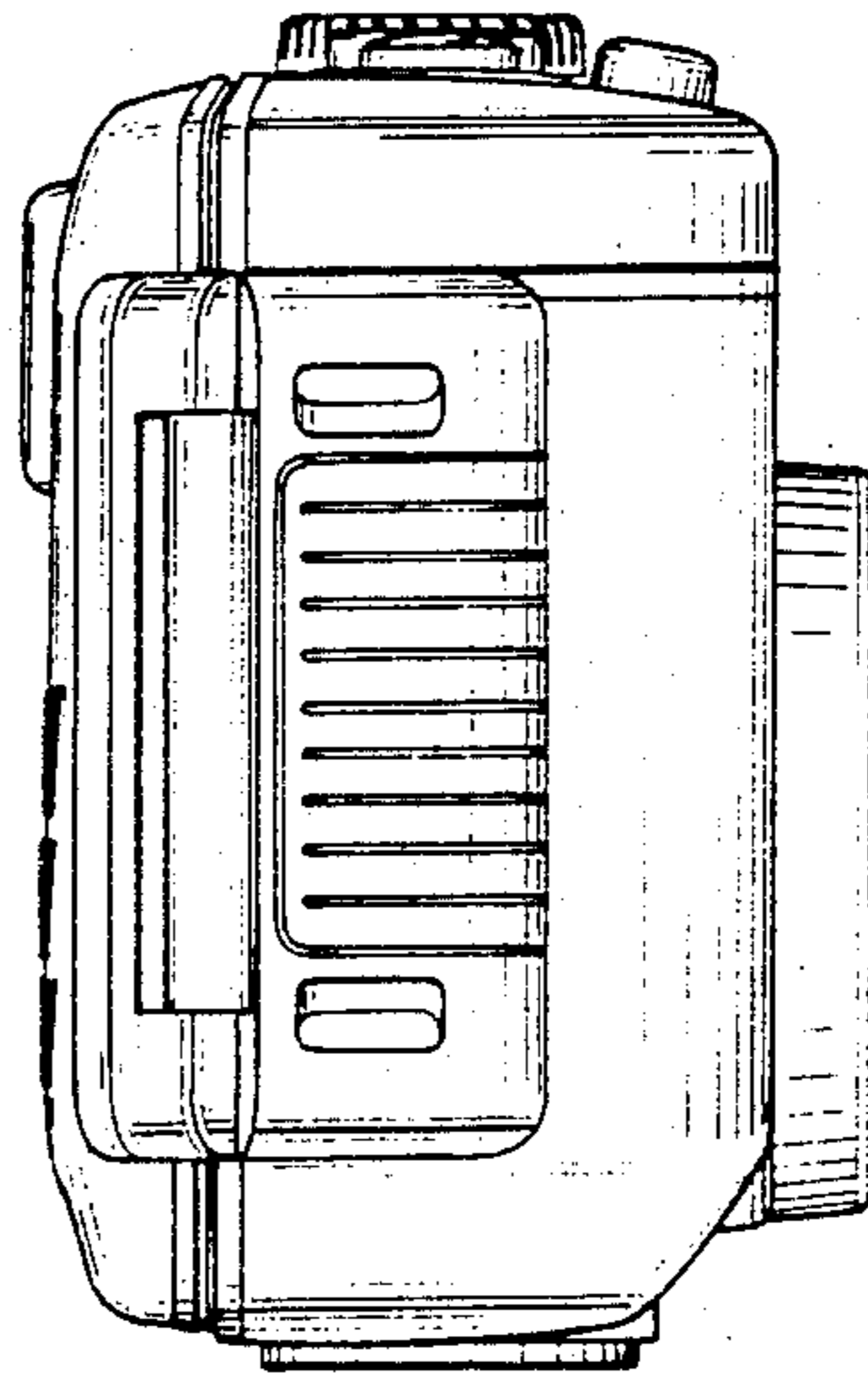

FIG. 6

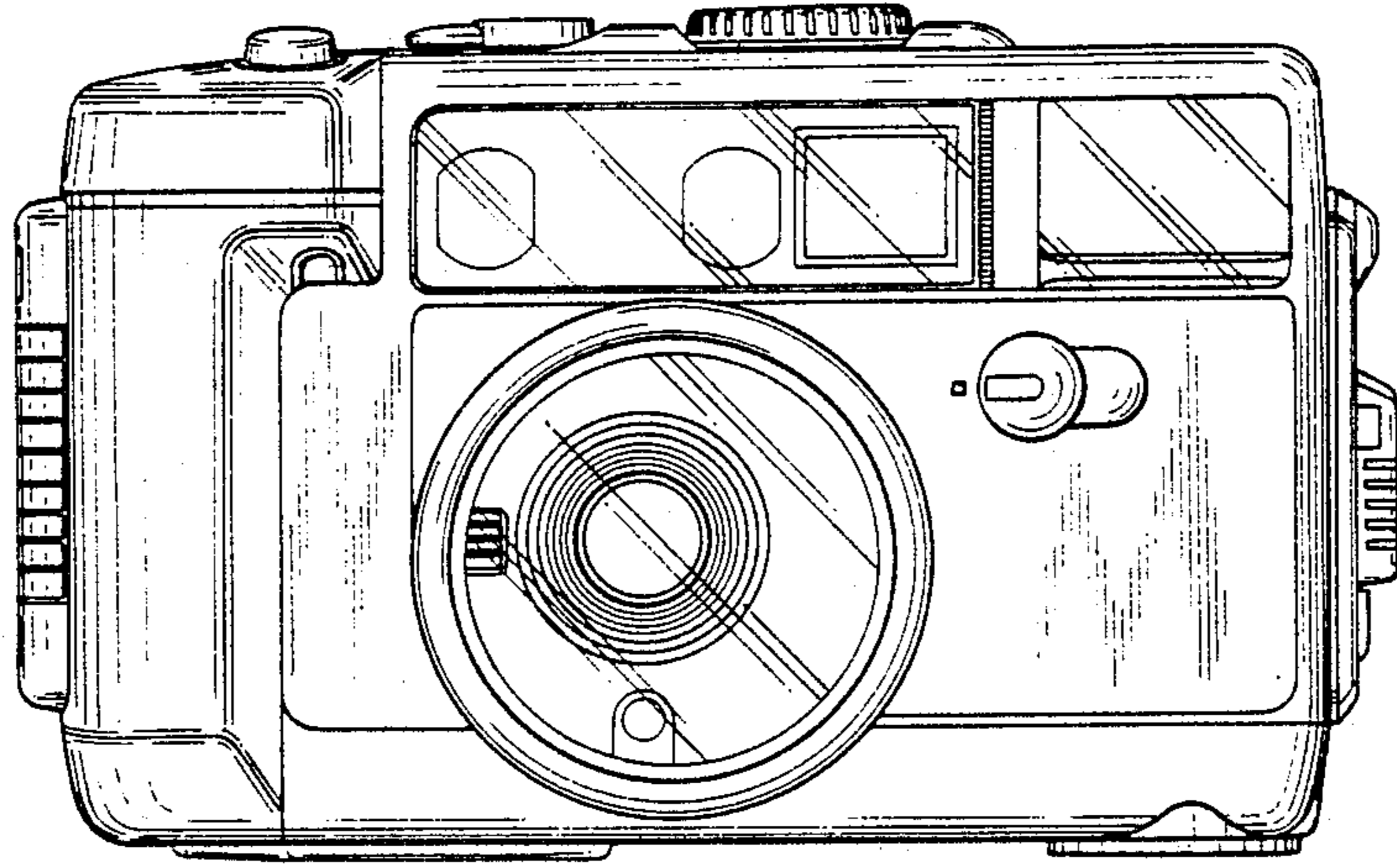

FIG. 7

