

[54] **COAT-STAND**

[75] **Inventor: Winfried Scholl, Düsseldorf, Fed. Rep. of Germany**

[73] **Assignee: Fa. Hewi Heinrich GmbH, Arolsen, Fed. Rep. of Germany**

[**] **Term: 14 Years**

[21] **Appl. No.: 771,051**

[22] **Filed: Aug. 30, 1985**

[30] **Foreign Application Priority Data**

Mar. 1, 1985 [DE] Fed. Rep. of Germany M 246
[52] **U.S. Cl. D6/415; D6/457**
[58] **Field of Search D6/411, 412, 413, 415, D6/455, 456, 457, 458, 459, 460, 461; 211/13, 30, 33, 37**

[56] **References Cited**

U.S. PATENT DOCUMENTS

D. 47,575 7/1915 Bamberger D6/457
D. 222,567 11/1971 Cohen D6/458 X
D. 225,703 1/1973 Miller, Jr. D6/458

D. 232,679 9/1974 Weiss D6/458
D. 247,402 3/1978 Cohen D6/414
D. 280,957 10/1985 Meier D6/455
D. 288,508 3/1987 Toyama D6/415

Primary Examiner—Carmen H. Vales

[57] **CLAIM**

The ornamental design for a coat stand, substantially as shown and described.

DESCRIPTION

FIG. 1 is a perspective view of a coat stand showing my new design;
FIG. 2 is a bottom perspective view thereof;
FIG. 3 is a bottom plan view thereof;
FIG. 4 is a front elevational view thereof;
FIG. 5 is a rear elevational view thereof;
FIG. 6 is a top plan view thereof;
FIG. 7 is a top perspective view of a modified embodiment of the coat stand shown in FIG. 1;
FIG. 8 is a bottom perspective view thereof;
FIG. 9 is a bottom plan view thereof;
FIG. 10 is a front elevational view thereof;
FIG. 11 is a left side elevational view thereof; and
FIG. 12 is a top plan view thereof.

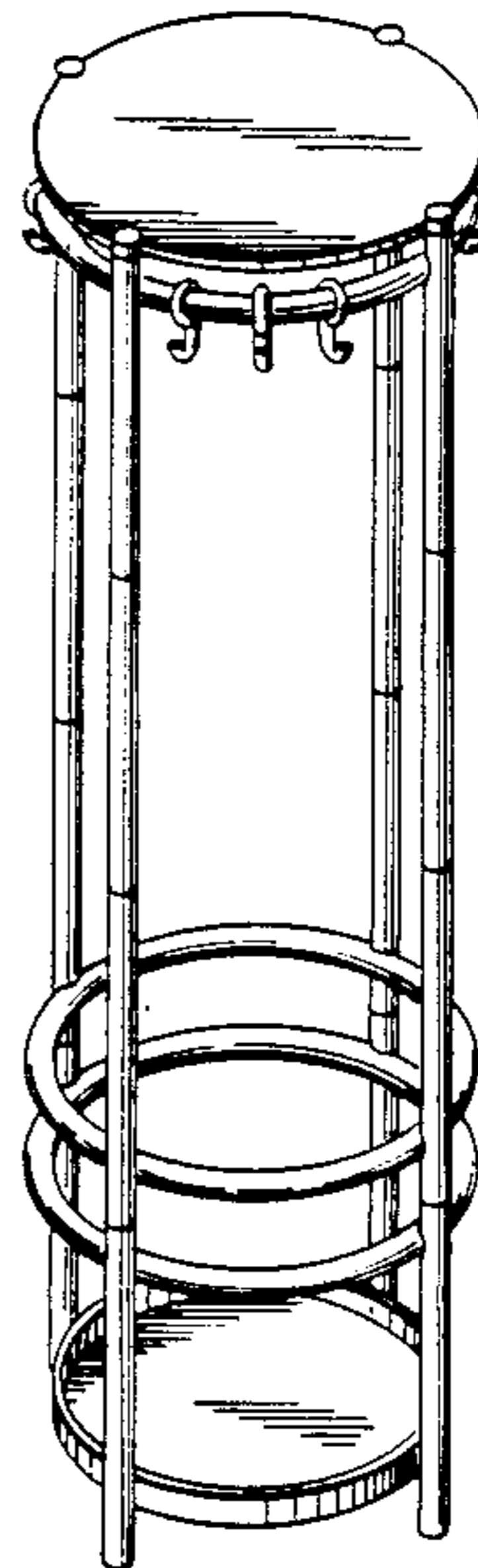
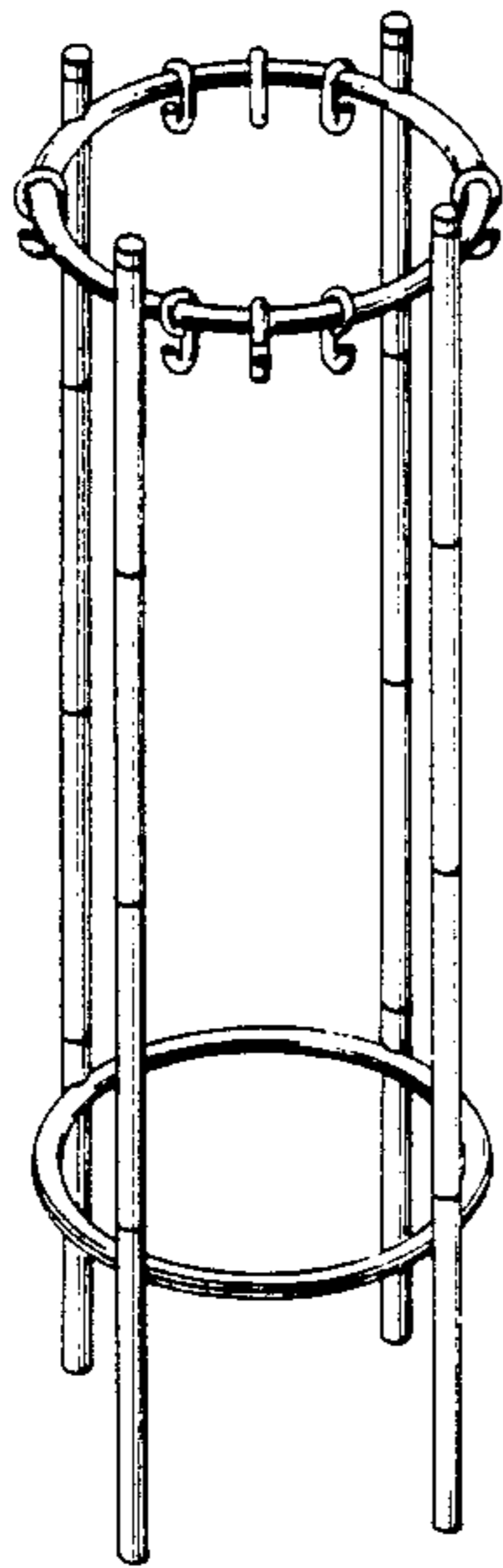

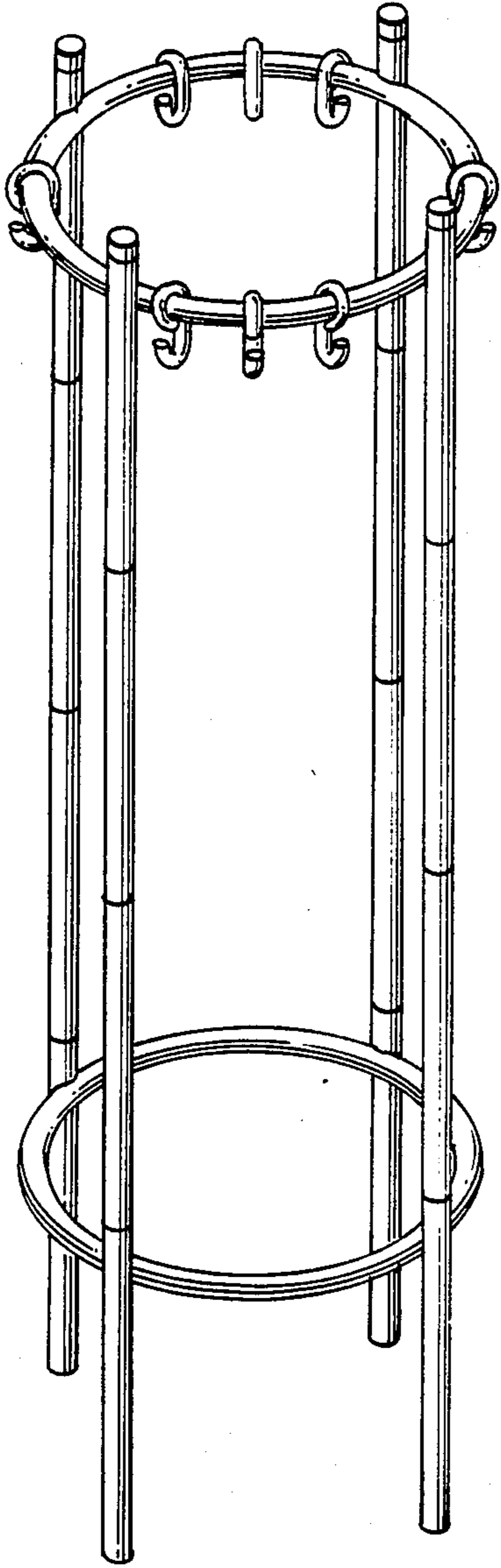

FIG. 1

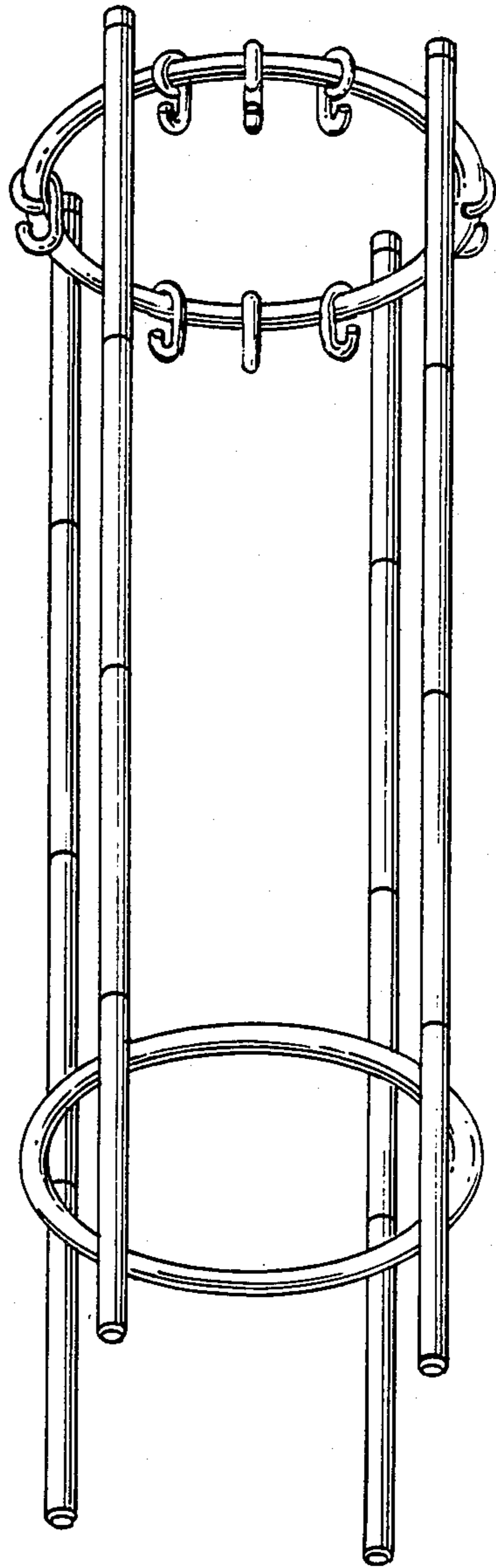

FIG. 2

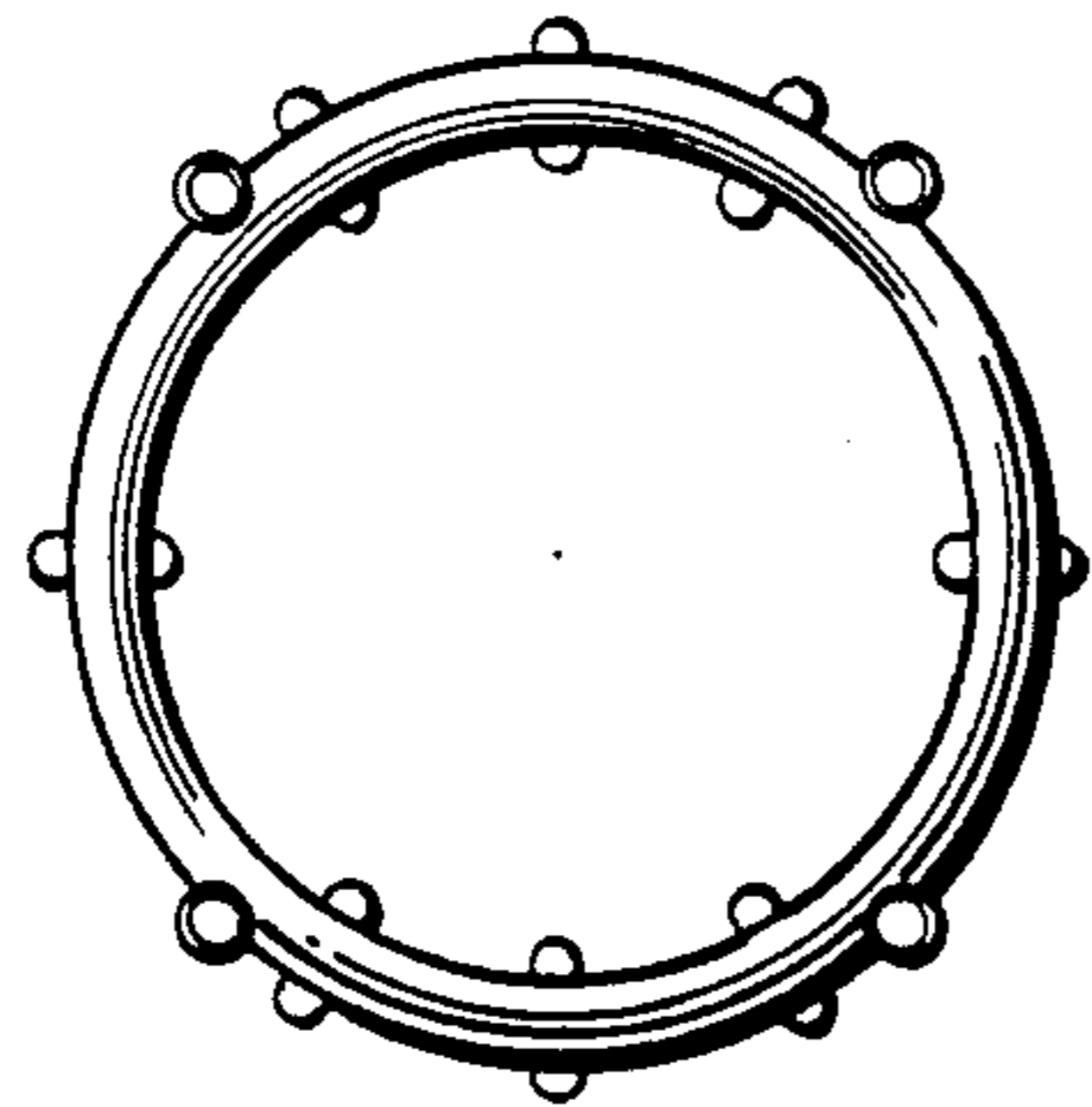

FIG. 3

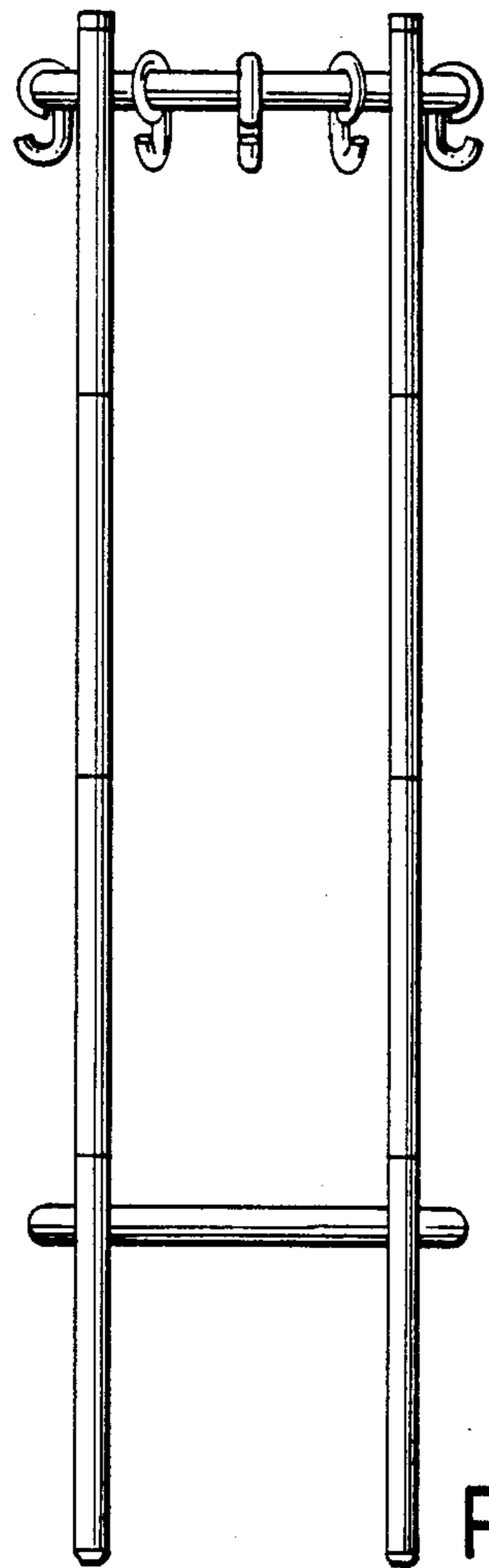

FIG. 4

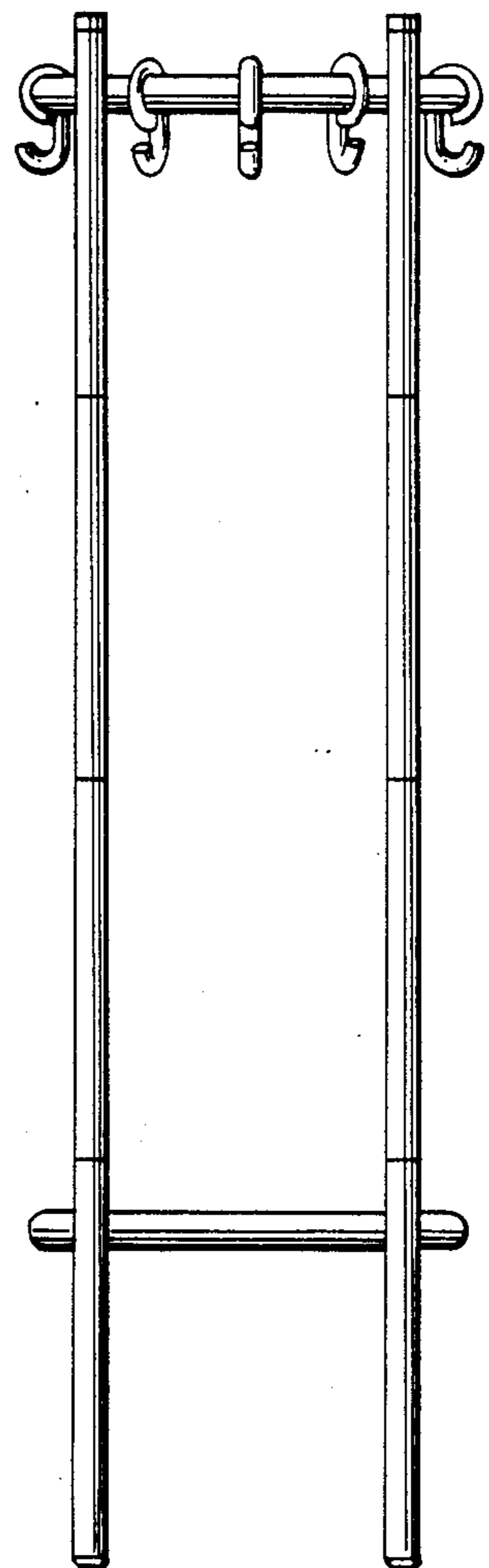

FIG. 5

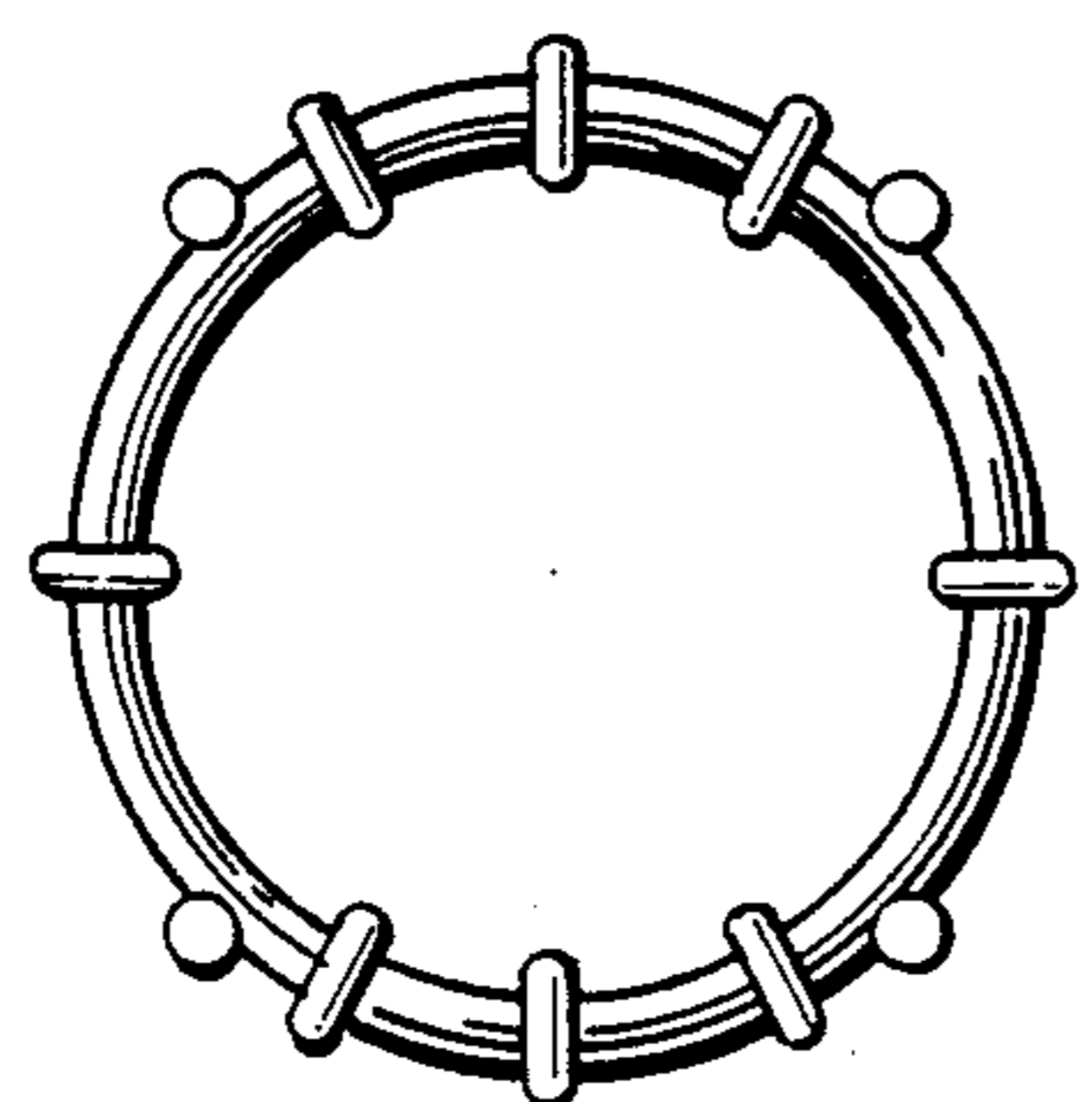

FIG. 6

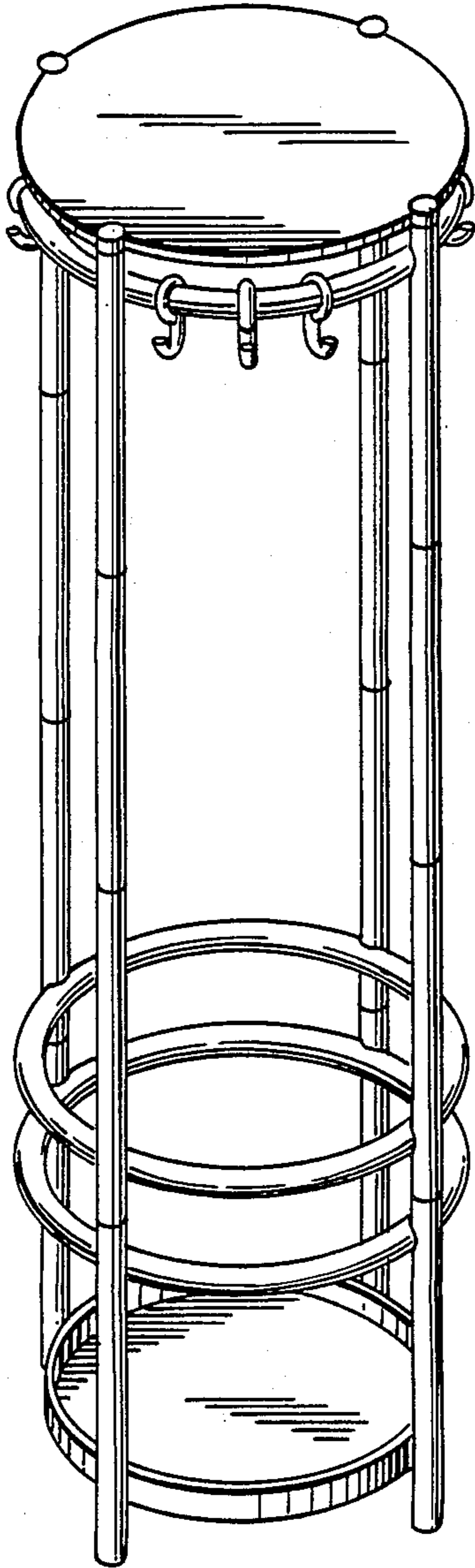

FIG. 7

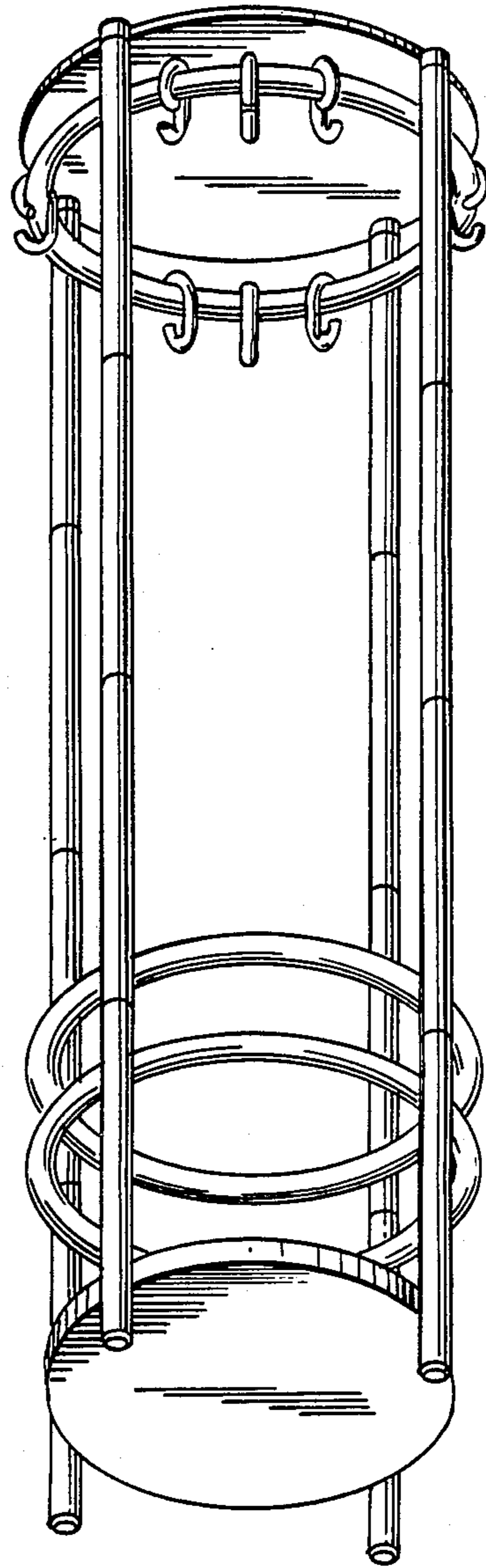

FIG. 8

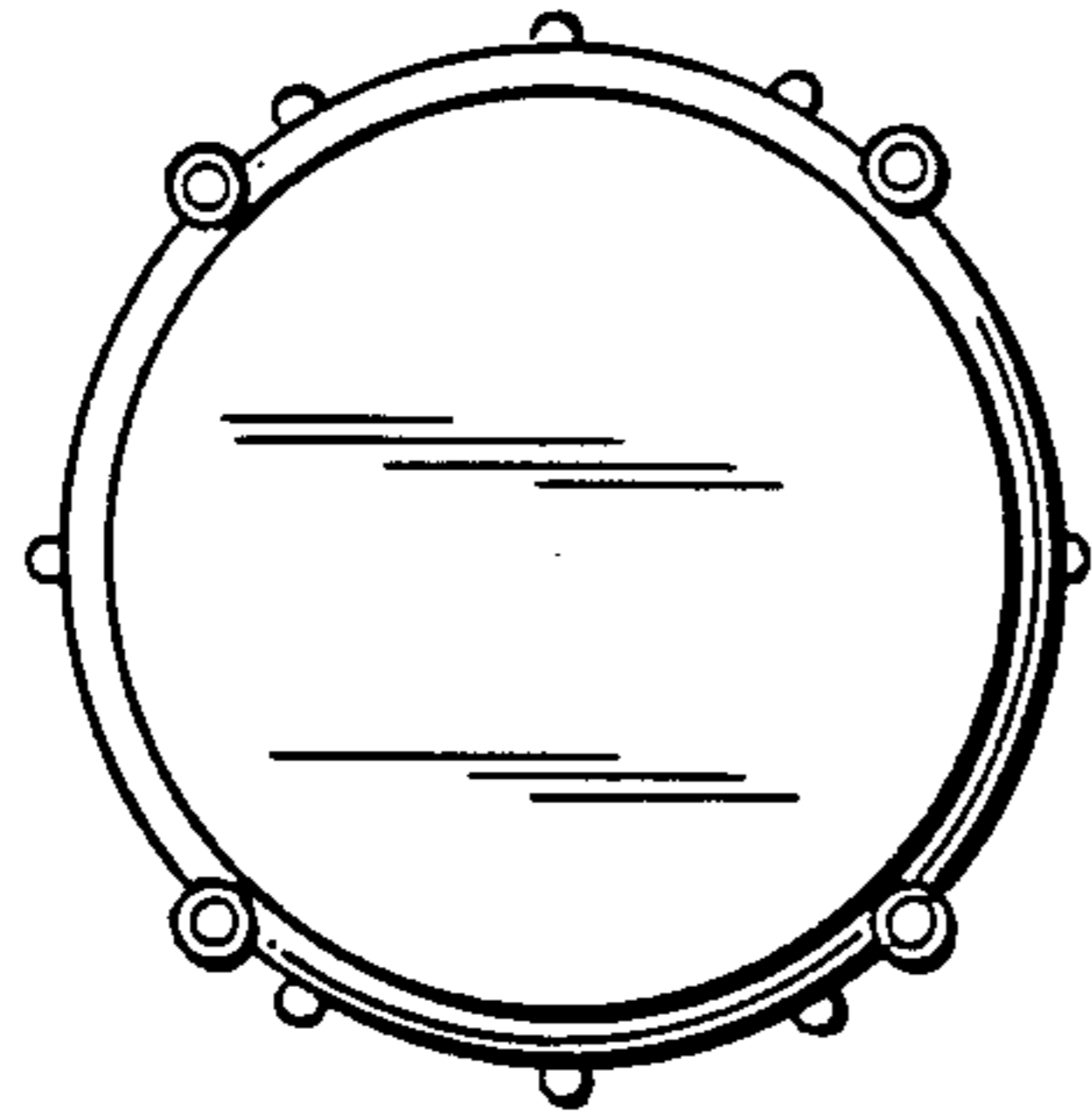

FIG. 9

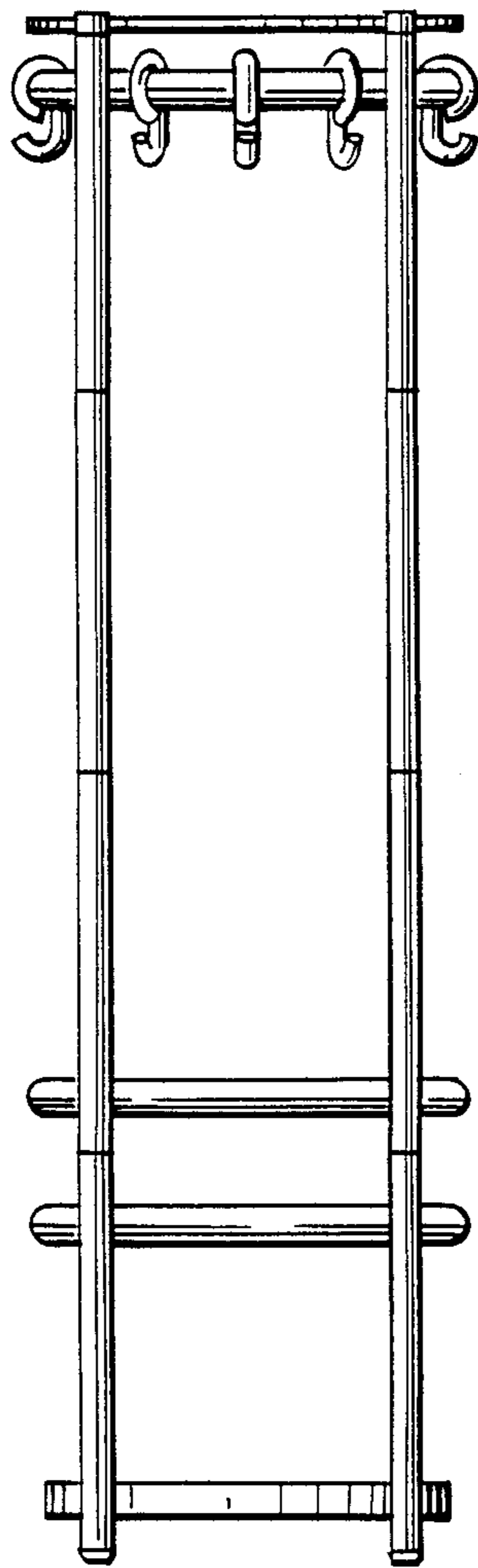

FIG. 10

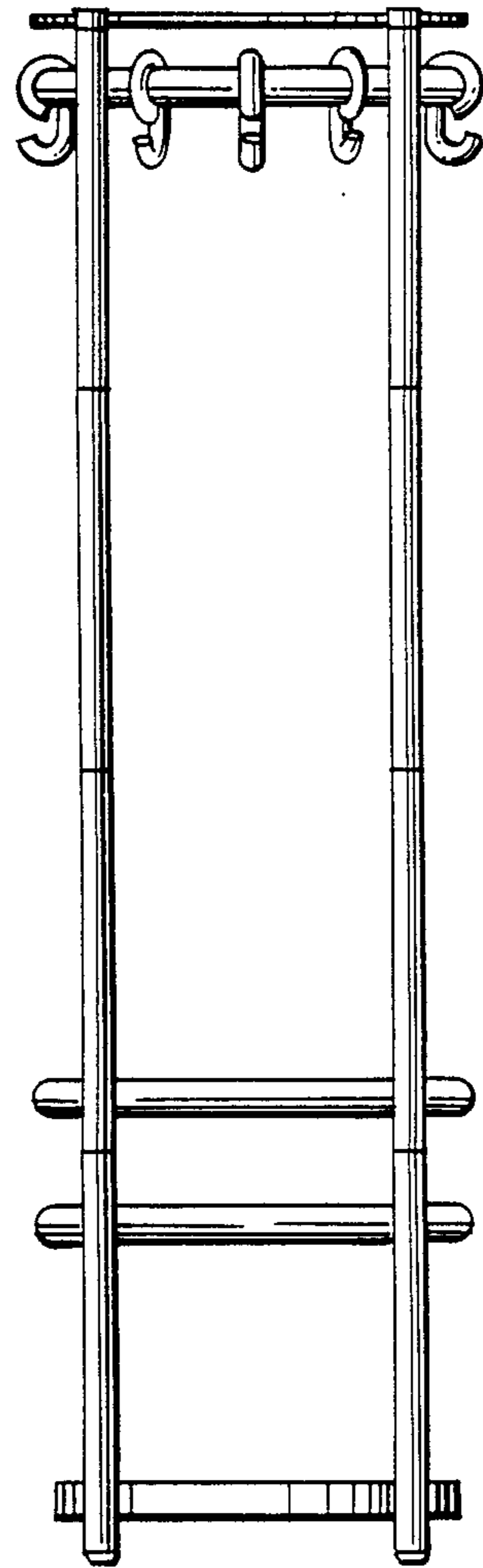

FIG. 11

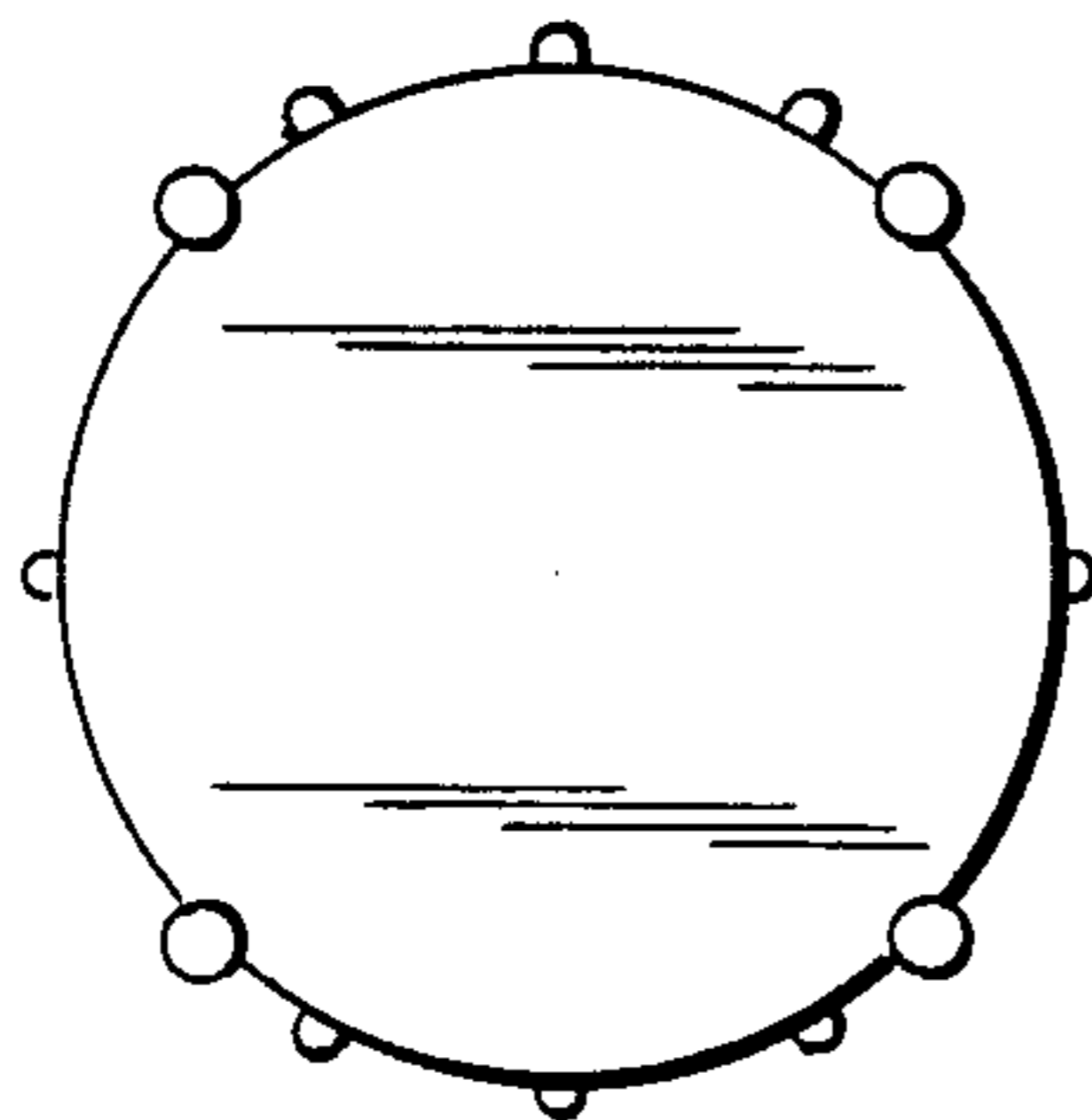

FIG. 12