

[54] CAMERA CASE OR SIMILAR ARTICLE

[75] Inventors: John R. Peterson, Brooklyn; James M. Ryan, New York, both of N.Y.; George D. Whiteside, Lexington; Richard M. Wingate, Medway, both of Mass.

[73] Assignee: Polaroid Corporation, Cambridge, Mass.

[**] Term: 14 Years

[21] Appl. No.: 870,734

[22] Filed: Jun. 4, 1986

[52] U.S. Cl. D16/10; D16/5

[58] Field of Search D16/1-10; 354/83-86, 149.11, 152, 173.1, 173.11, 204, 212, 288 A-288 F, 288 M, 288 P, 288 U

[56] References Cited

U.S. PATENT DOCUMENTS

- D. 151,804 11/1948 Wolff D16/1
- D. 279,574 7/1985 Conner et al. D16/5
- 3,753,392 8/1973 Land 354/174 X
- 4,545,661 10/1985 Hamaguchi et al. 354/86

FOREIGN PATENT DOCUMENTS

0178338 10/1983 Japan 354/83

OTHER PUBLICATIONS

U.S. patent application Ser. No. 747,900, filed Jun. 24, 1985 by B. K. Johnson, et al., for folding photographic apparatus or similar article.

U.S. patent application Ser. No. 748,225, filed Jun. 24, 1985 by B. K. Johnson, et al., for folded photographic apparatus or similar article.

Primary Examiner—Bernard Ansher

Assistant Examiner—Theodore M. Shooman

Attorney, Agent, or Firm—David R. Thornton

[57] CLAIM

The ornamental design for a camera case or similar article, as shown.

DESCRIPTION

FIG. 1 is a top, front and right side perspective view of a camera case or similar article showing our new design; FIG. 2 is a front elevational view thereof; FIG. 3 is a rear elevational view thereof; FIG. 4 is a right side elevational view thereof; FIG. 5 is a left side elevational view thereof; FIG. 6 is a top plan view thereof; FIG. 7 is a bottom plan view thereof.

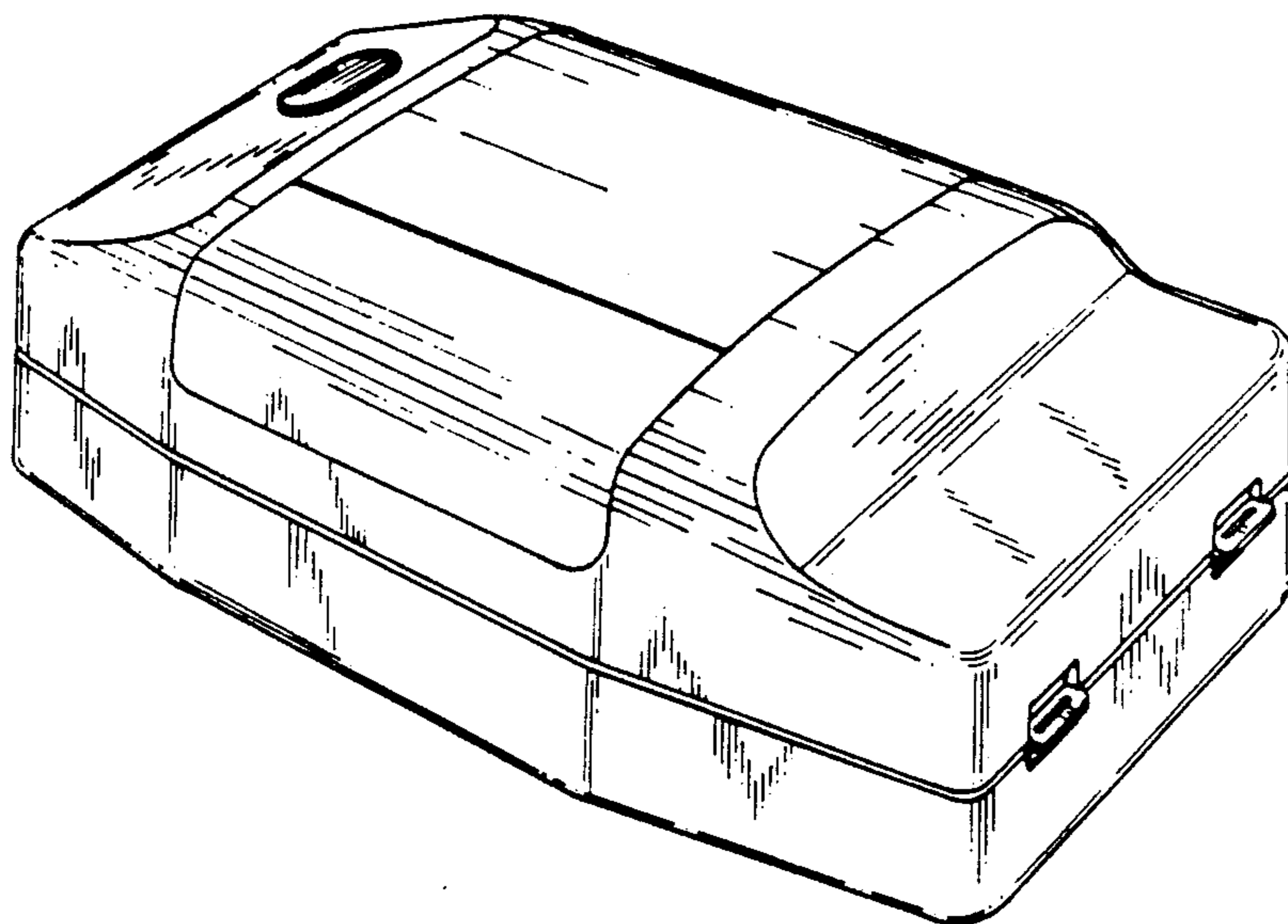

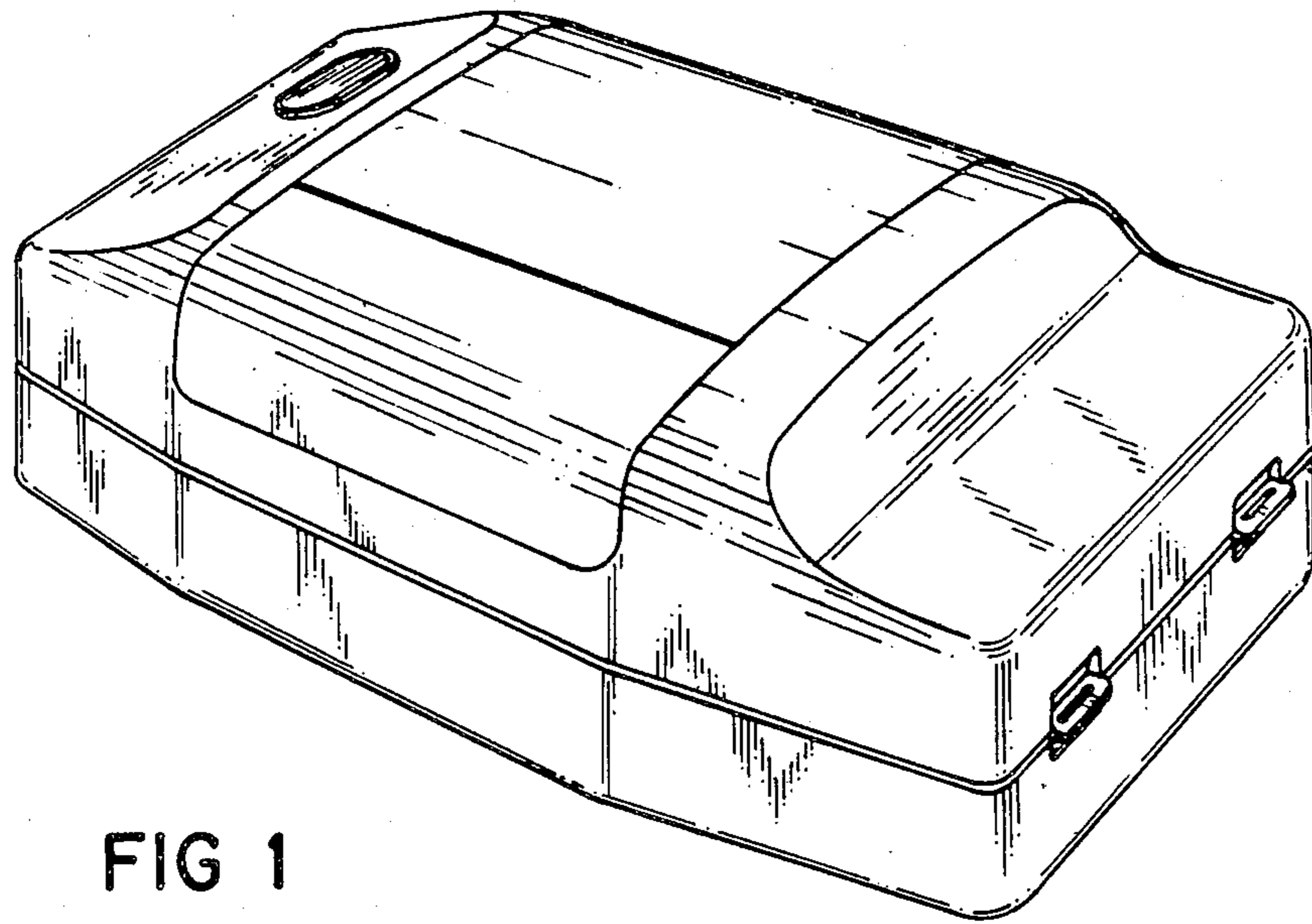

FIG 1

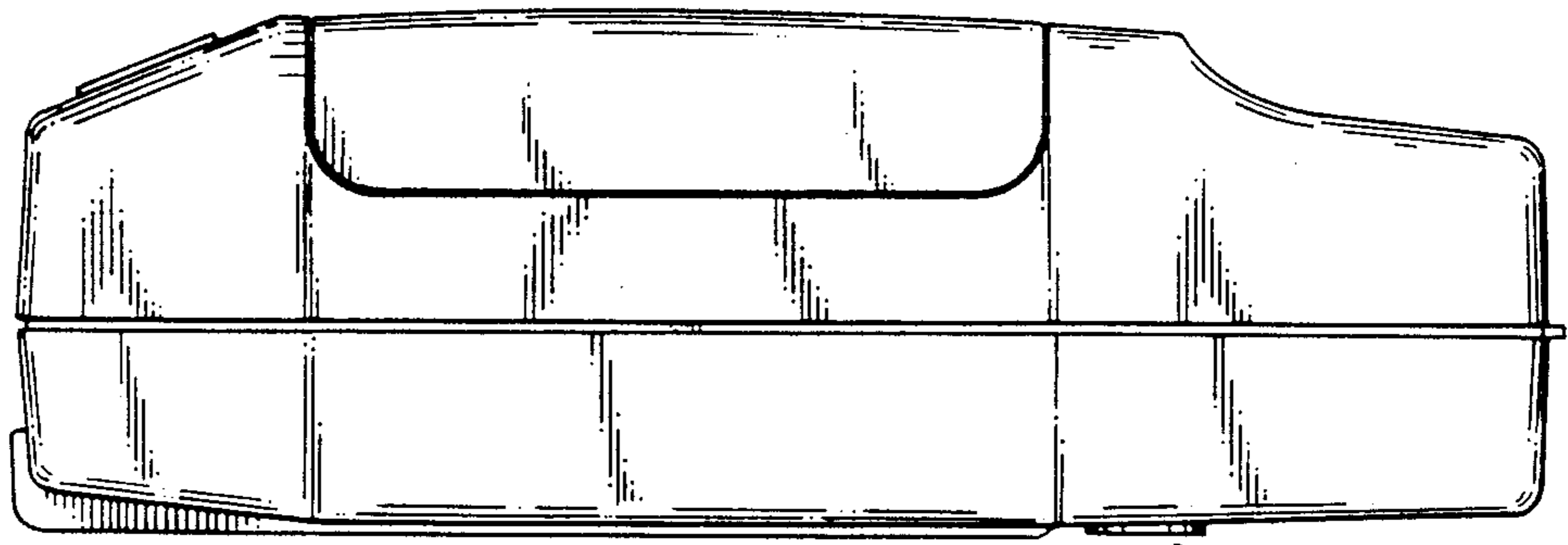

FIG 2

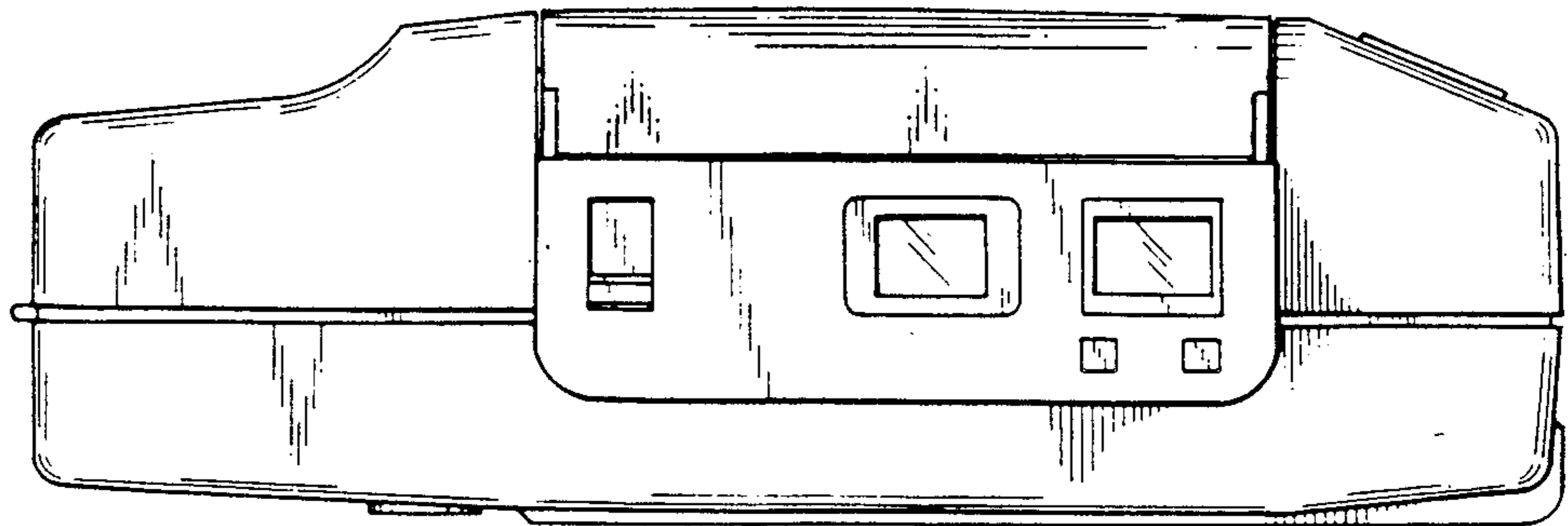

FIG 3

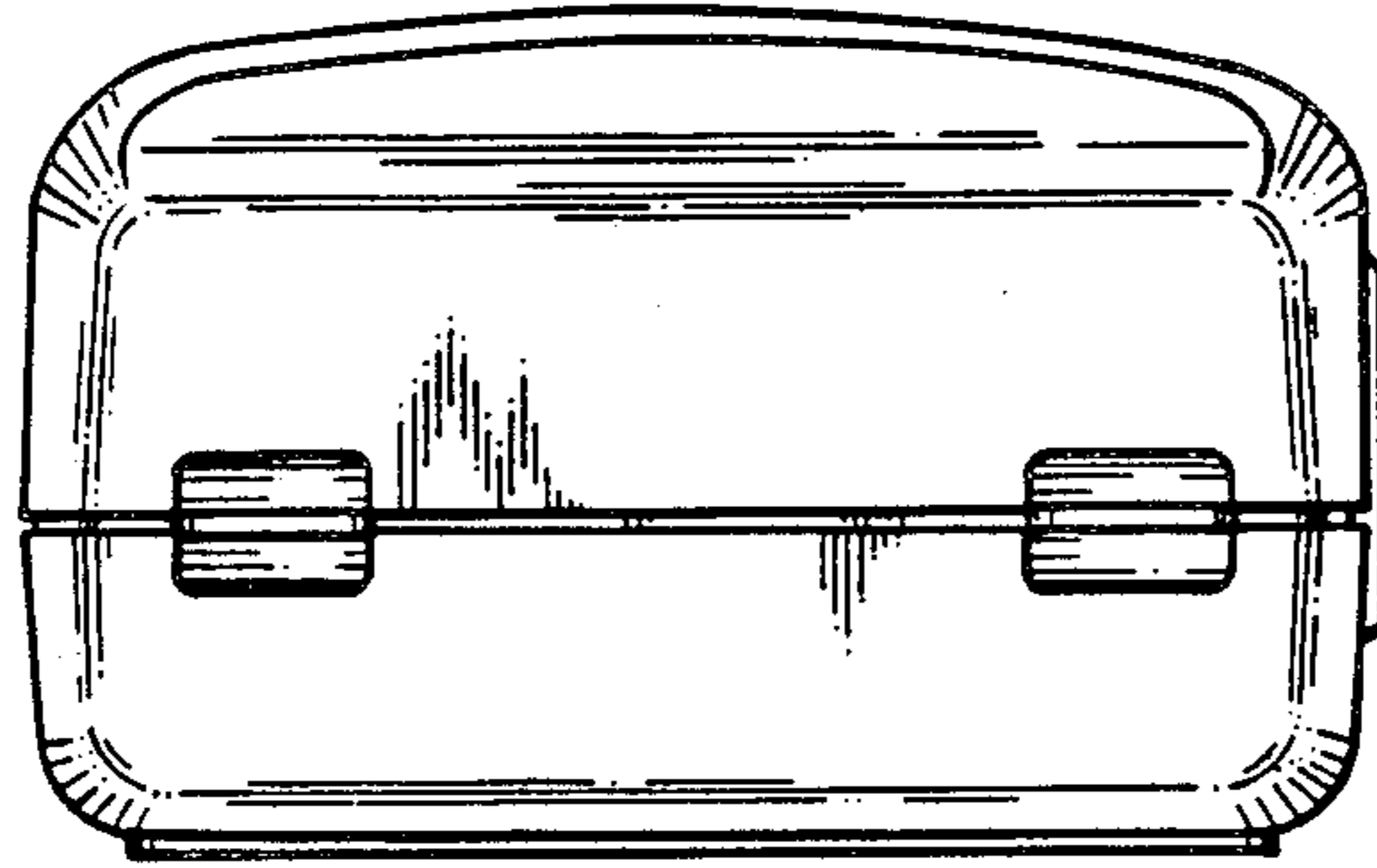

FIG 4

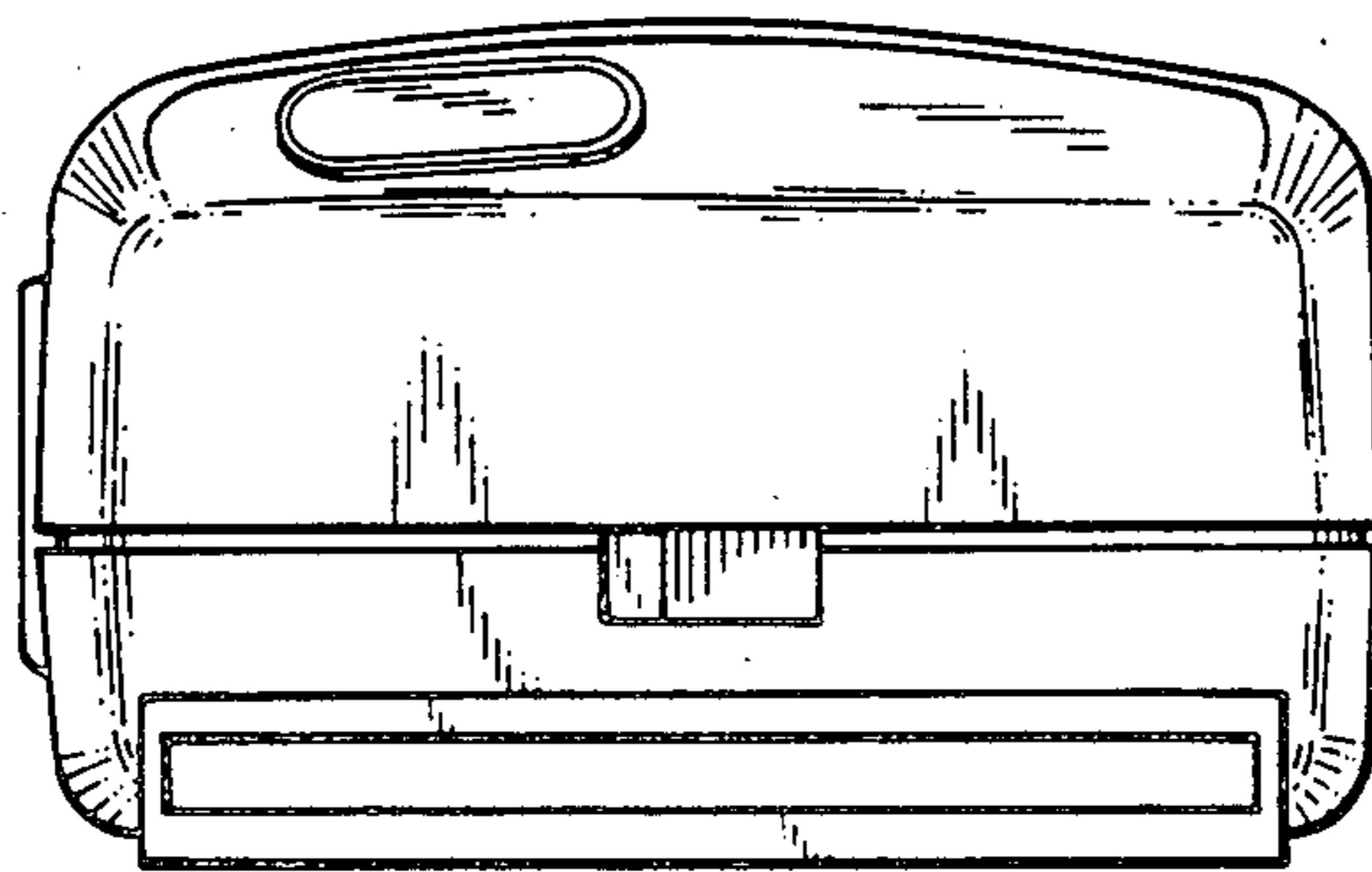

FIG 5

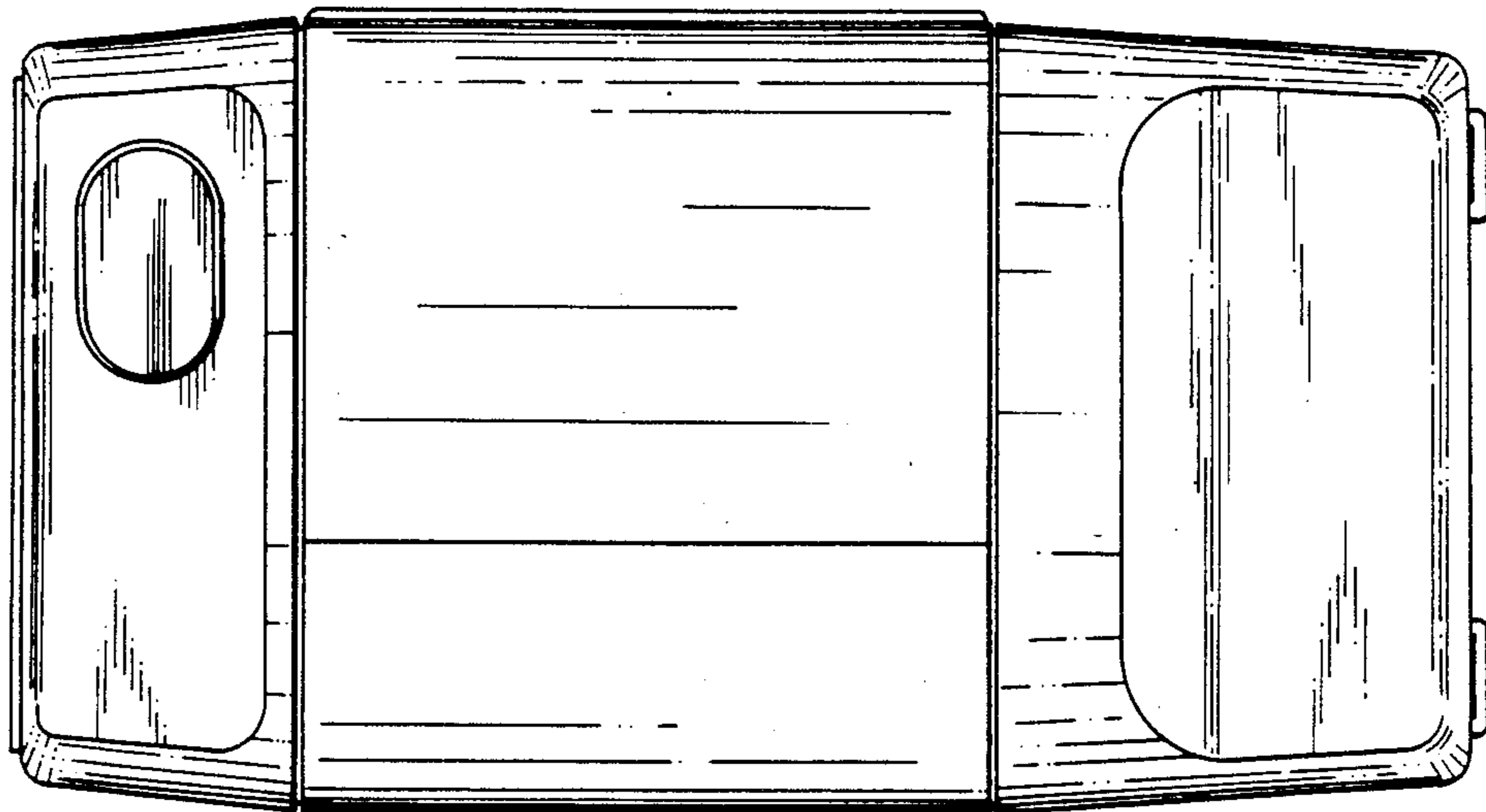

FIG 6

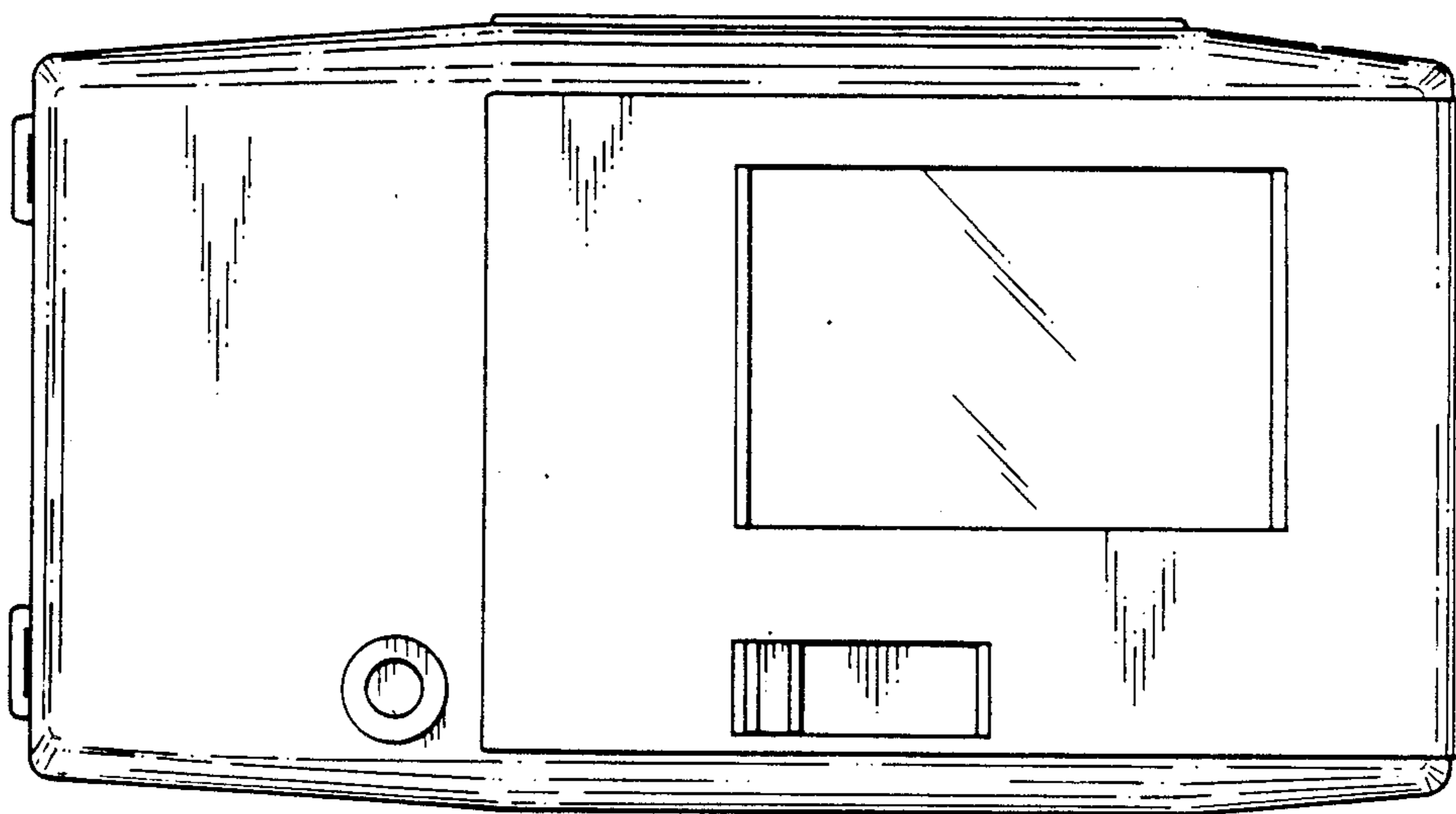

FIG 7