

[54] WRIST WATCH

[75] Inventor: Takashi Takeichi, Hamuramachi, Japan

[73] Assignee: Casio Computer Co., Ltd., Tokyo, Japan

[**] Term: 14 Years

[21] Appl. No.: 790,413

[22] Filed: Oct. 23, 1985

[30] Foreign Application Priority Data

May 14, 1985 [JP] Japan 60-19817

[52] U.S. Cl. D10/39

[58] Field of Search D10/30-39, D10/122-126; 368/276-277, 280-282, 285

[56] References Cited

U.S. PATENT DOCUMENTS

D. 195,421	6/1963	Huguenin	D10/39
D. 264,945	6/1982	Pennell	D10/32
3,427,800	2/1969	Blum	368/223

OTHER PUBLICATIONS

Skin Diver—11/79—p. 19, Watches at top.
Swiss Watch & Jewelry Journal—2/80—p. 254—Watches at left.

European Jeweler—7/84—p. 59—All Watches.

Primary Examiner—Nelson C. Holtje
Attorney, Agent, or Firm—Frishauf, Holtz, Goodman & Woodward

[57] CLAIM

The ornamental design for a wrist watch, substantially as shown.

DESCRIPTION

FIG. 1 is a front elevational view of a wrist watch showing my new design;
FIG. 2 is a top plan view thereof;
FIG. 3 is a right side elevational view thereof;
FIG. 4 is a left side elevational view thereof;
FIG. 5 is a bottom plan view thereof;
FIG. 6 is a rear elevational view thereof; and
FIG. 7 is a perspective view thereof.

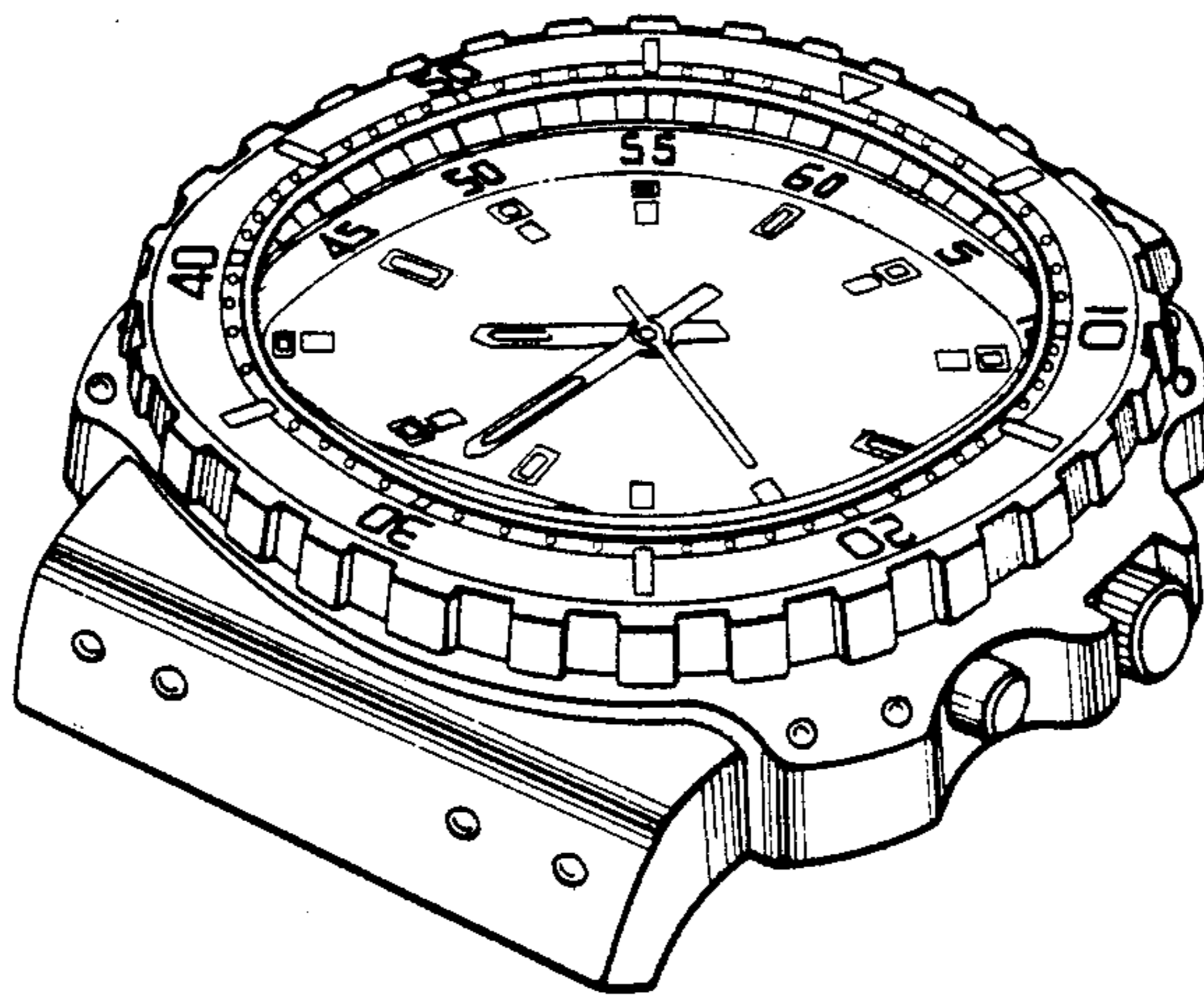

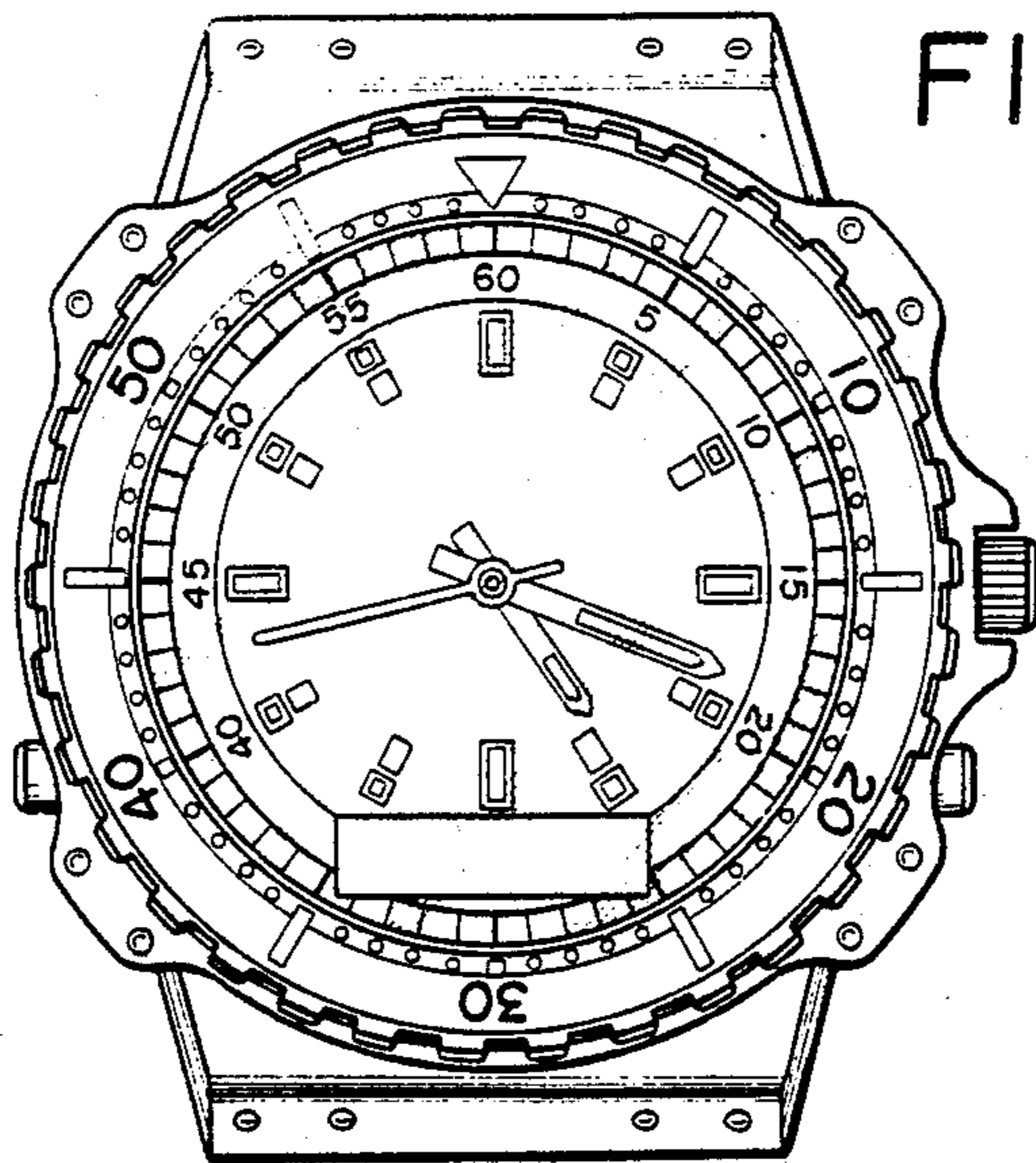

FIG. 1

FIG. 2

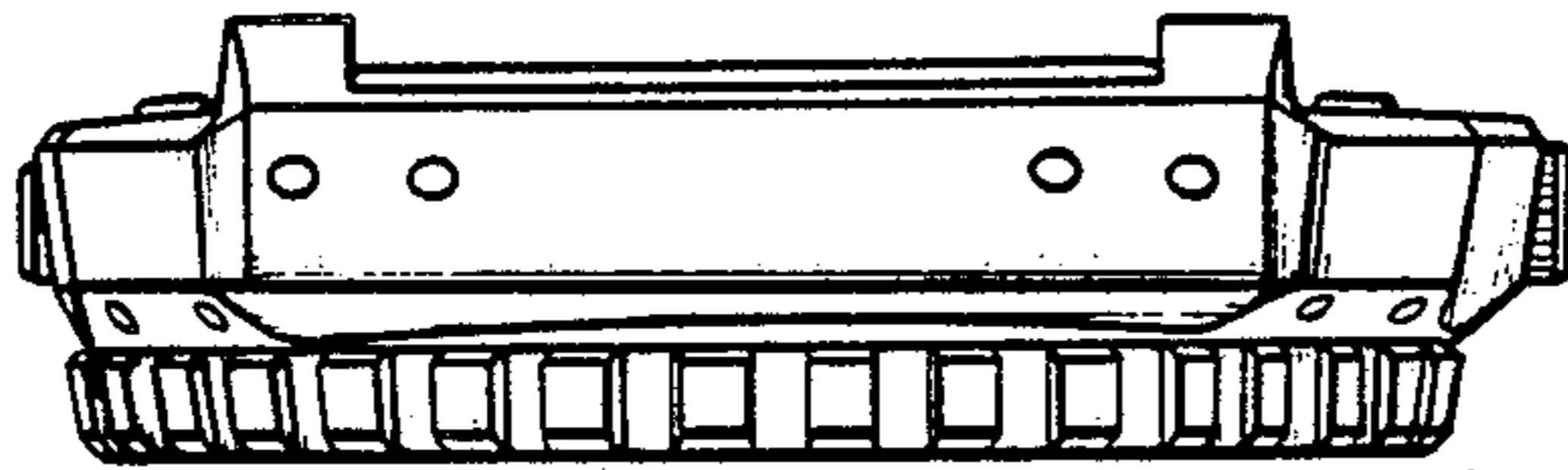

FIG. 4

FIG. 3

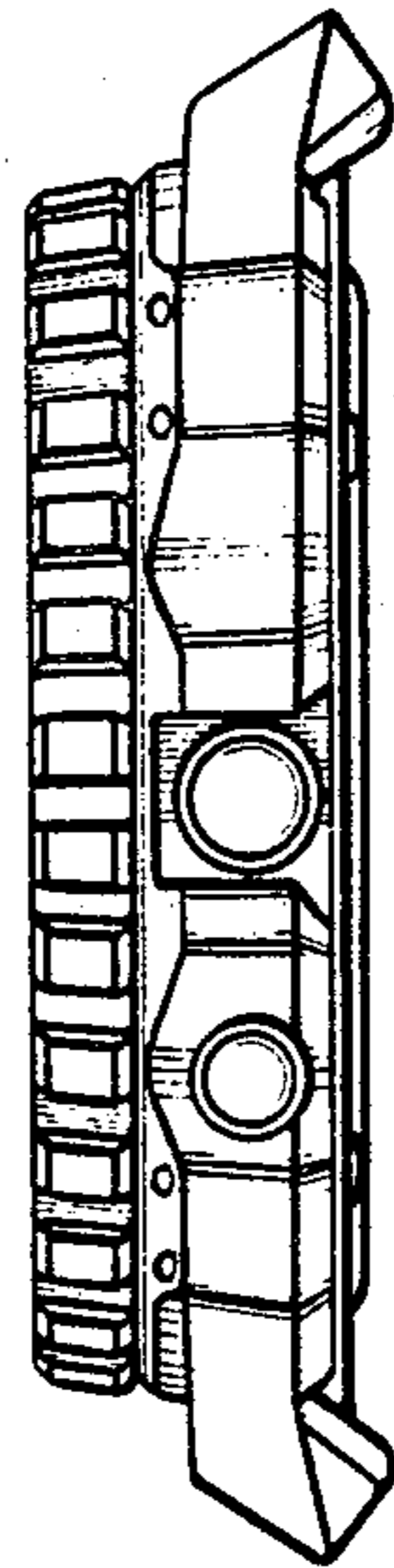
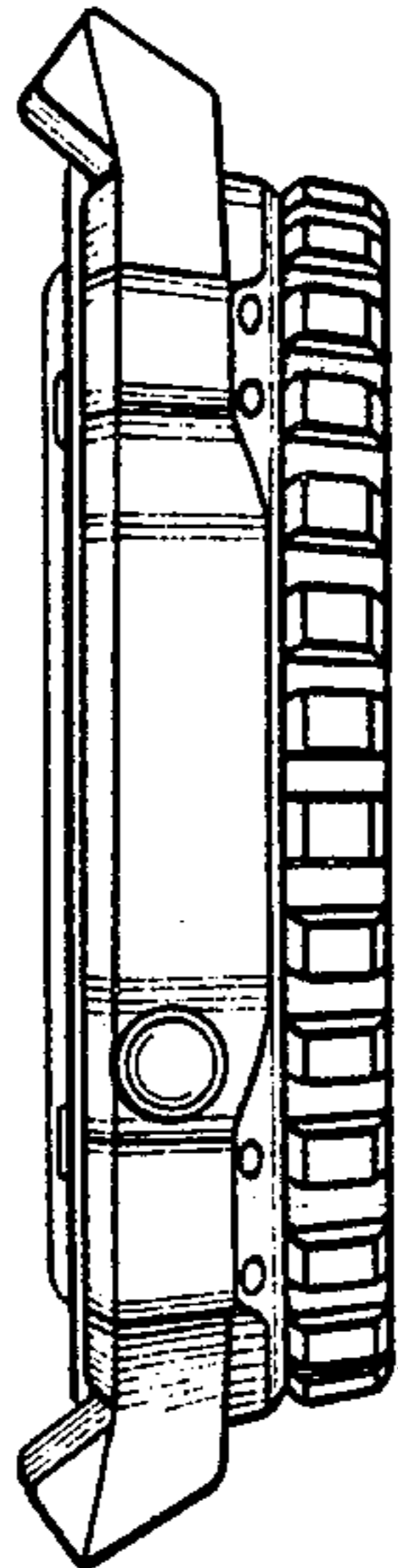

FIG. 5

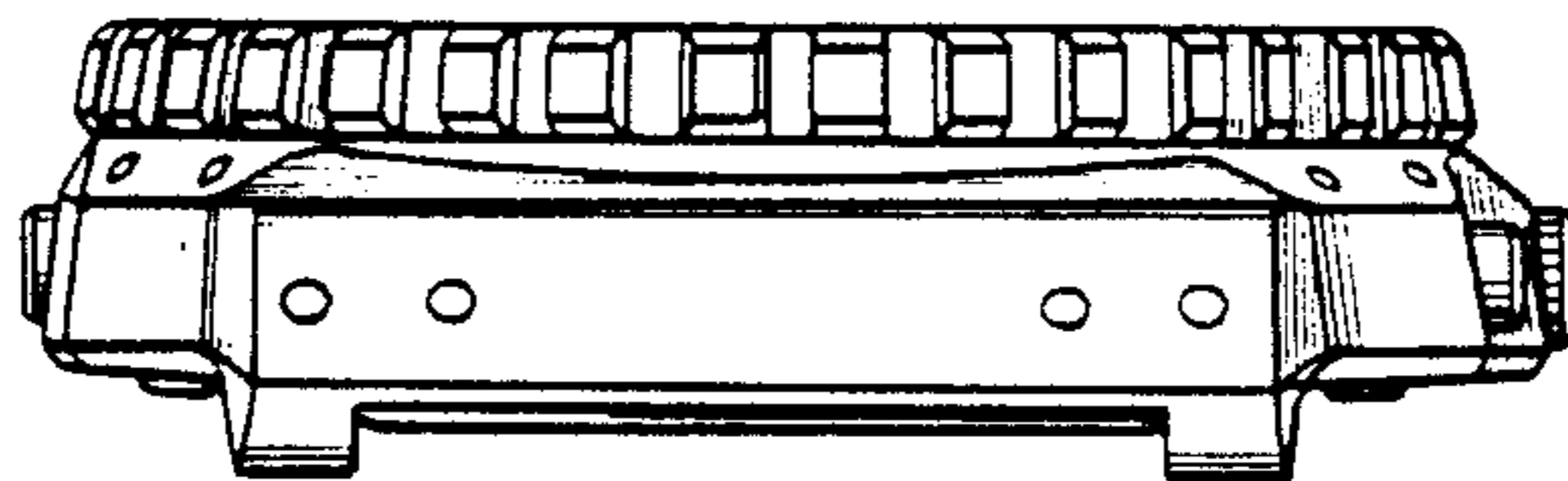

FIG. 6

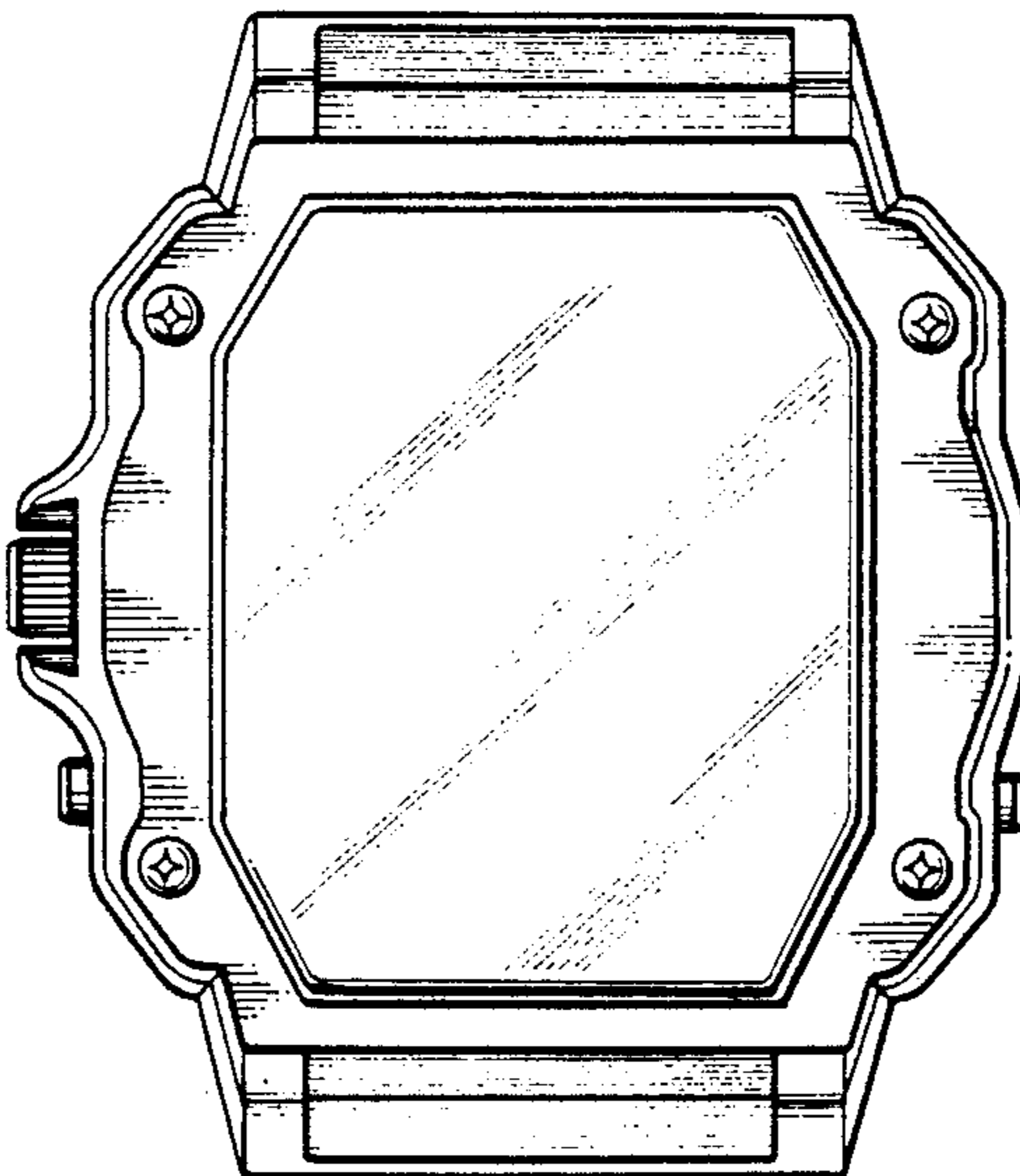

FIG. 7

