

[54] **COSMETIC HOLDER HAVING
REMOVABLE COVER AND ACCESSORY
TRAY**

[75] Inventors: **Ronald Wadsworth**, Diamond Bar;
Carl A. Meisterlin, Long Beach;
Richard K. O'Neill, Pomona; **Richard
P. Grogan**, Downey; **Brian R.
Lindley**, Costa Mesa, all of Calif.

[73] Assignee: **La Shea Corporation**, Costa Mesa,
Calif.

[**] Term: **14 Years**

[21] Appl. No.: **783,880**

[22] Filed: **Oct. 3, 1985**

[52] U.S. Cl. **D28/77; D3/39;
D28/73**

[58] Field of Search **D28/4-10,
D28/38, 61, 73, 76-91.1, 99; D3/39; D9/341,
347; 219/222; 206/581, 235, 385, 823; 132/1 R,
79 R-79 S, 79 F, 79 G**

[56] **References Cited**

U.S. PATENT DOCUMENTS

D. 107,340	12/1937	Lux	D3/39
D. 144,350	4/1946	Botkin	D19/85 X
D. 249,273	9/1978	Day	D19/78
D. 252,409	7/1979	Rose et al.	D3/39
D. 255,065	5/1980	Salacuse	D28/73
D. 261,583	11/1981	Labasan	D19/85 X
D. 269,467	6/1983	Mann	D28/73
D. 281,929	12/1985	Strobel et al.	D28/76 X
3,410,985	11/1968	Giacchero	219/222
4,412,618	11/1983	La Conte	206/581

Primary Examiner—Louis S. Zarfes
Attorney, Agent, or Firm—Morland C. Fischer

[57] **CLAIM**

The ornamental design for a cosmetic holder having removable cover and accessory tray, as shown and described.

DESCRIPTION

FIG. 1 is a perspective view of a cosmetic holder having a removable cover and accessory tray showing our new design;
FIG. 2 is an exploded perspective view;
FIG. 3 is a front elevational view of the cosmetic holder with the top and accessory tray removed therefrom;
FIG. 4 is a back elevational view;
FIG. 5 is a bottom plan view;
FIG. 6 is a top plan view;
FIG. 7 is a side elevational view;
FIG. 8 is an opposite side elevational view;
FIG. 9 is a front elevational view of the accessory tray removed from the cosmetic holder;
FIG. 10 is a back elevational view;
FIG. 11 is a top plan view;
FIG. 12 is a bottom plan view;
FIG. 13 is a side elevational view;
FIG. 14 is an opposite side elevational view;
FIG. 15 is a front elevational view of the cover removed from the cosmetic holder;
FIG. 16 is a back elevational view;
FIG. 17 is a top plan view;
FIG. 18 is a bottom plan view; and
FIG. 19 is a side elevational view, this side and the opposite side being of identical design.

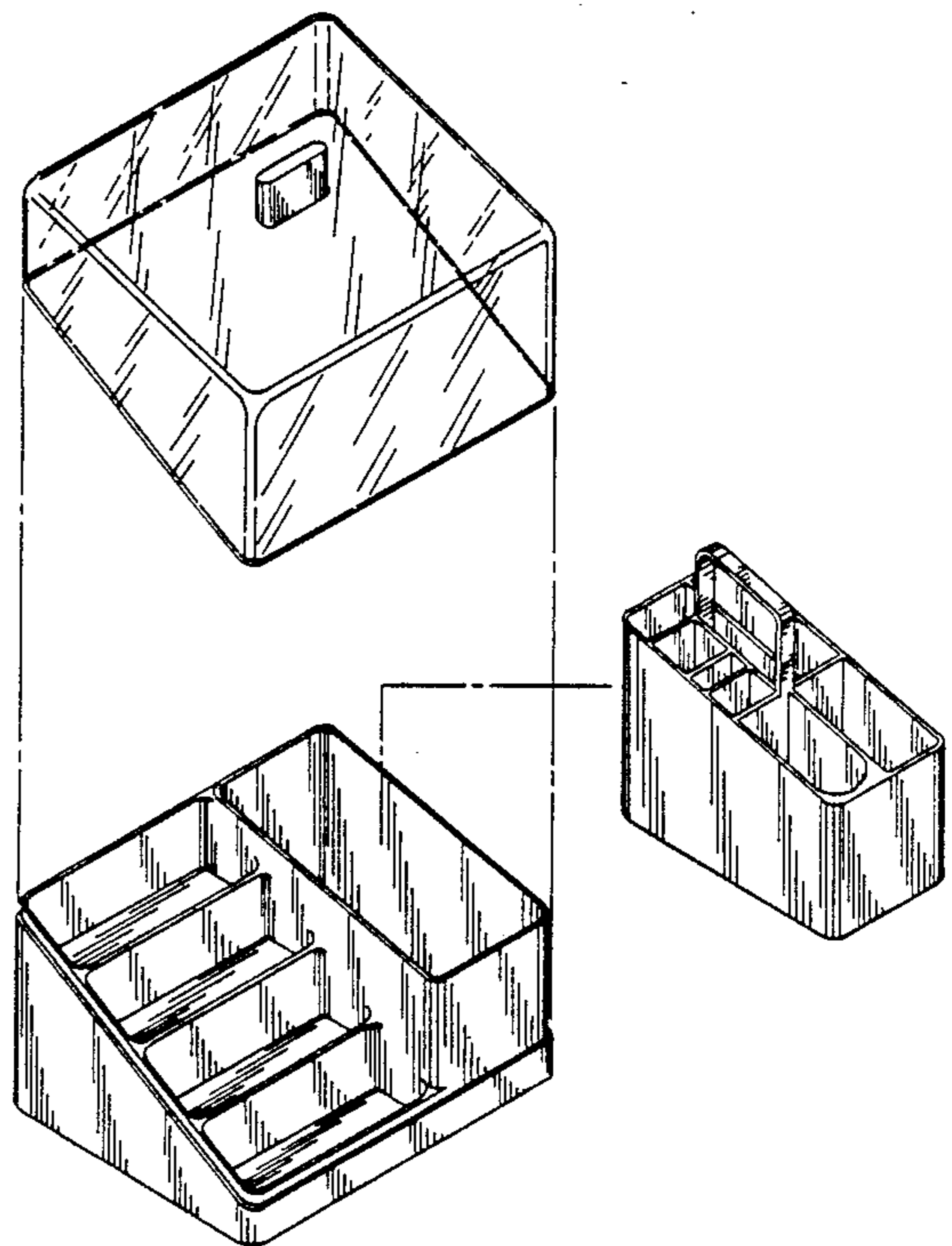
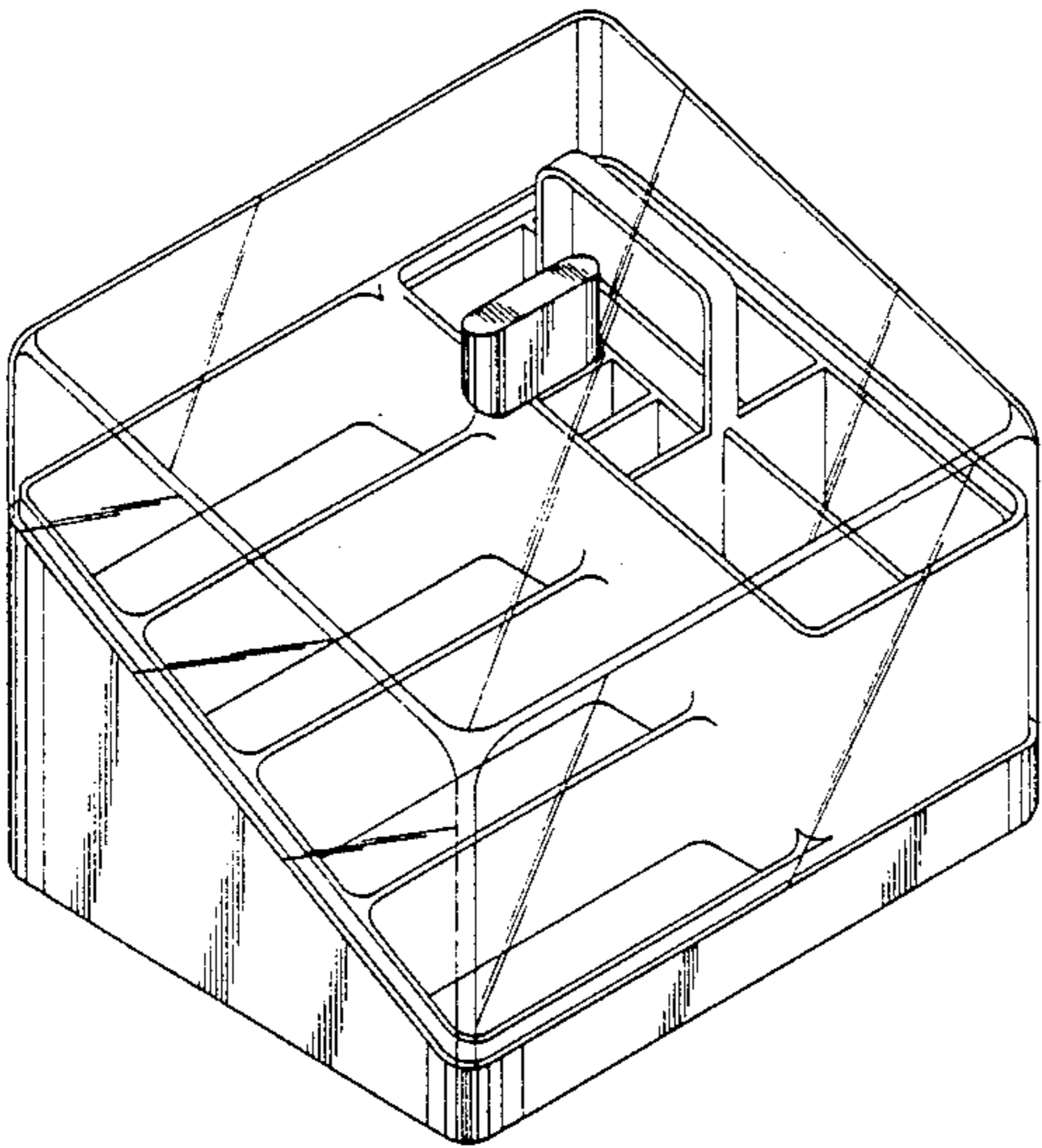

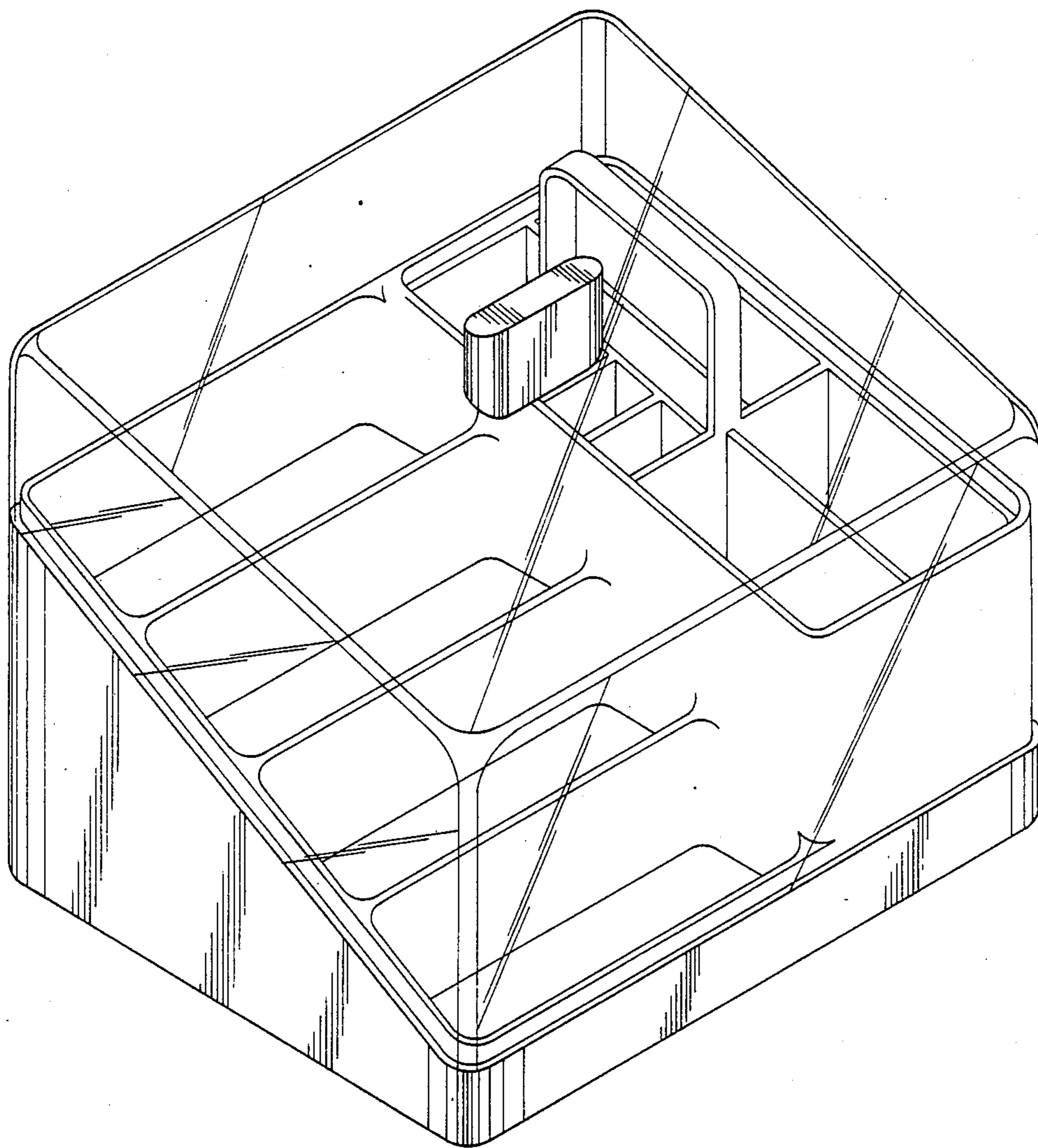

FIG. 1

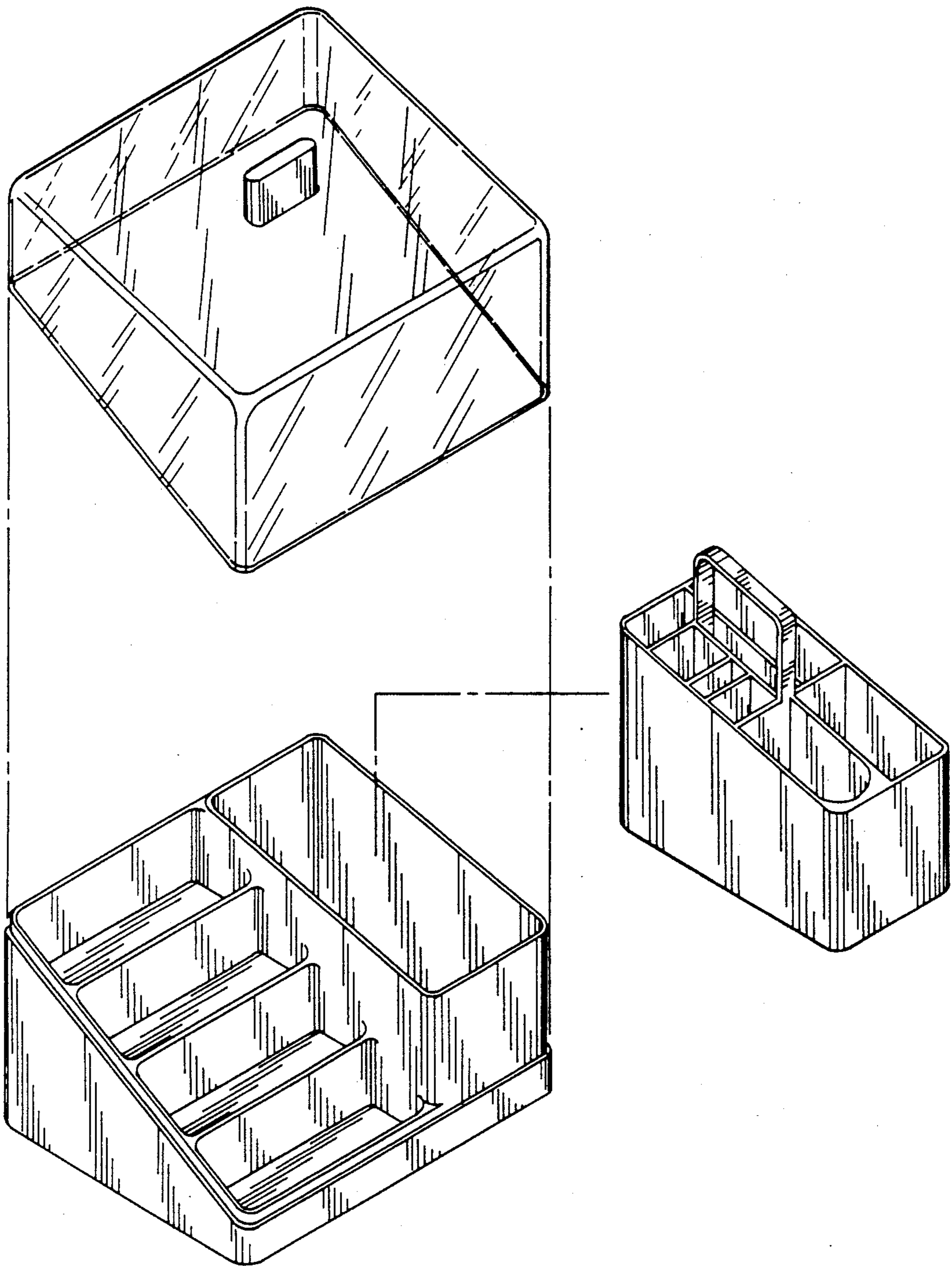

FIG. 2

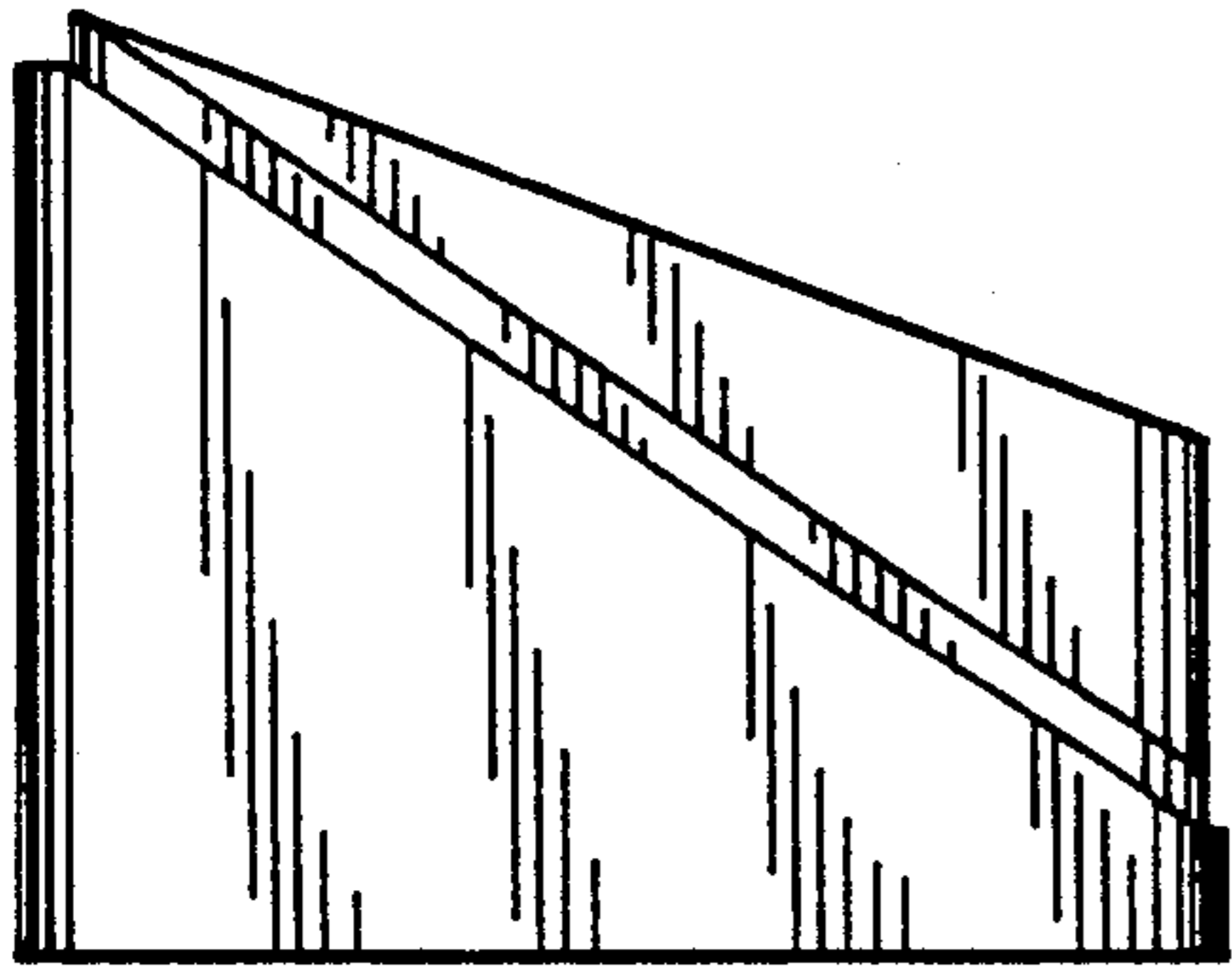

FIG. 7

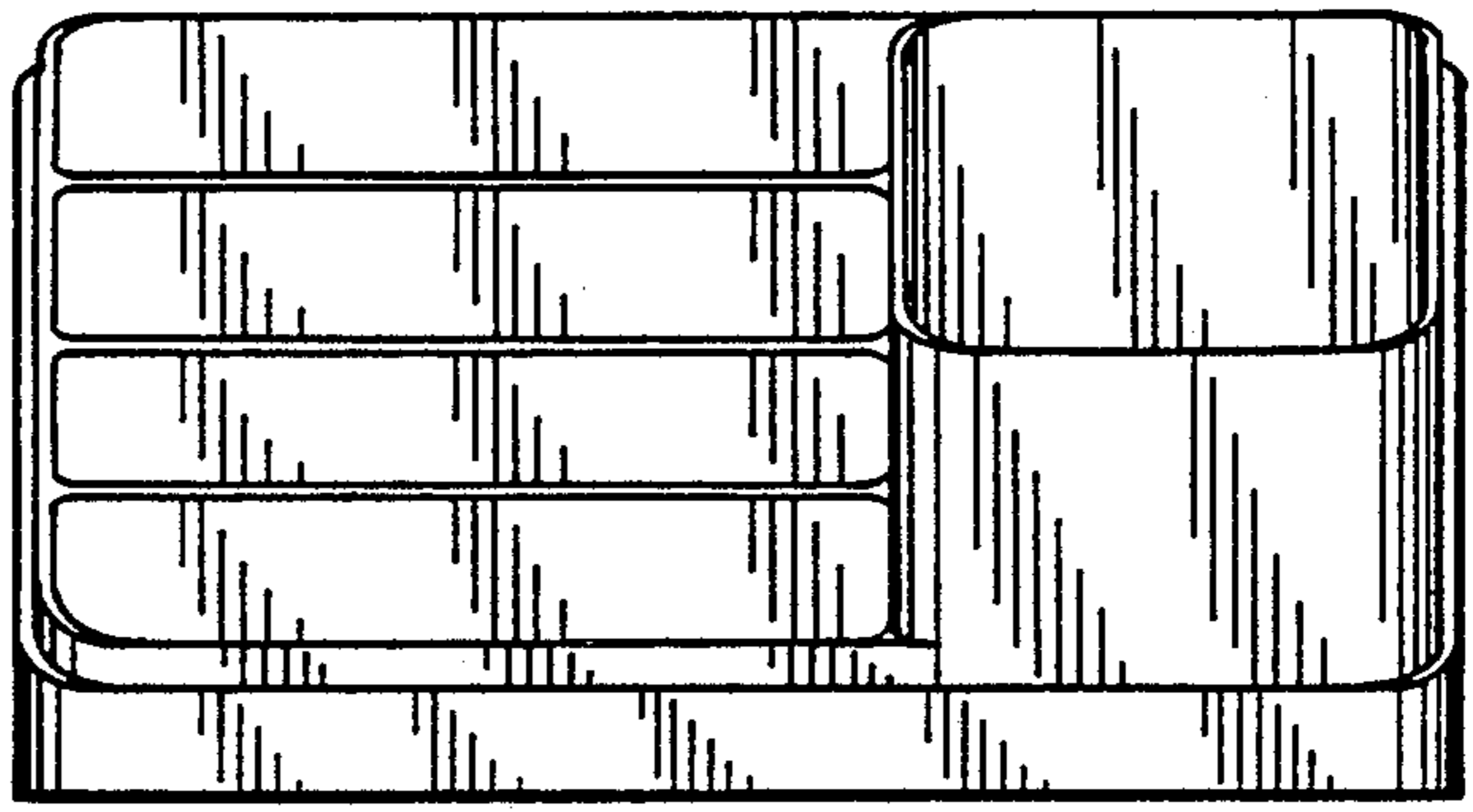

FIG. 3

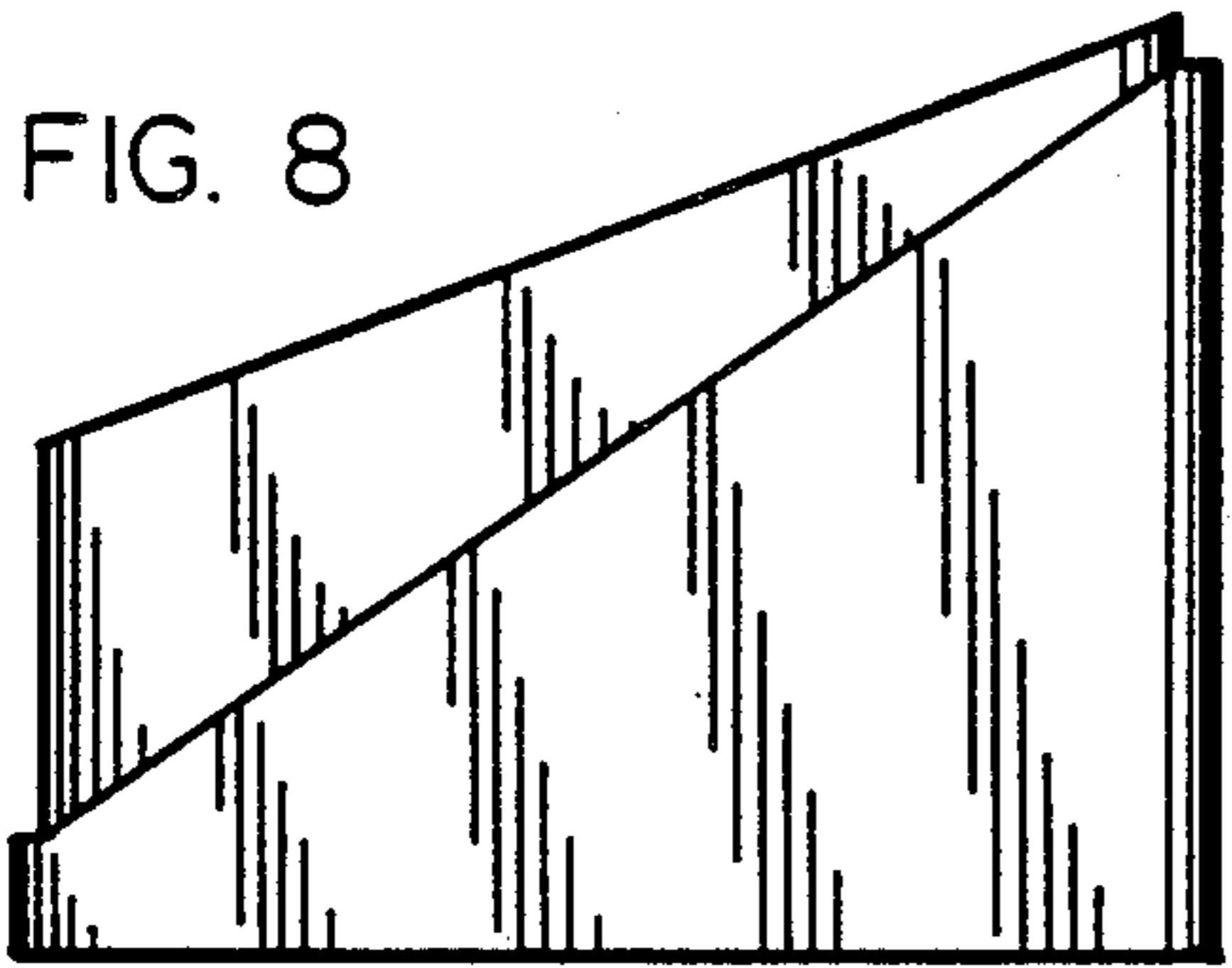

FIG. 8

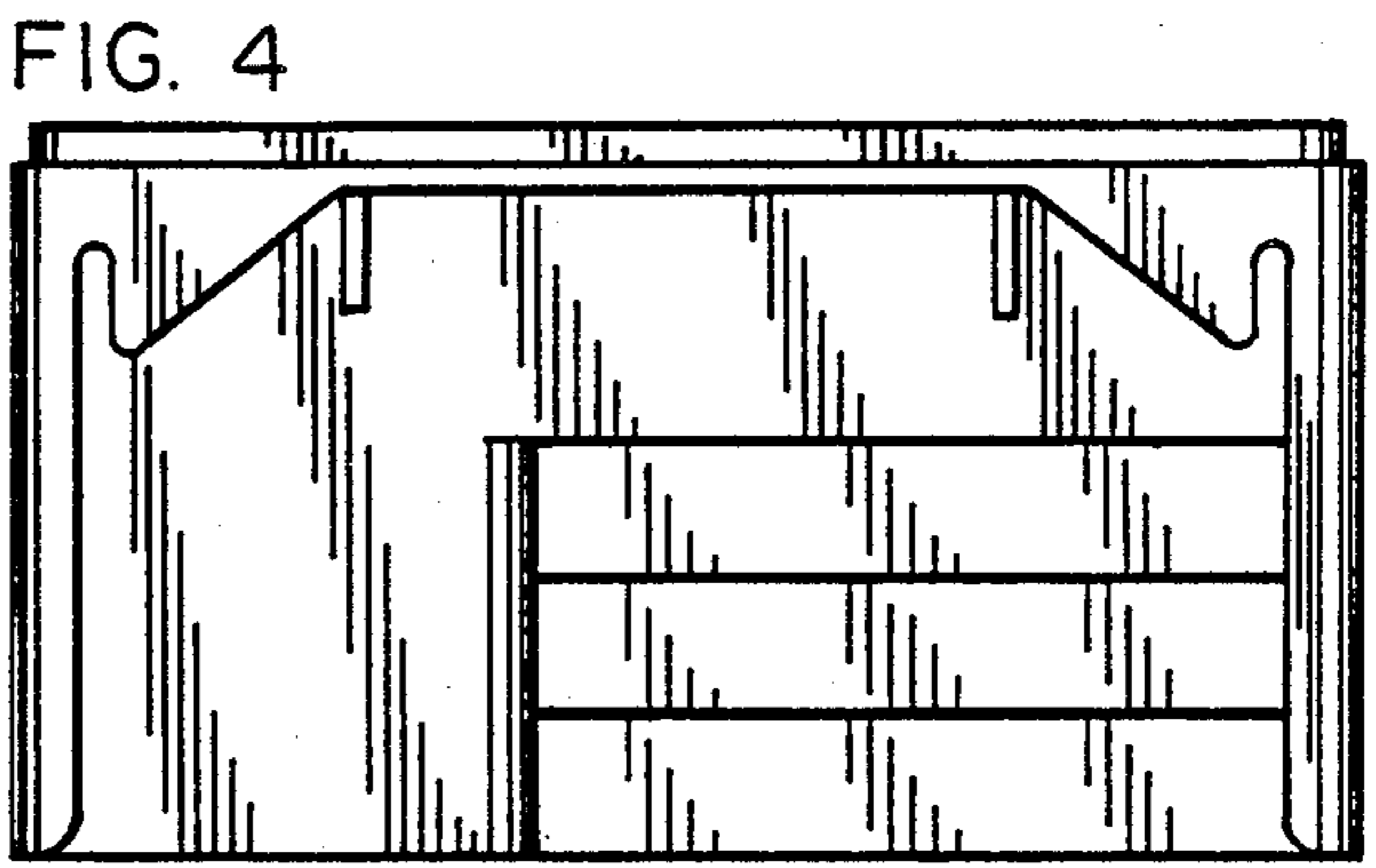

FIG. 4

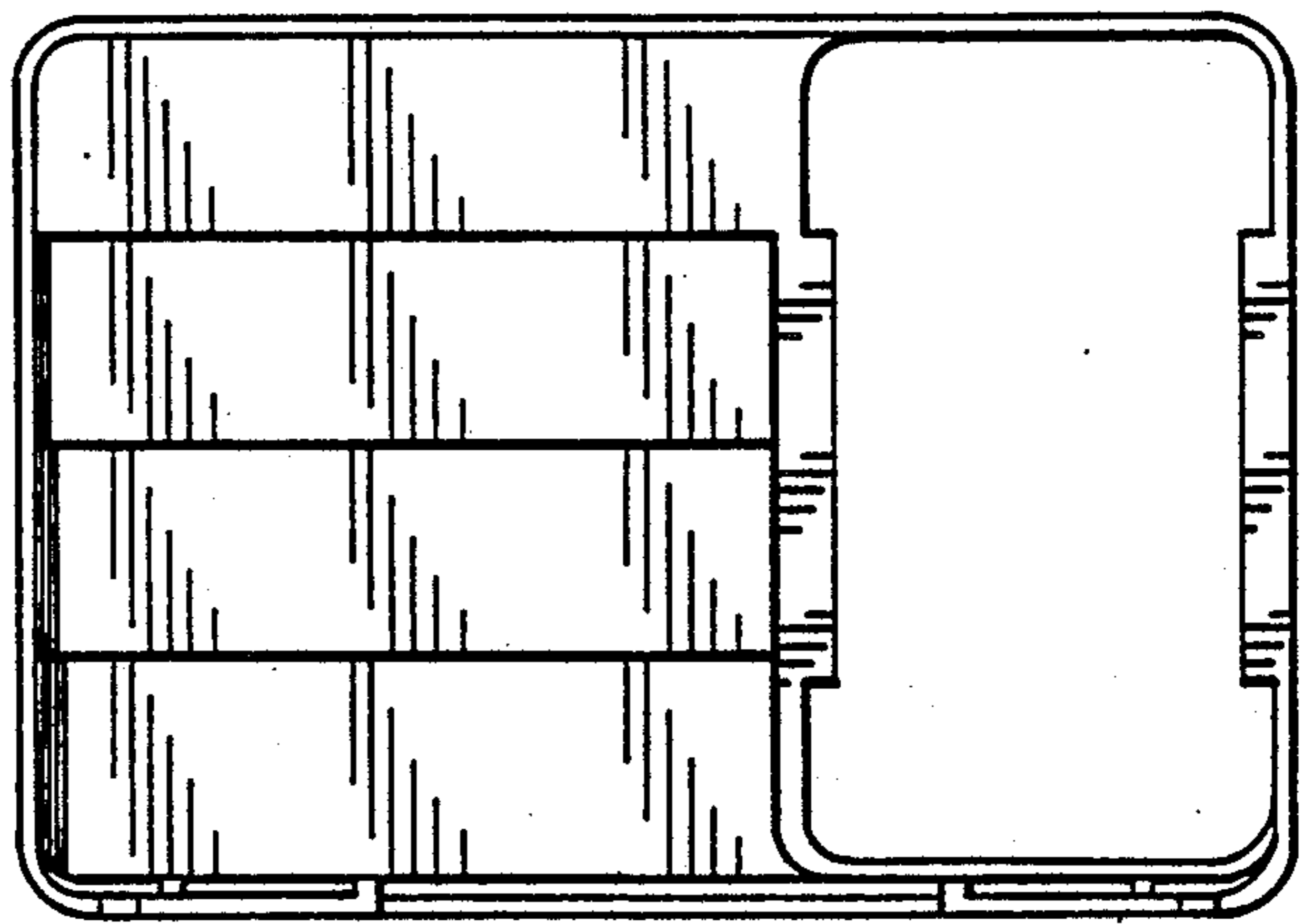

FIG. 5

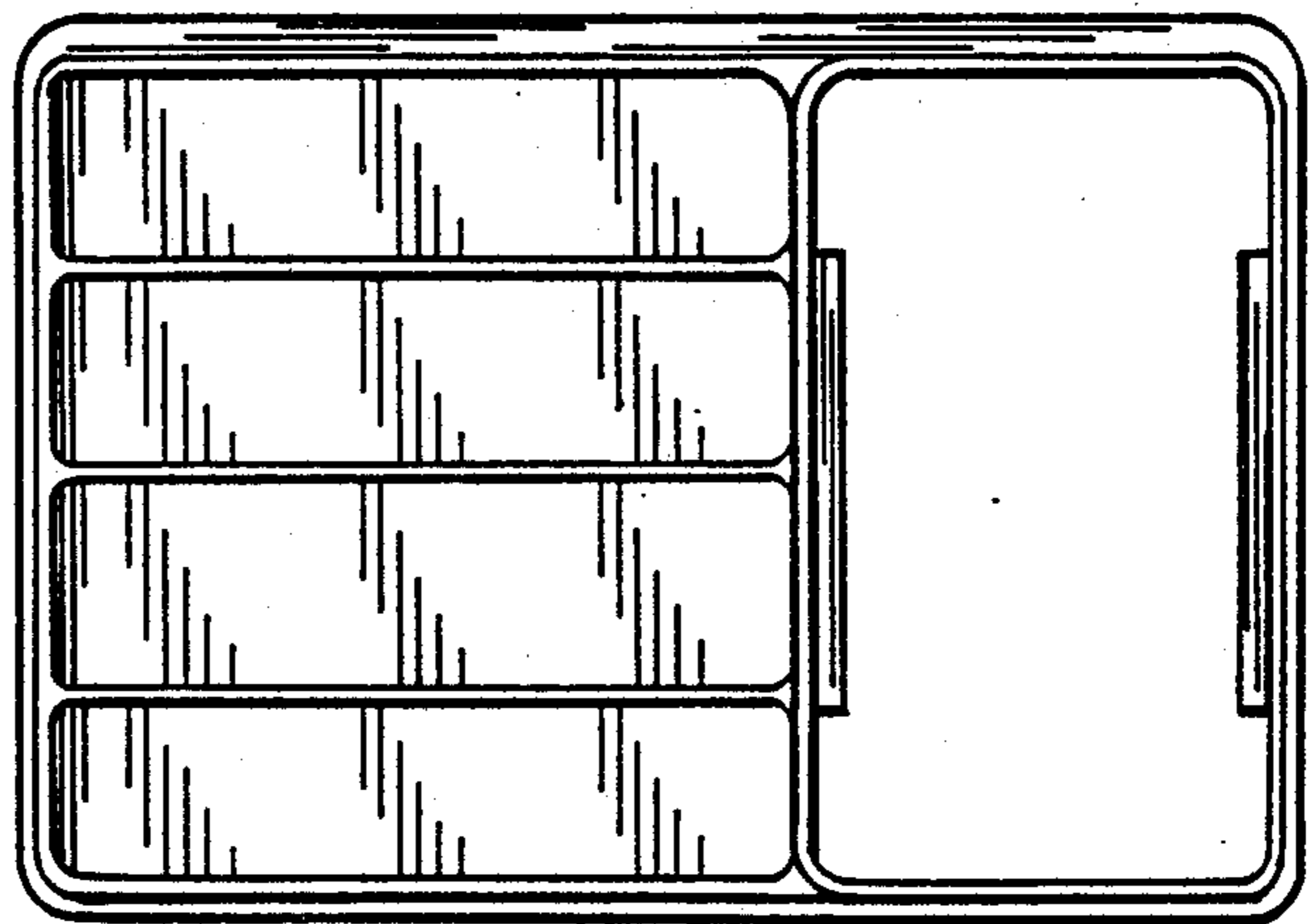

FIG. 6

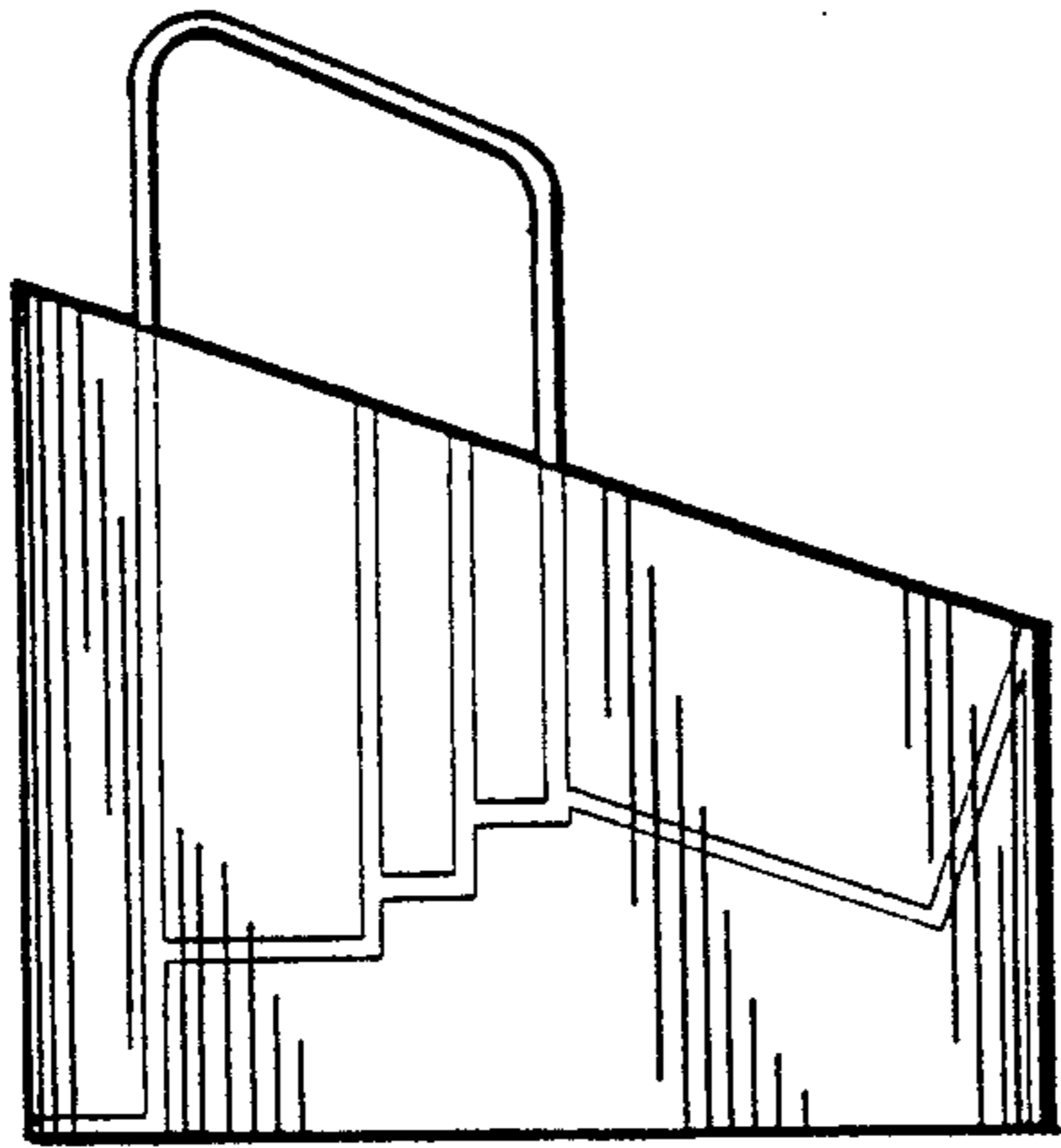

FIG. 13

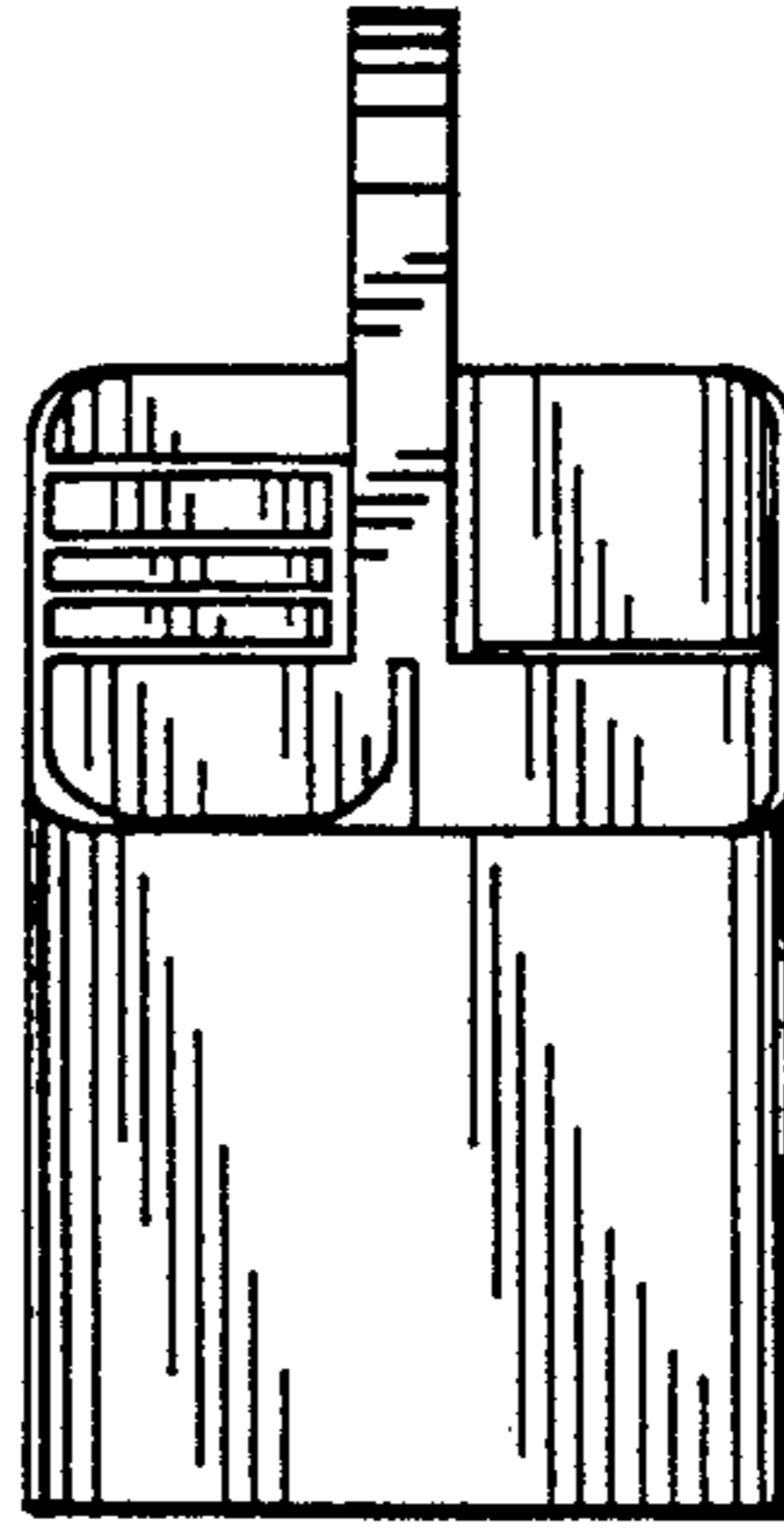

FIG. 9

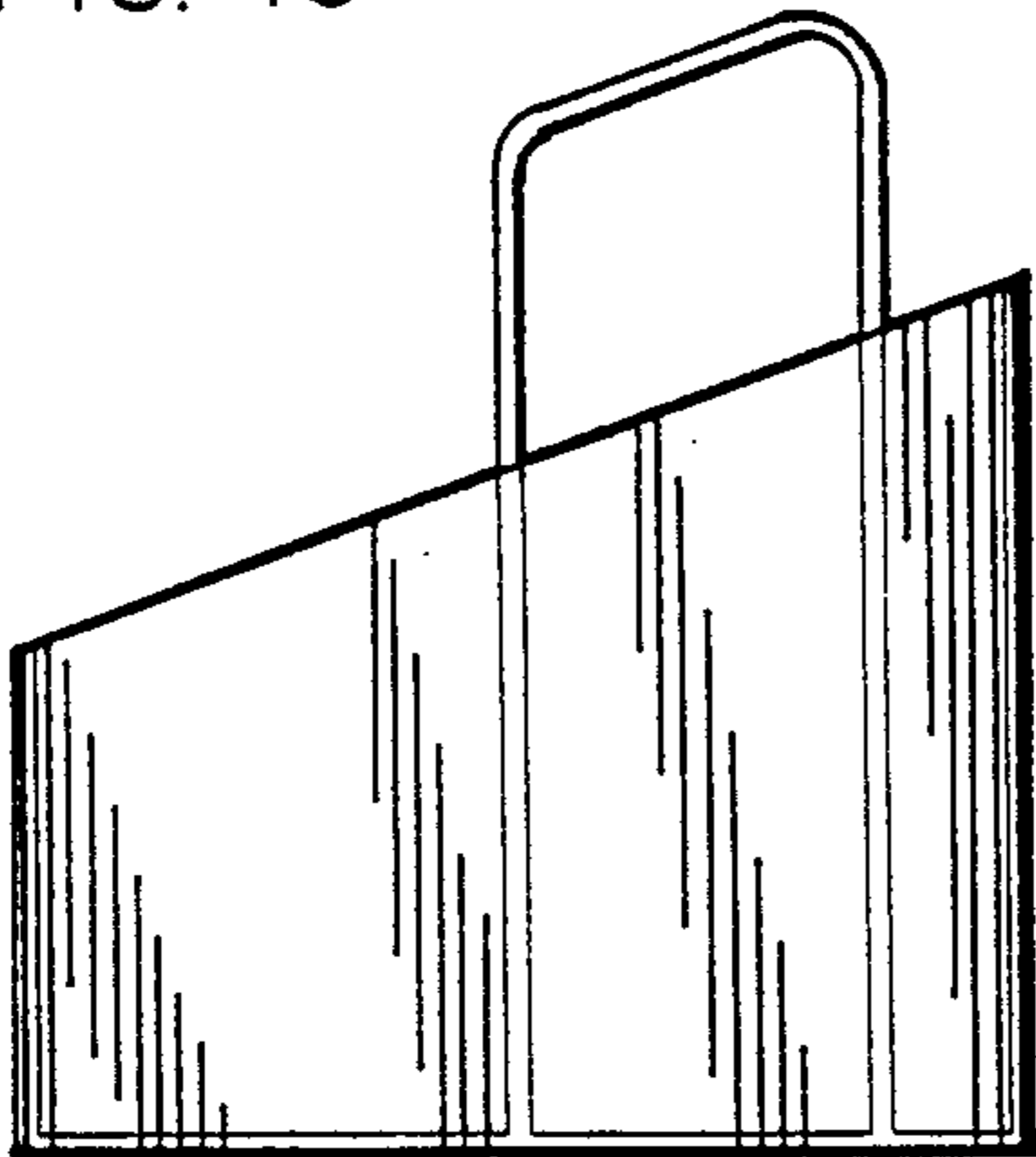

FIG. 14

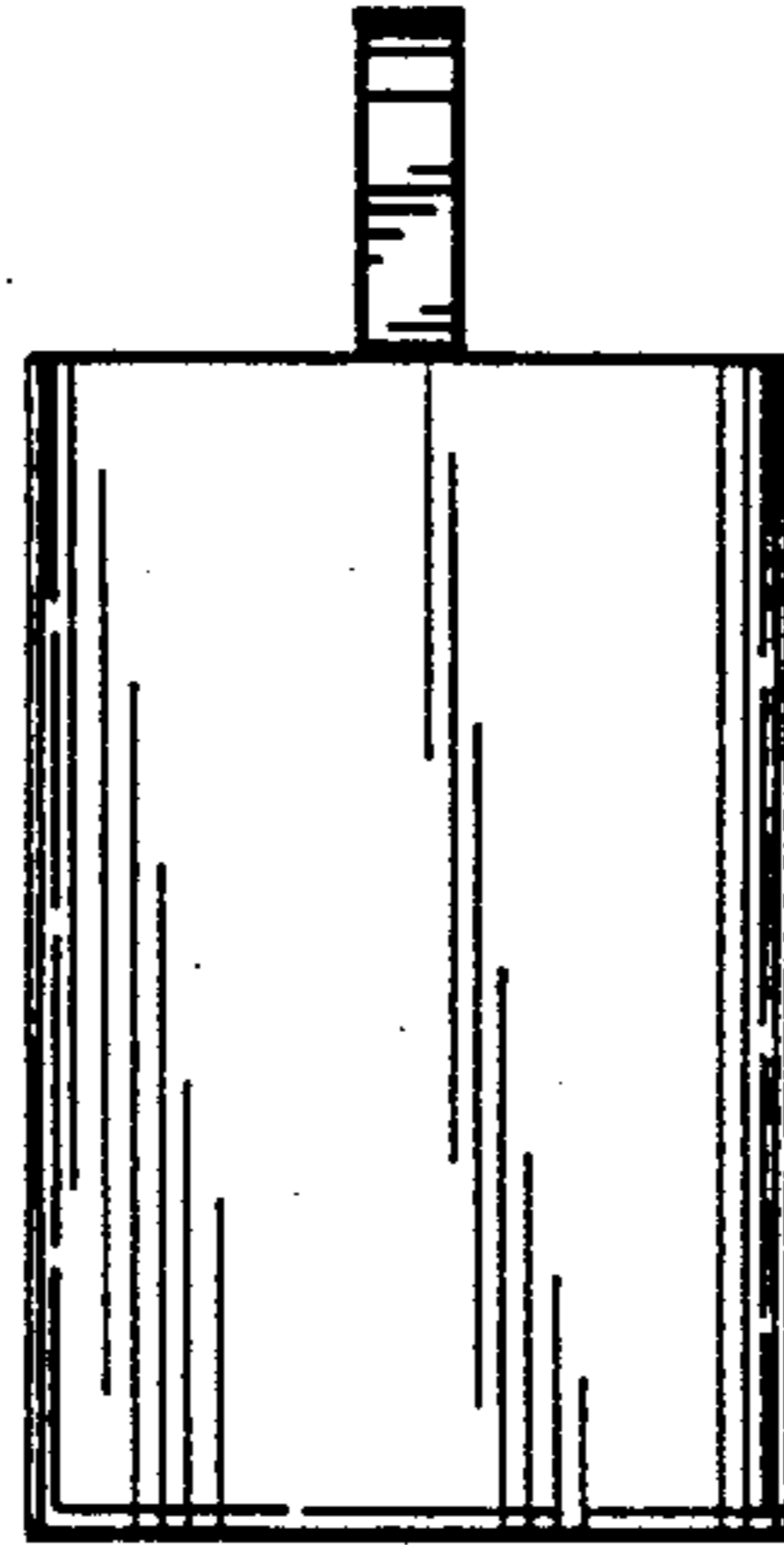

FIG. 10

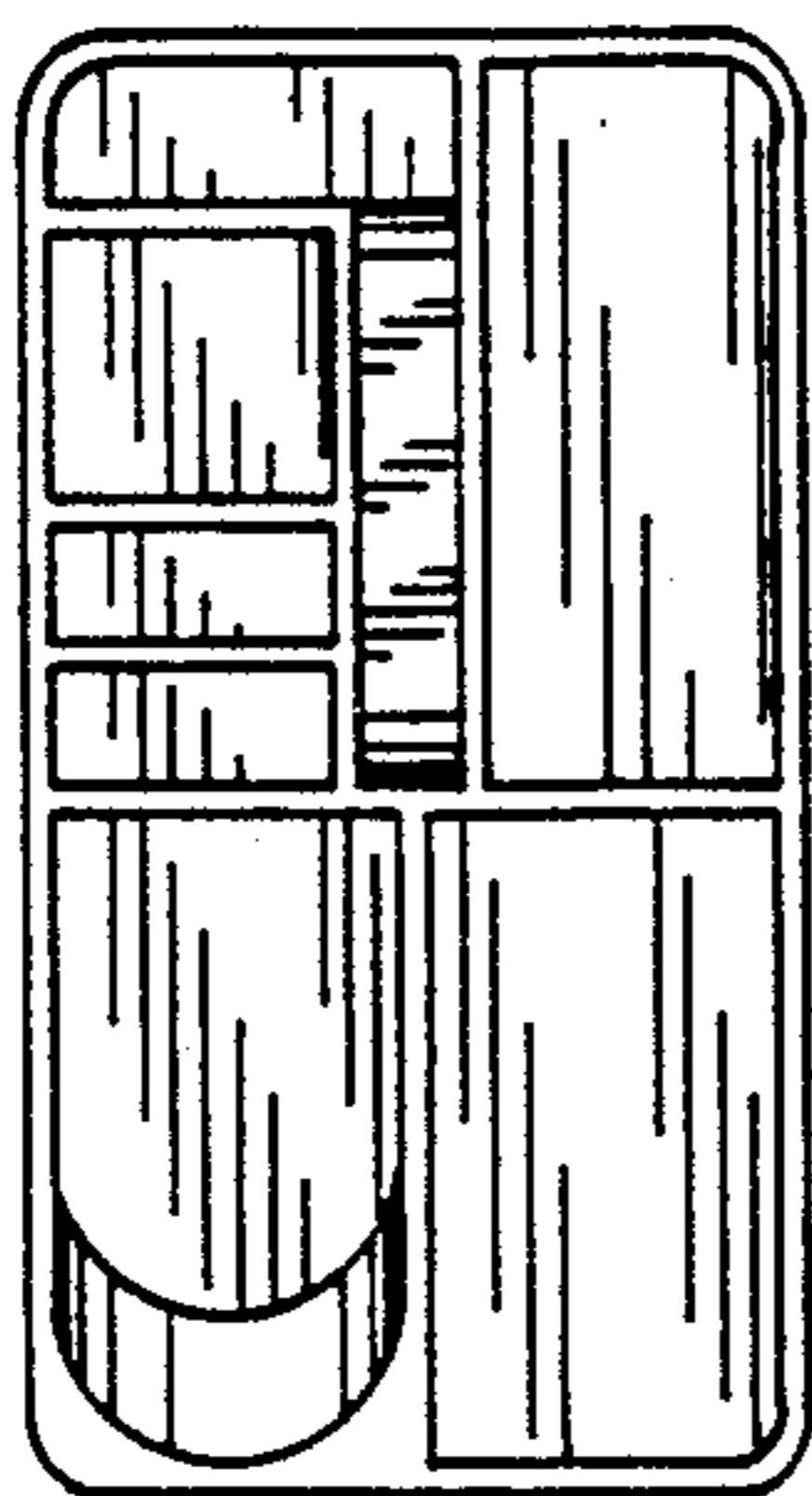

FIG. 11

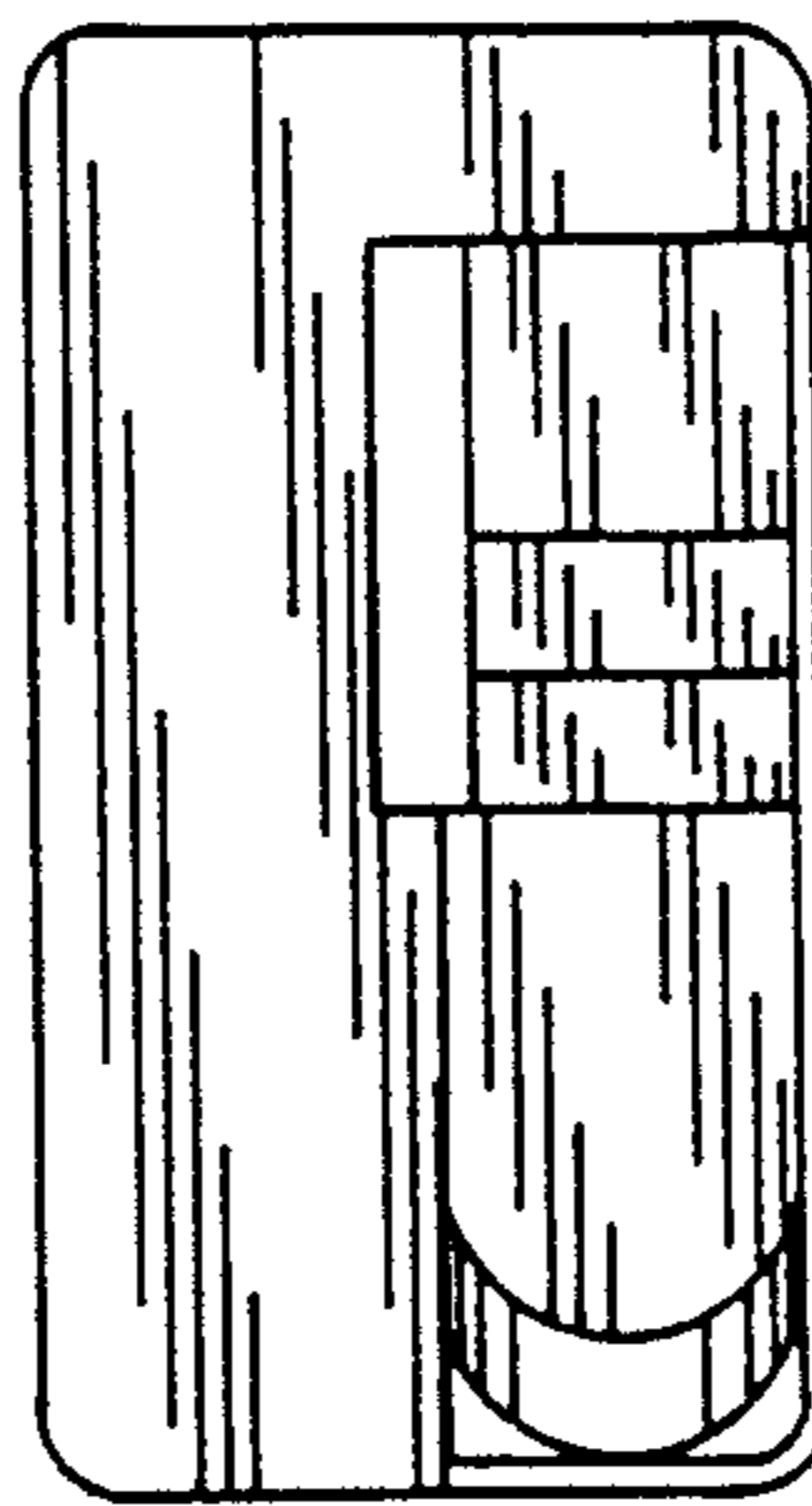

FIG. 12

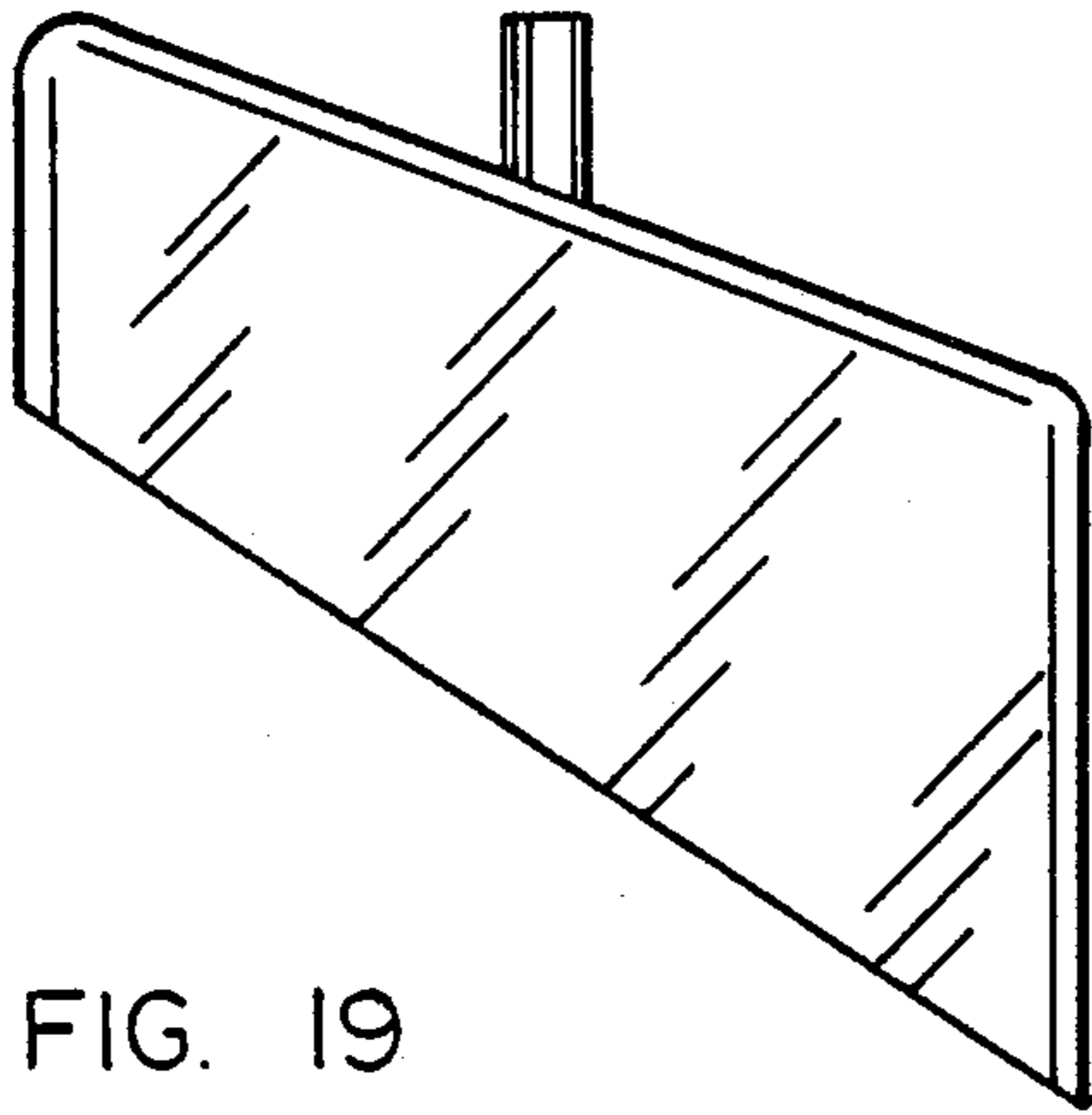

FIG. 19

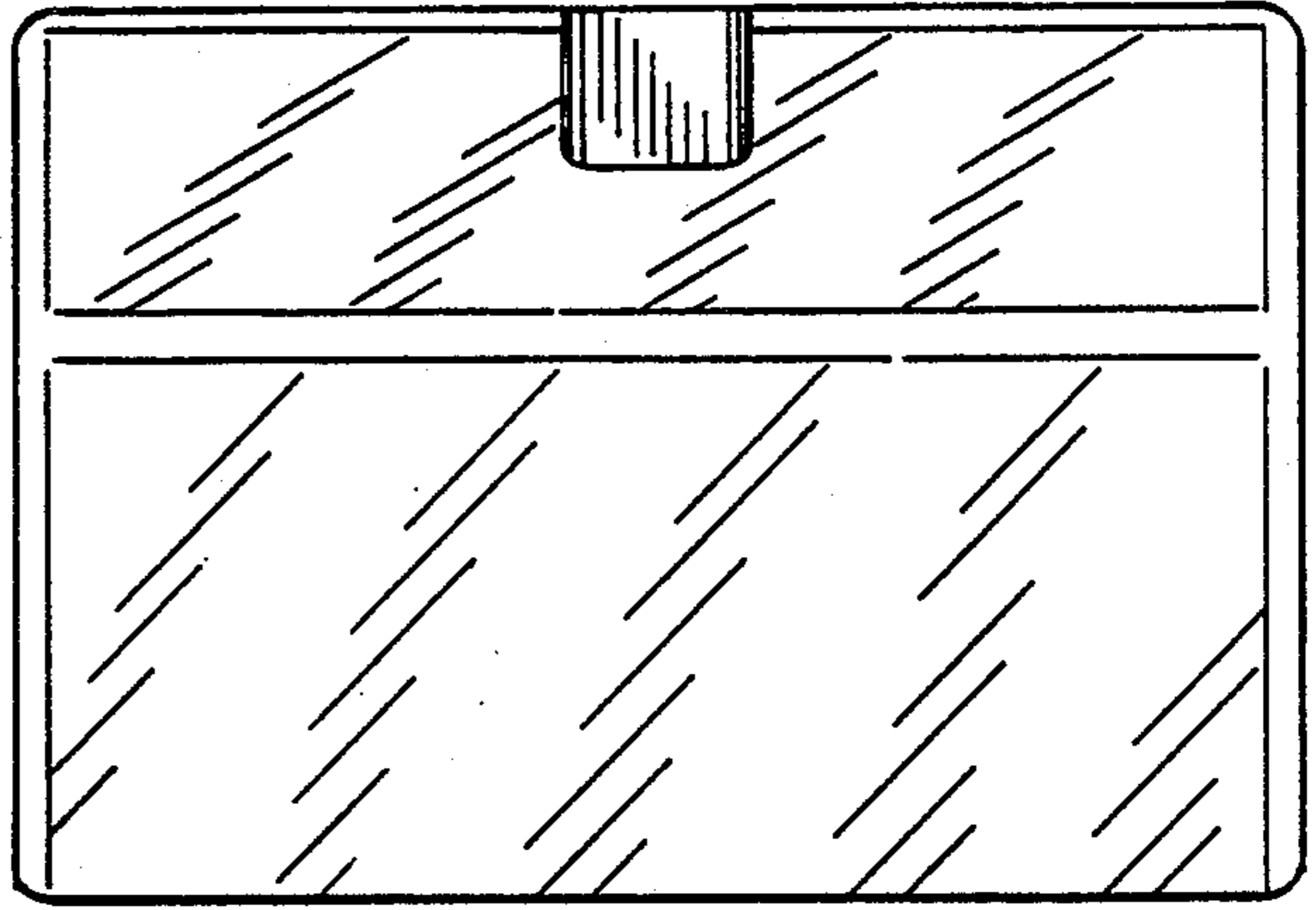

FIG. 15

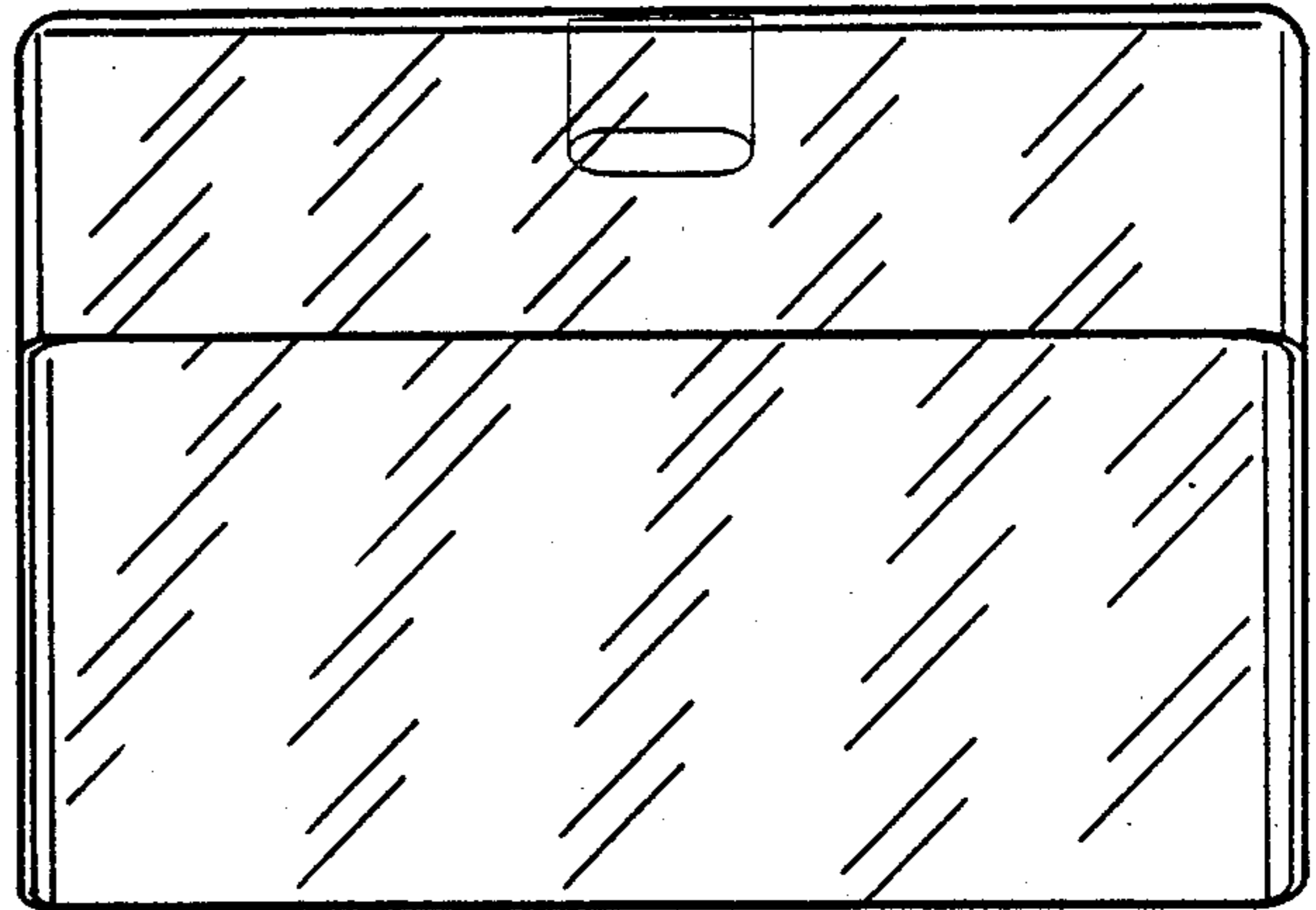

FIG. 16

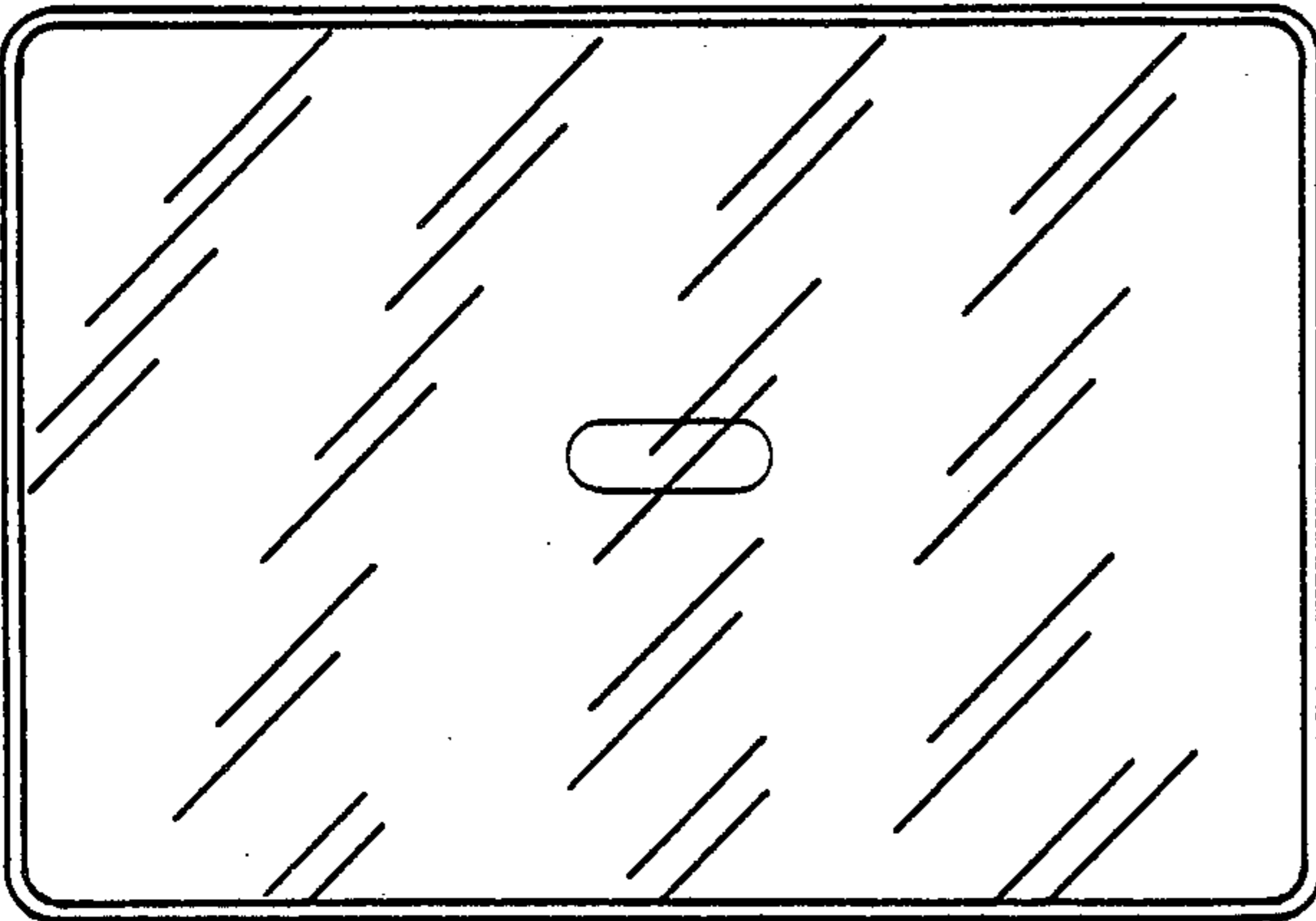

FIG. 18

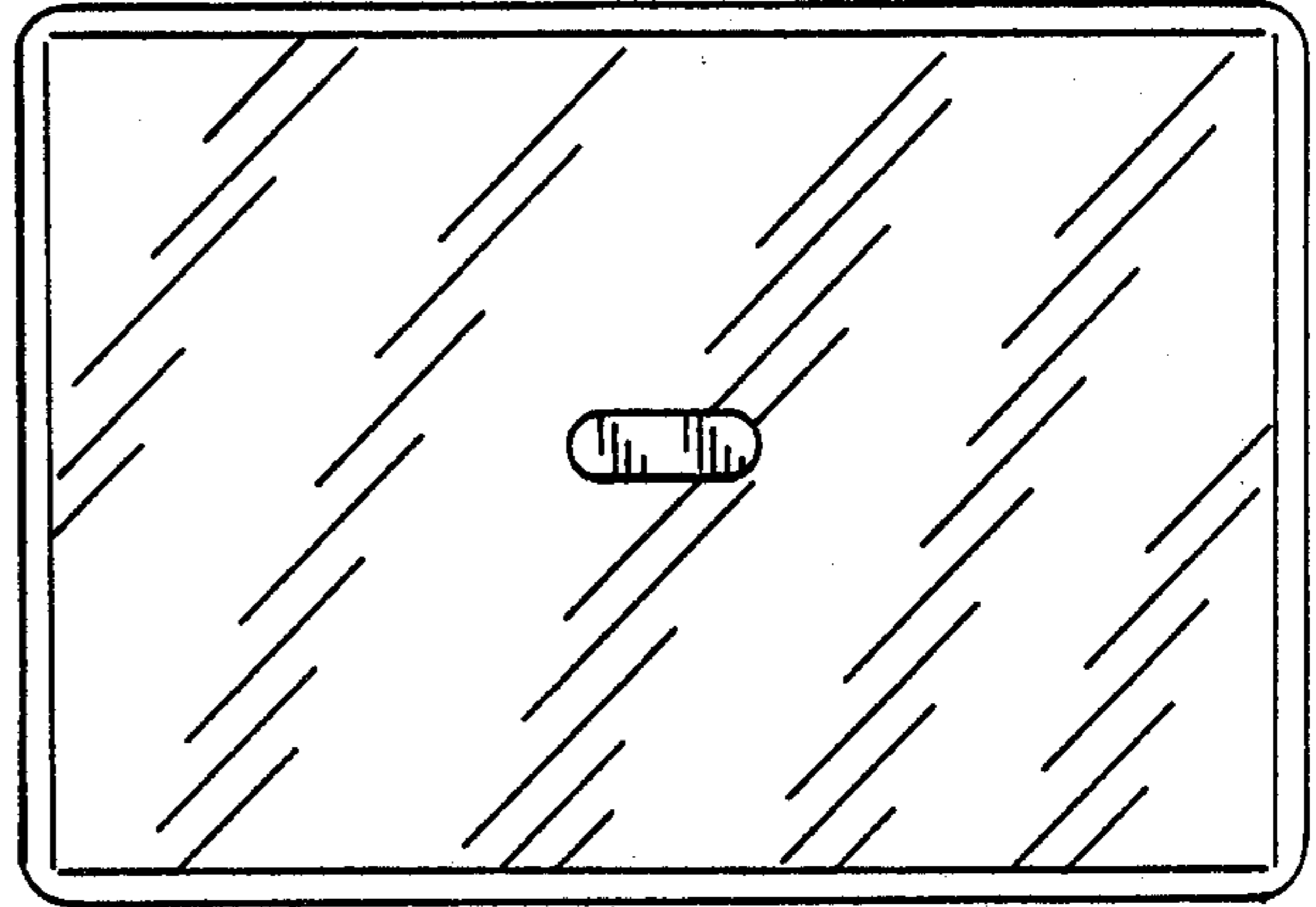

FIG. 17