

United States Patent [19]

Hegemann et al.

[11] Patent Number: **Des. 295,787**

[45] Date of Patent: **** May 17, 1988**

[54] **NASAL SPRAY DISPENSER**

[76] Inventors: **Manfred K. Hegemann**, 10 Ferris La., South Nyack, N.Y. 10960; **Edward J. Drozd, Jr.**, 10 Maureen Ct., Lake Hiawatha, N.J. 07034

[**] Term: **14 Years**

[21] Appl. No.: **733,019**

[22] Filed: **May 13, 1985**

[52] U.S. Cl. **D24/62; D24/62**

[58] Field of Search **D24/62, 63, 51; 128/200.14, 200.18, 200.23, 203.15, 203.24; 222/103, 105**

[56] **References Cited**

U.S. PATENT DOCUMENTS

D. 191,251 8/1961 Zackheim D24/63
D. 207,143 3/1967 Goodwin D24/62

D. 237,017 9/1975 Beaufour D24/62
2,906,265 9/1959 Samuels 128/200.23
4,353,365 10/1982 Hallworth et al. 128/203.15

Primary Examiner—A. Hugo Word
Assistant Examiner—Stella M. Reid

[57] **CLAIM**

The ornamental design for a nasal spray dispenser, as shown.

DESCRIPTION

FIG. 1 is a perspective view of a nasal spray dispenser showing our new design;
FIG. 2 is a side elevational view thereof;
FIG. 3 is a side elevational view thereof, opposite that shown in FIG. 2;
FIG. 4 is a top plan view thereof;
FIG. 5 is a bottom plan view thereof;
FIG. 6 is a front elevational view thereof, and
FIG. 7 is a rear elevational view thereof.

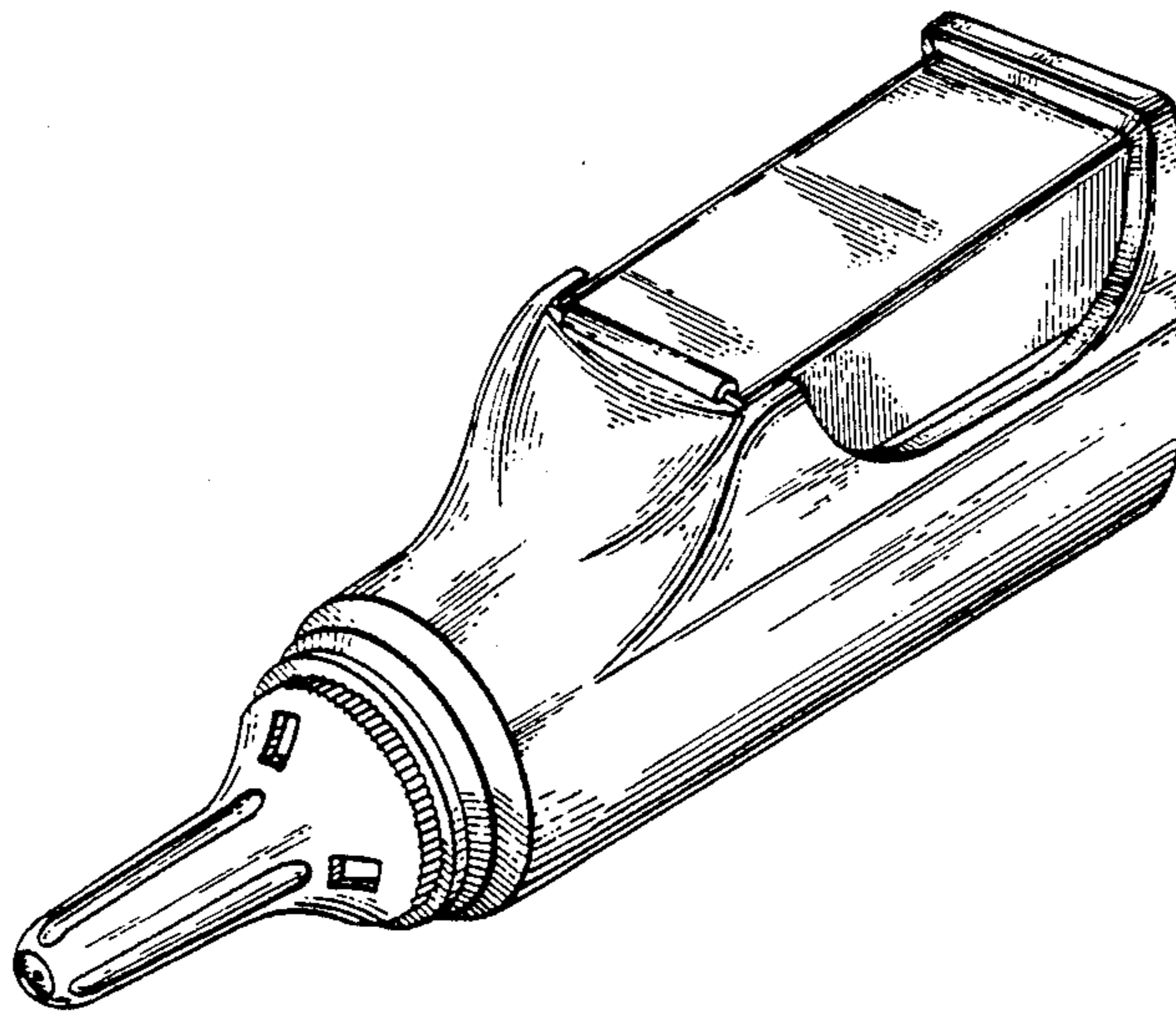

FIG. 1

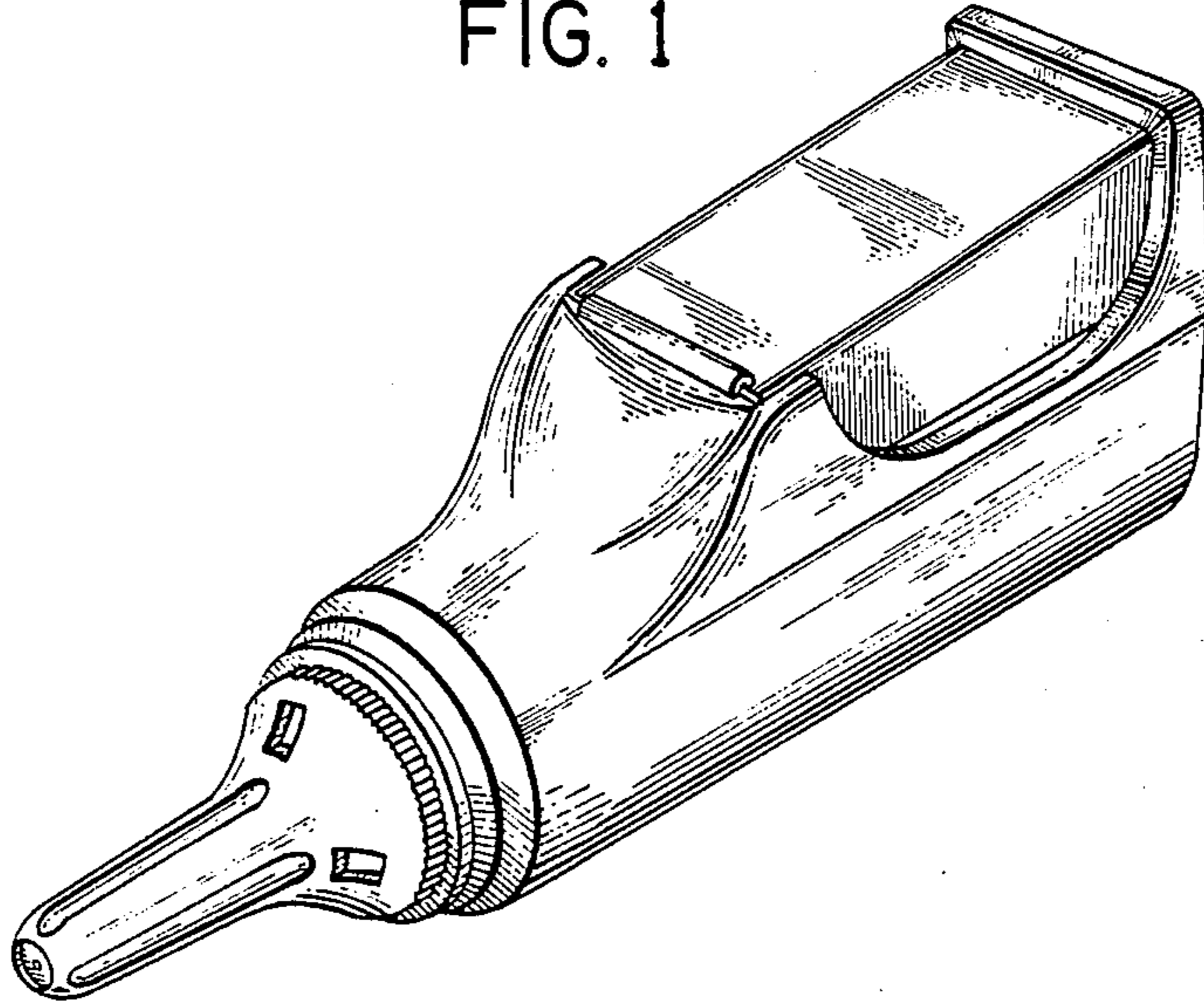

FIG. 2

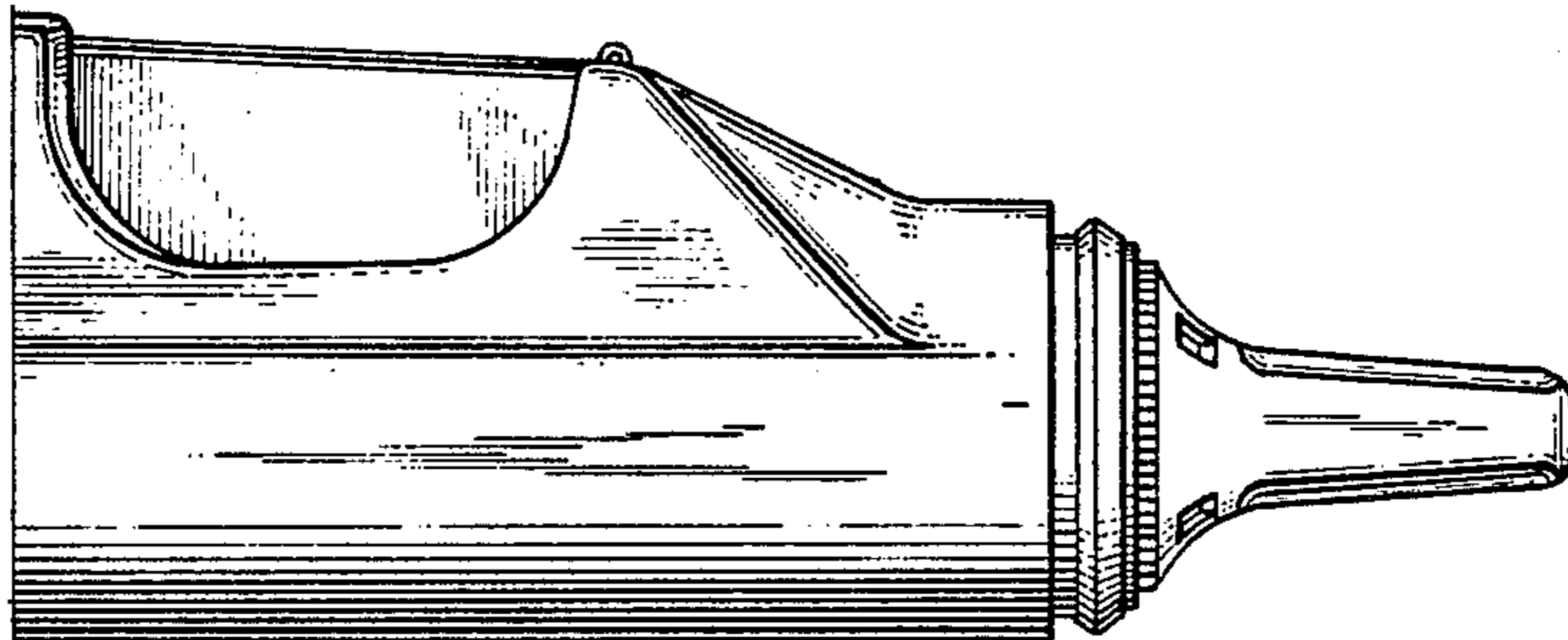

FIG. 3

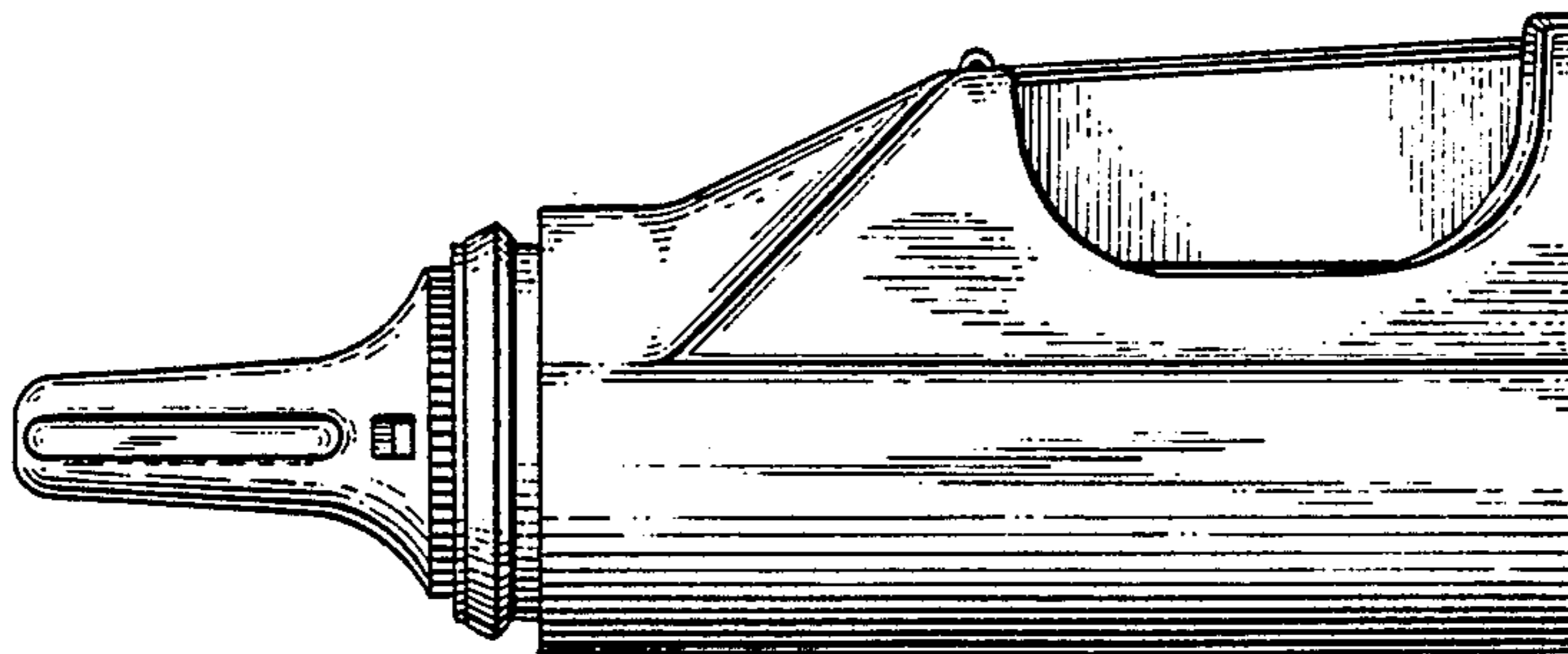

FIG. 4

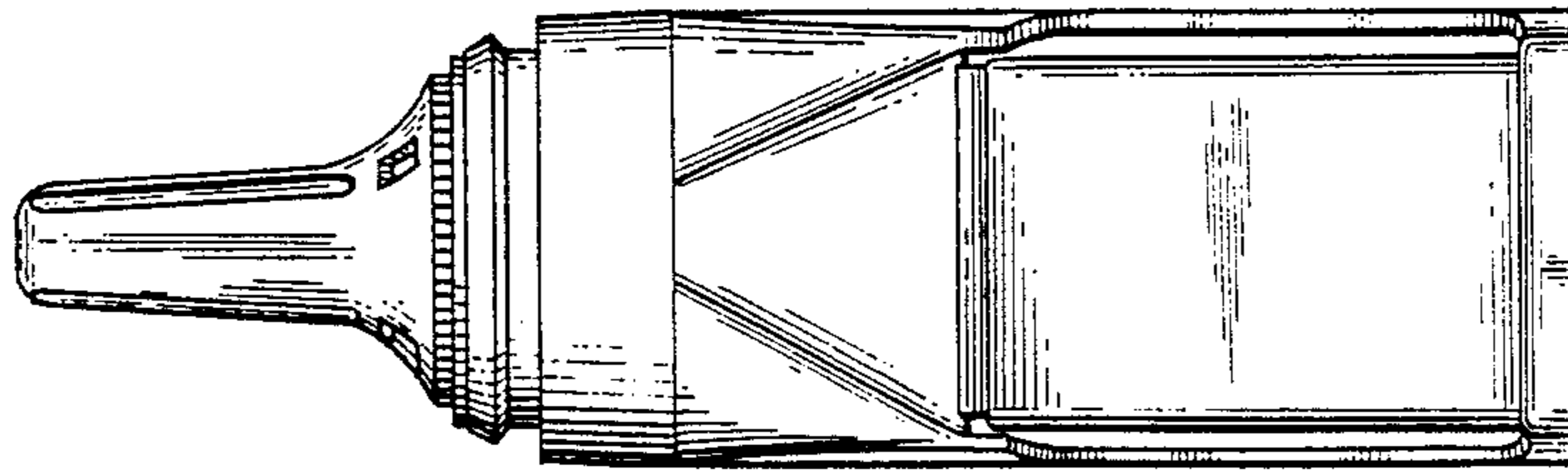

FIG. 5

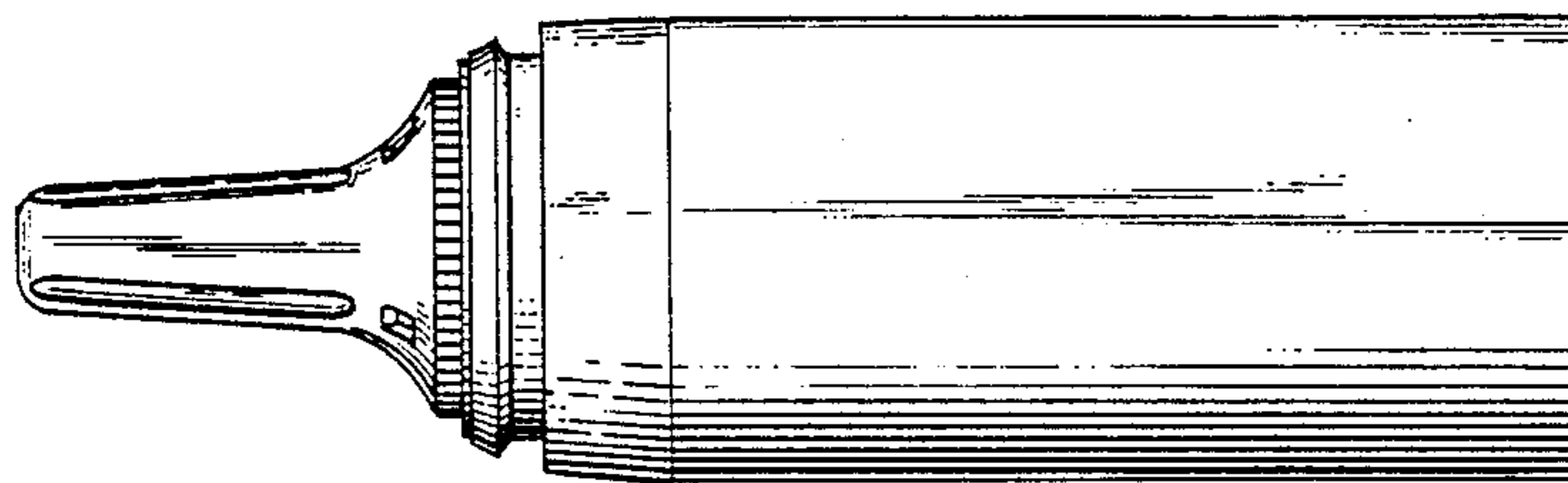

FIG. 6

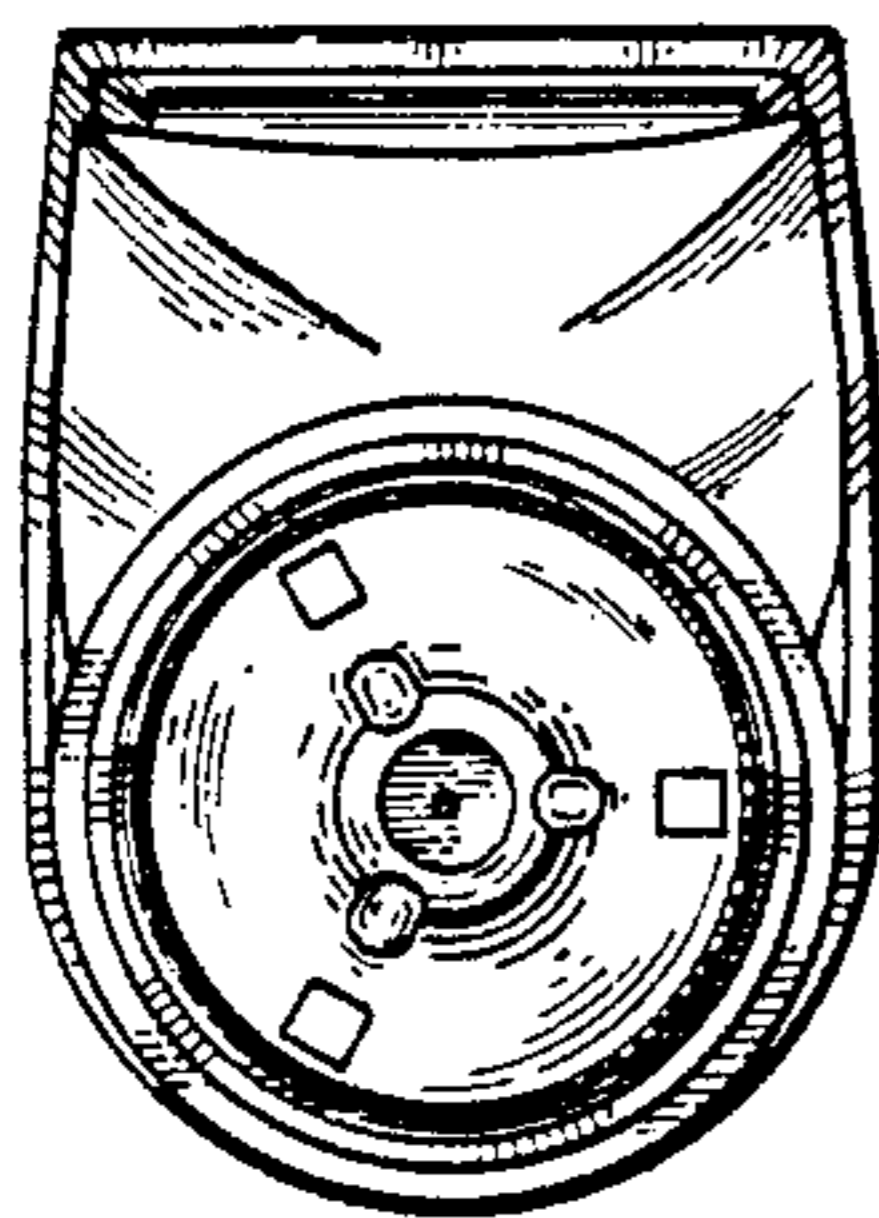

FIG. 7

