

[54] **SPEAKER**

[75] Inventor: **Shu Takahara, Tokyo, Japan**

[73] Assignee: **Pioneer Electronic Corporation, Tokyo, Japan**

[**] Term: **14 Years**

[21] Appl. No.: **744,877**

[22] Filed: **Jun. 17, 1985**

[30] **Foreign Application Priority Data**

Jan. 19, 1985 [JP] Japan 60-1527

[52] U.S. Cl. **D14/30; D14/34**

[58] Field of Search **D14/30-37, D14/39; 381/90; 181/148, 150, 157, 199**

[56] **References Cited**

U.S. PATENT DOCUMENTS

- D. 281,157 10/1985 Takagi D14/30
- D. 281,596 12/1985 Iijima D14/30

- D. 284,002 5/1986 Takagi D14/30
- D. 289,282 4/1987 Ohtsuji et al. D14/34 X
- D. 290,698 7/1987 Takagi D14/34 X

Primary Examiner—Louis S. Zarfes
Assistant Examiner—Theodore M. Shooman
Attorney, Agent, or Firm—Sughrue, Mion, Zinn, Macpeak, and Seas

[57] **CLAIM**

The ornamental design for a speaker, as shown.

DESCRIPTION

FIG. 1 is a front elevational view of a speaker showing my new design;
FIG. 2 is a rear elevational view thereof;
FIG. 3 is a right side elevational view thereof;
FIG. 4 is a left side elevational view thereof;
FIG. 5 is a top plan view thereof;
FIG. 6 is a bottom plan view thereof; and
FIG. 7 is a front, bottom and right side perspective view thereof.

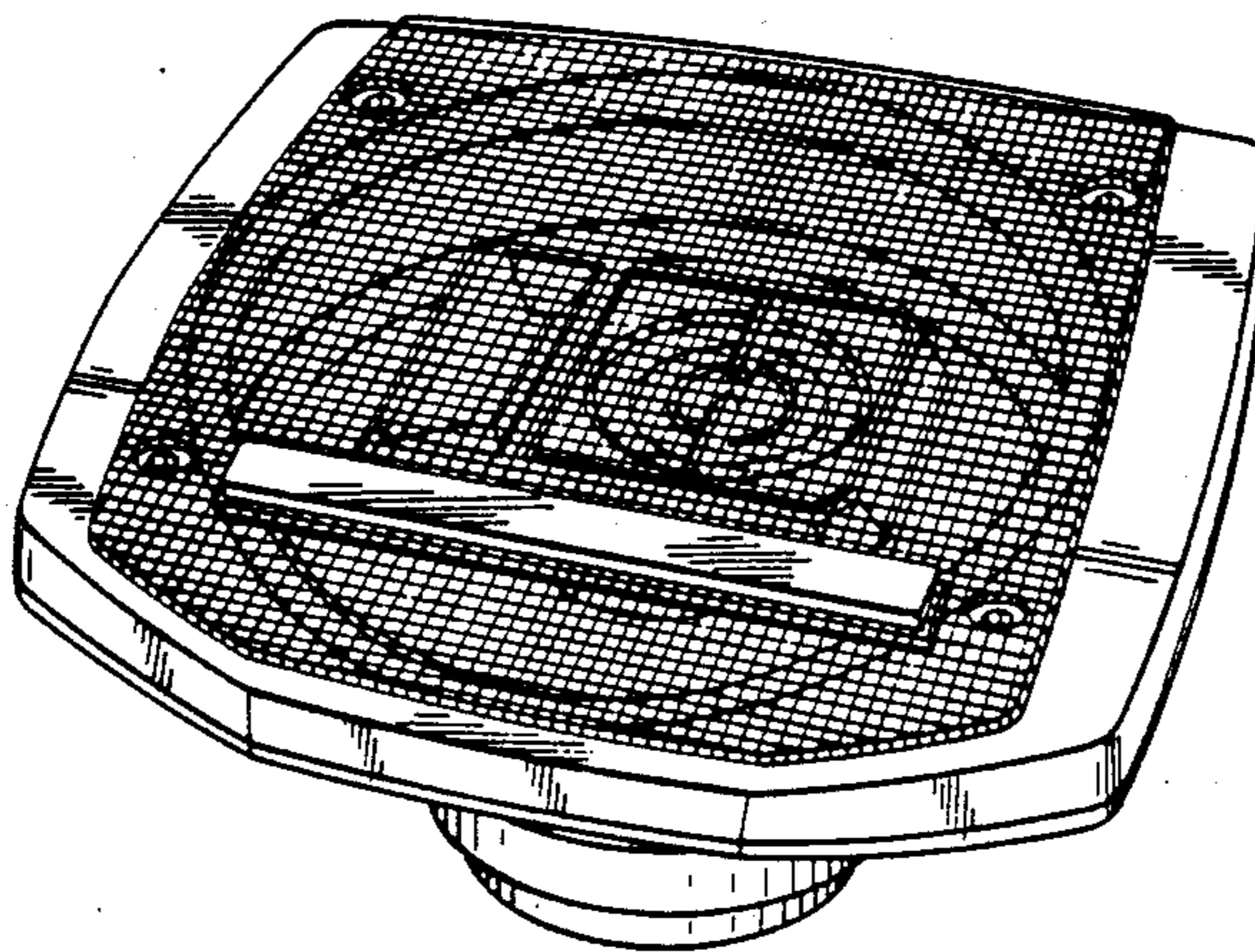

FIG. 1

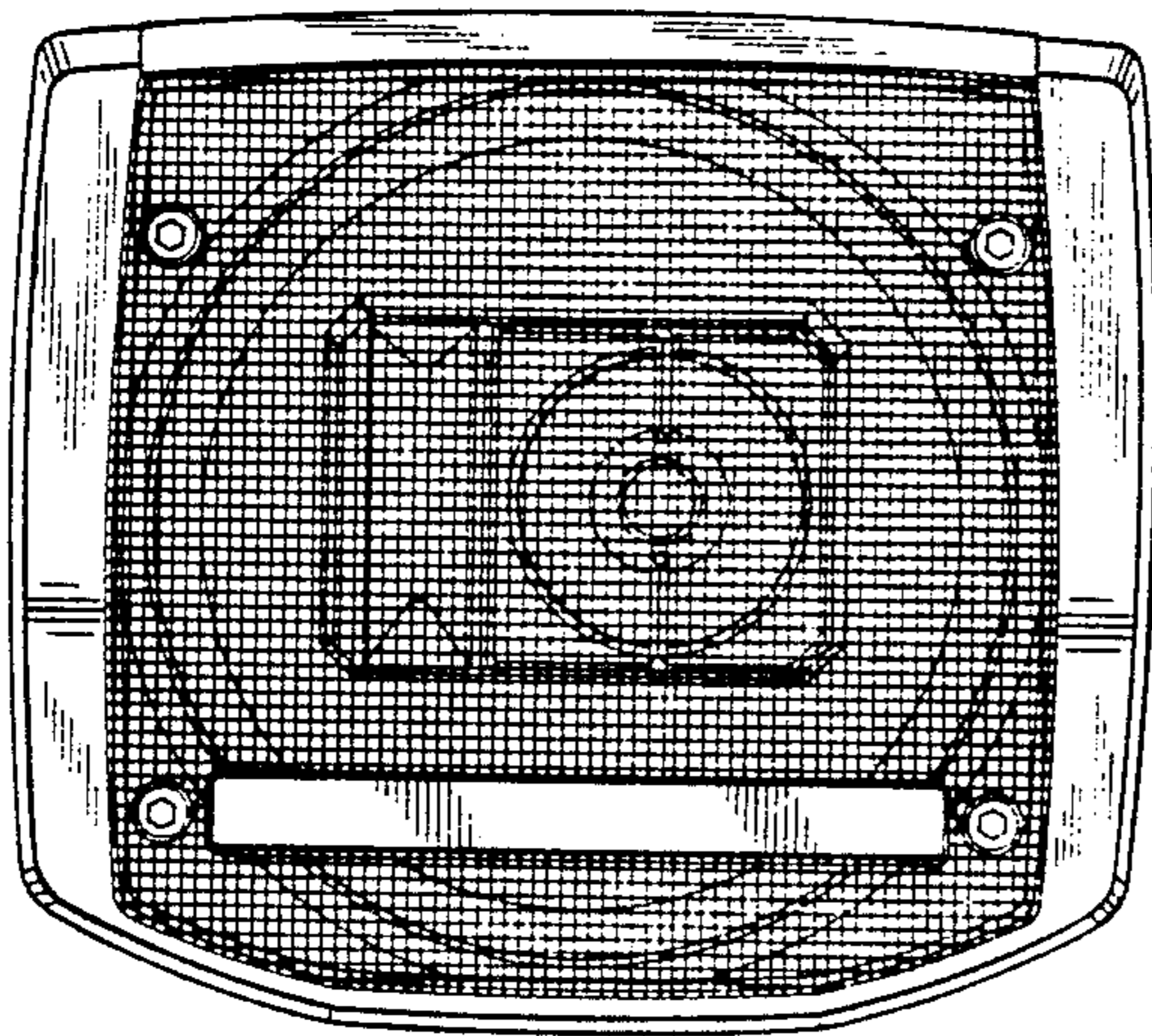

FIG. 3

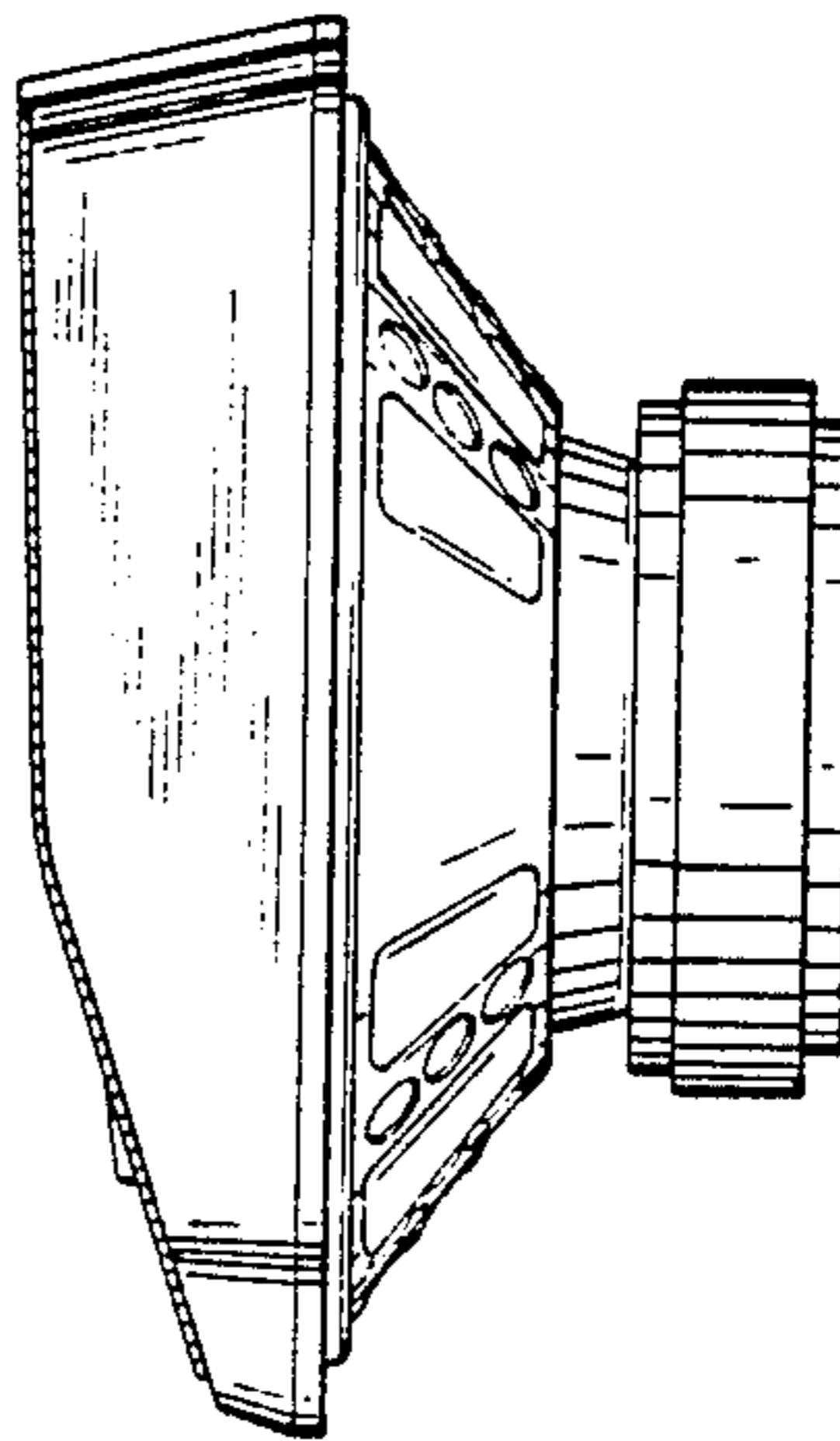

FIG. 2

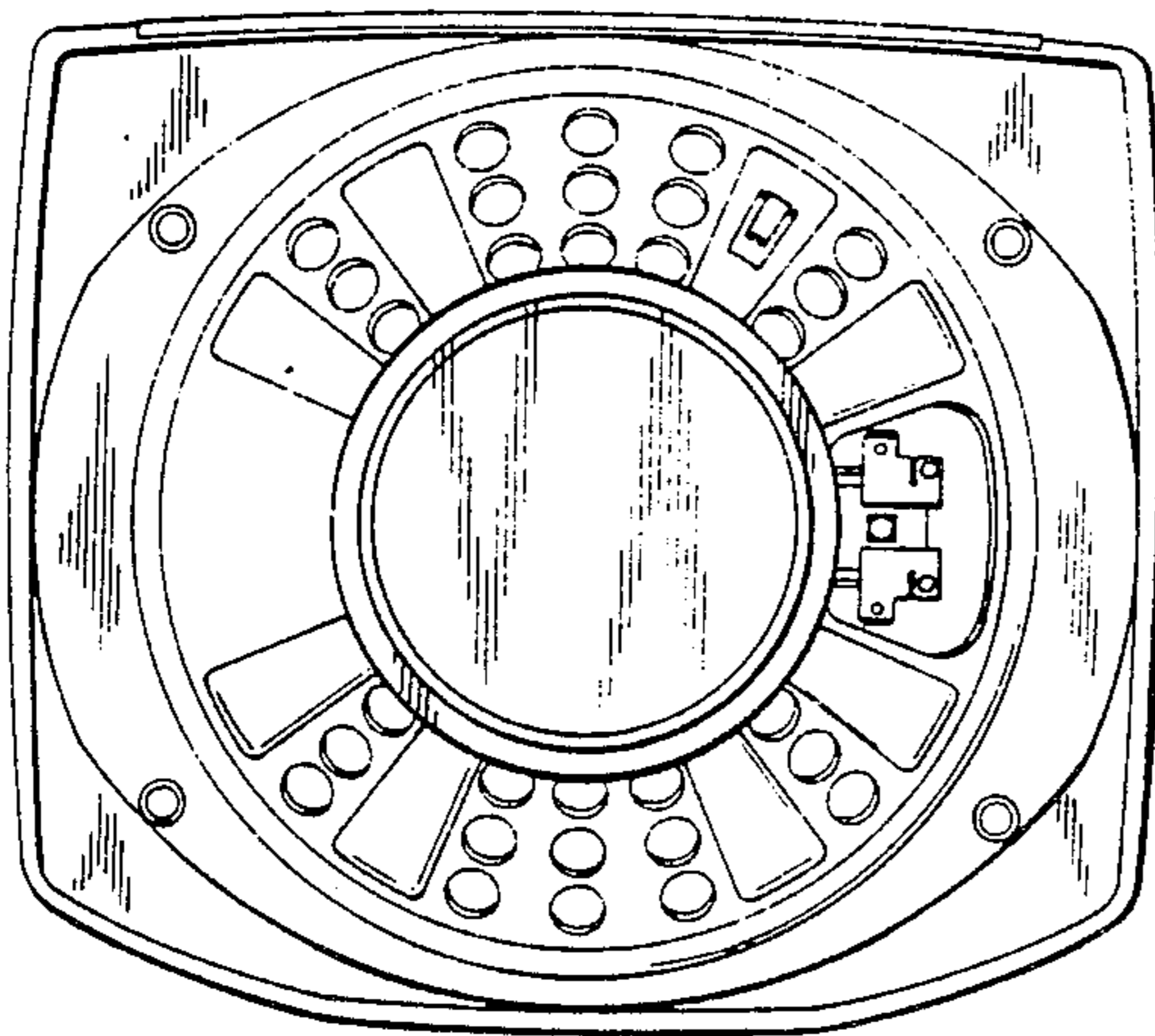

FIG. 4

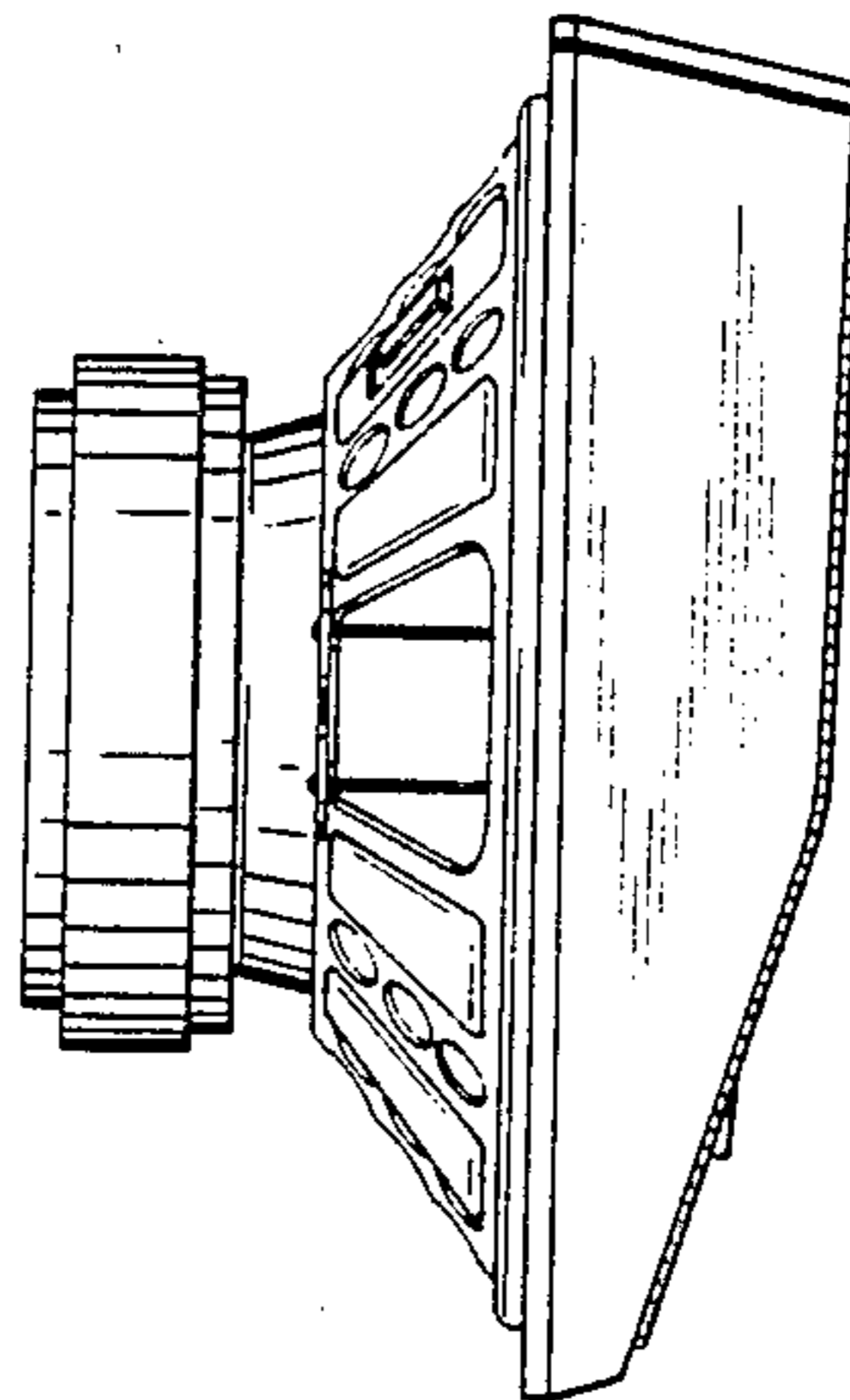

FIG. 5

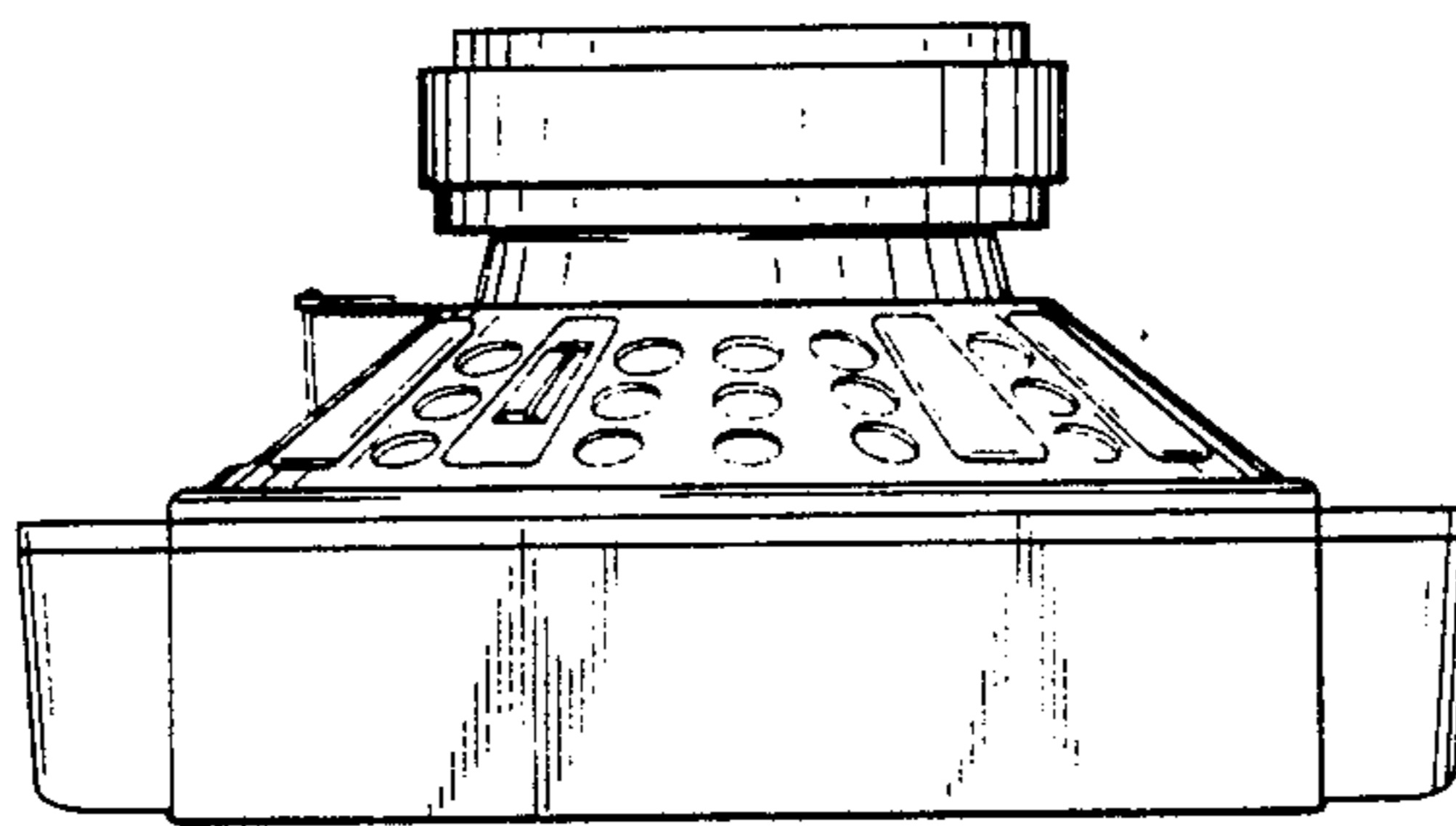

FIG. 6

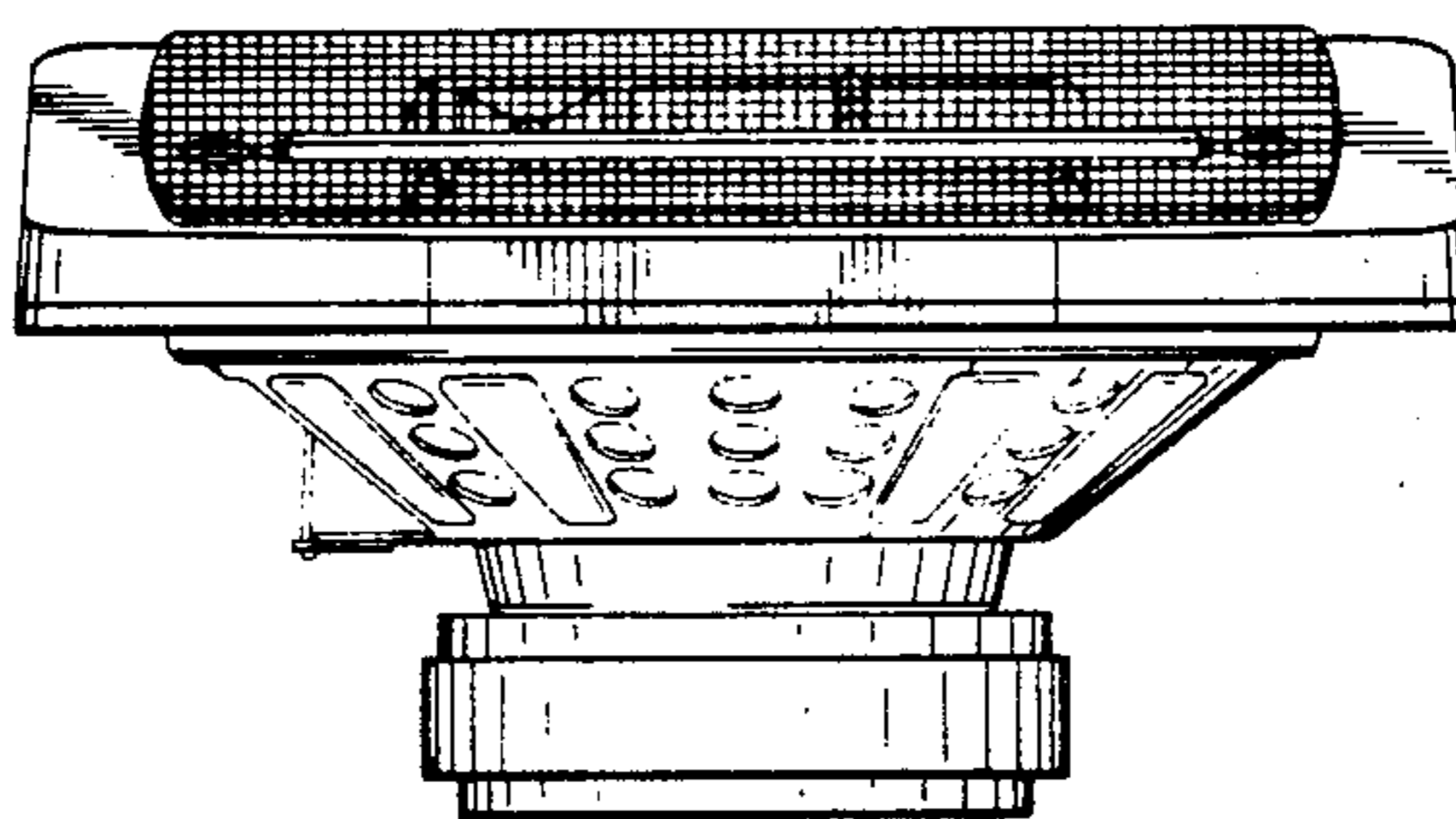

FIG. 7

