

[54] FILE ASSEMBLY

[75] Inventor: Mel Evenson, San Pedro, Calif.

[73] Assignee: Eldon Industries, Inc., Inglewood, Calif.

[**] Term: 14 Years

[21] Appl. No.: 715,345

[22] Filed: Mar. 25, 1985

[52] U.S. Cl. D19/90

[58] Field of Search D19/90-92, D19/75, 86; 211/87, 88

[56] References Cited

U.S. PATENT DOCUMENTS

D. 267,656	1/1983	Vevirit et al.	D19/91
D. 273,259	4/1984	Gullett	D19/91
D. 276,777	12/1984	Evenson	D19/91
3,747,776	7/1973	Gross	211/88

Primary Examiner—Charles A. Rademaker
Attorney, Agent, or Firm—Edward D. O'Brian

[57] CLAIM

The ornamental design for a file assembly, substantially as shown and described.

DESCRIPTION

FIG. 1 is a front elevational view of a file assembly showing my new design;
 FIG. 2 is a right side elevational view thereof;
 FIG. 3 is a rear elevational view thereof;
 FIG. 4 is a left side elevational view thereof;
 FIG. 5 is a top plan view thereof;
 FIG. 6 is a bottom plan view thereof;
 FIG. 7 is a front elevational view of a modified form of the design shown in FIGS. 1 through 6;
 FIG. 8 is another modified form of the design shown in FIGS. 1 through 6;
 FIG. 9 is a third modified form of the design shown in FIGS. 1 through 6;
 FIG. 10 is a front elevational view similar to what is shown in FIG. 1, but with the front panel member removed;
 FIG. 11 is a right side elevational view thereof;
 FIG. 12 is a rear elevational view thereof;
 FIG. 13 is a left side elevational view thereof;
 FIG. 14 is a top plan view thereof;
 FIG. 15 is a bottom plan view thereof;
 FIG. 16 is a front elevational view of the closure plate member of the design shown in FIGS. 1 through 6;
 FIG. 17 is a right side elevational view thereof;
 FIG. 18 is a top plan view thereof;
 FIG. 19 is a rear elevational view thereof;
 FIG. 20 is a left side elevational view thereof; and
 FIG. 21 is a perspective view of the design shown in FIGS. 10 through 15 shown on a reduced scale.

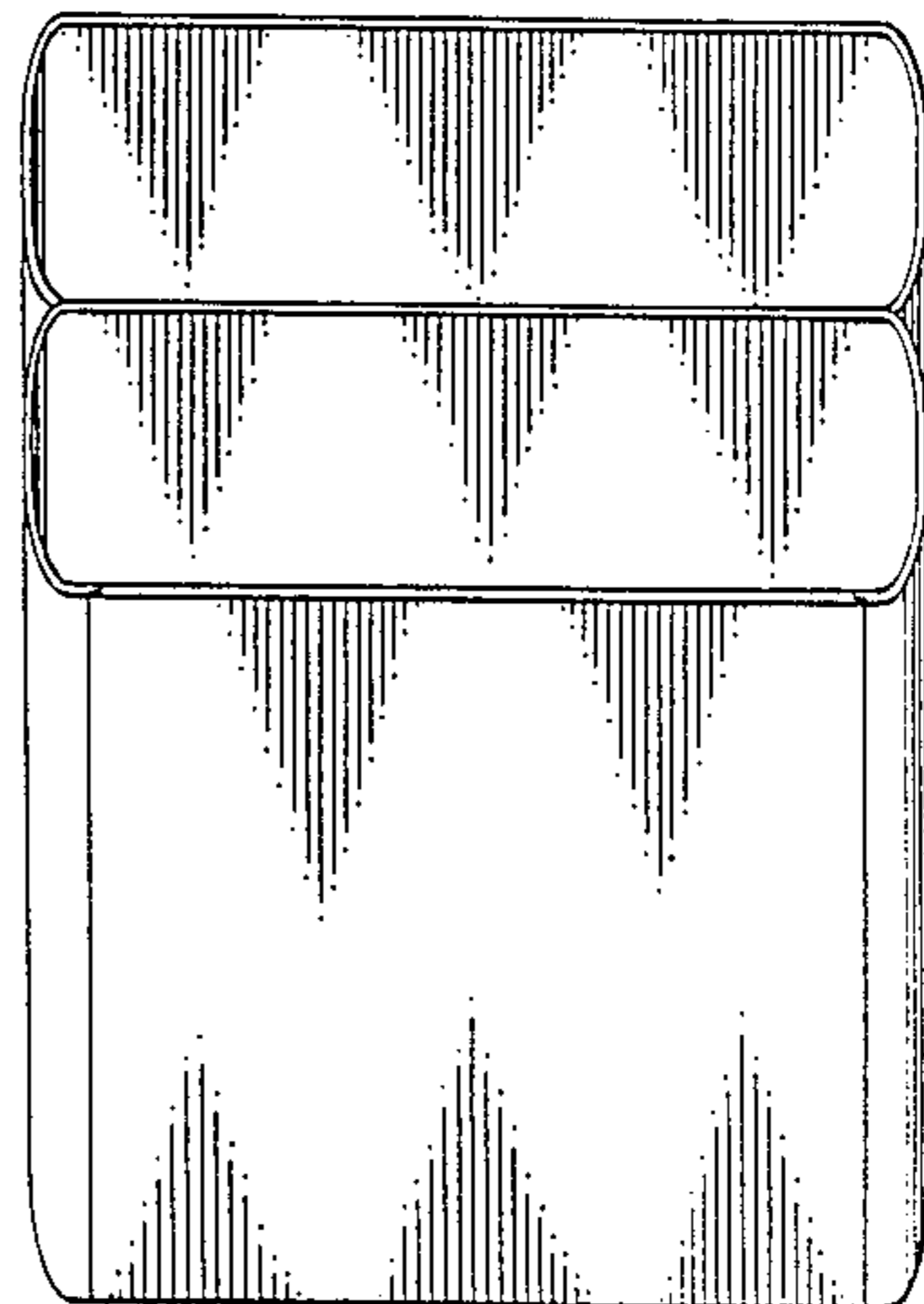
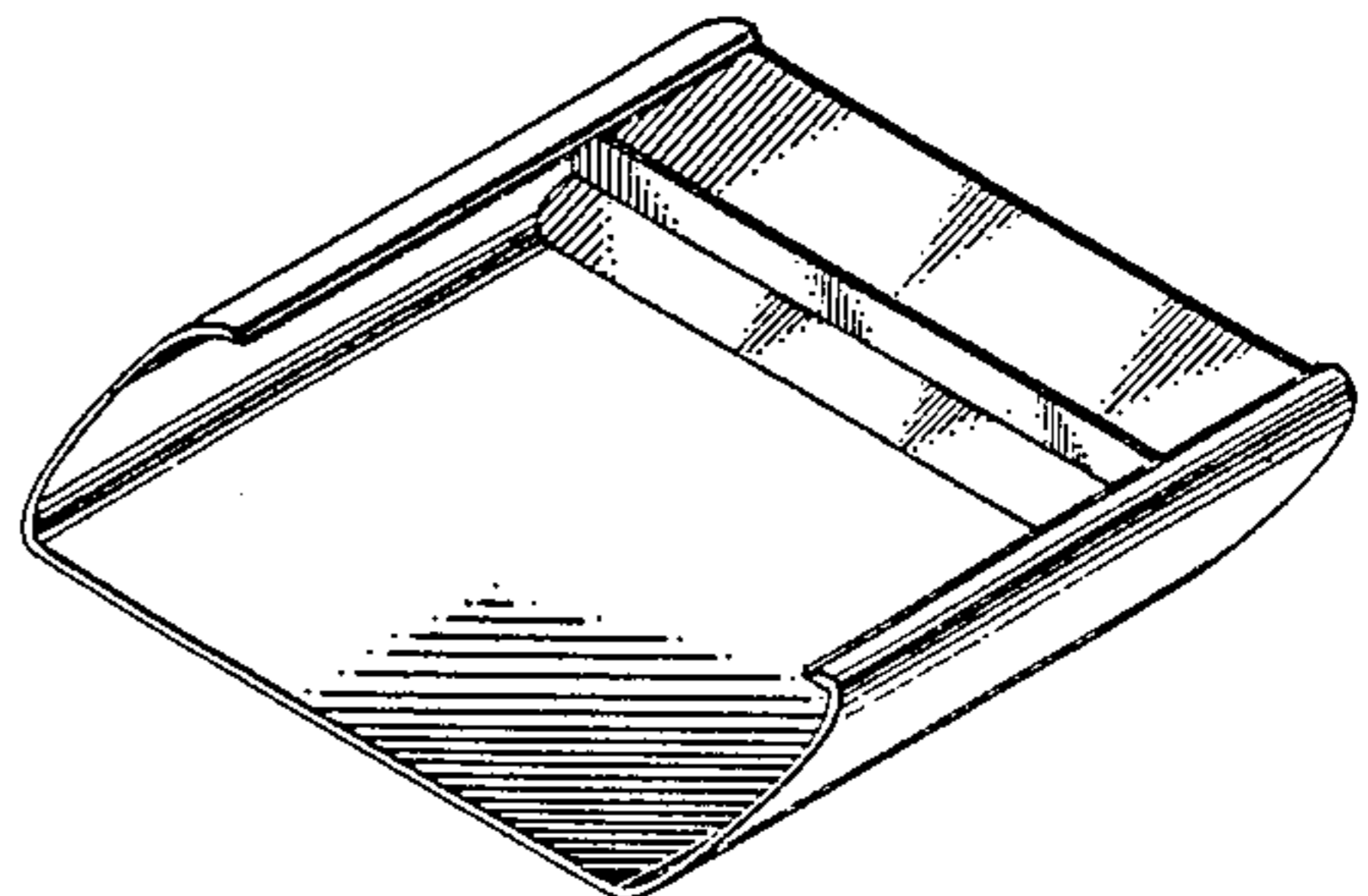
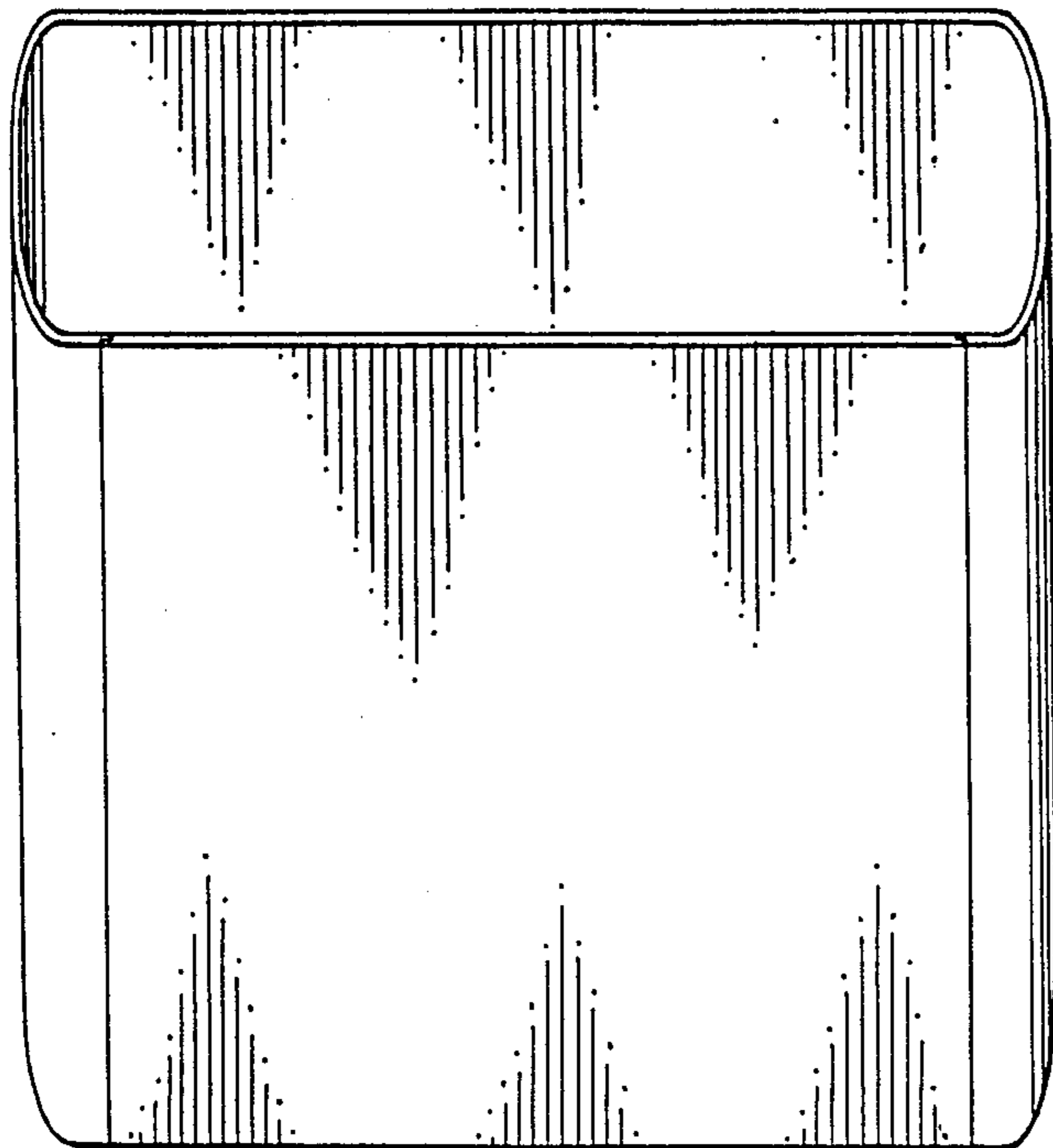

FIG. 1.

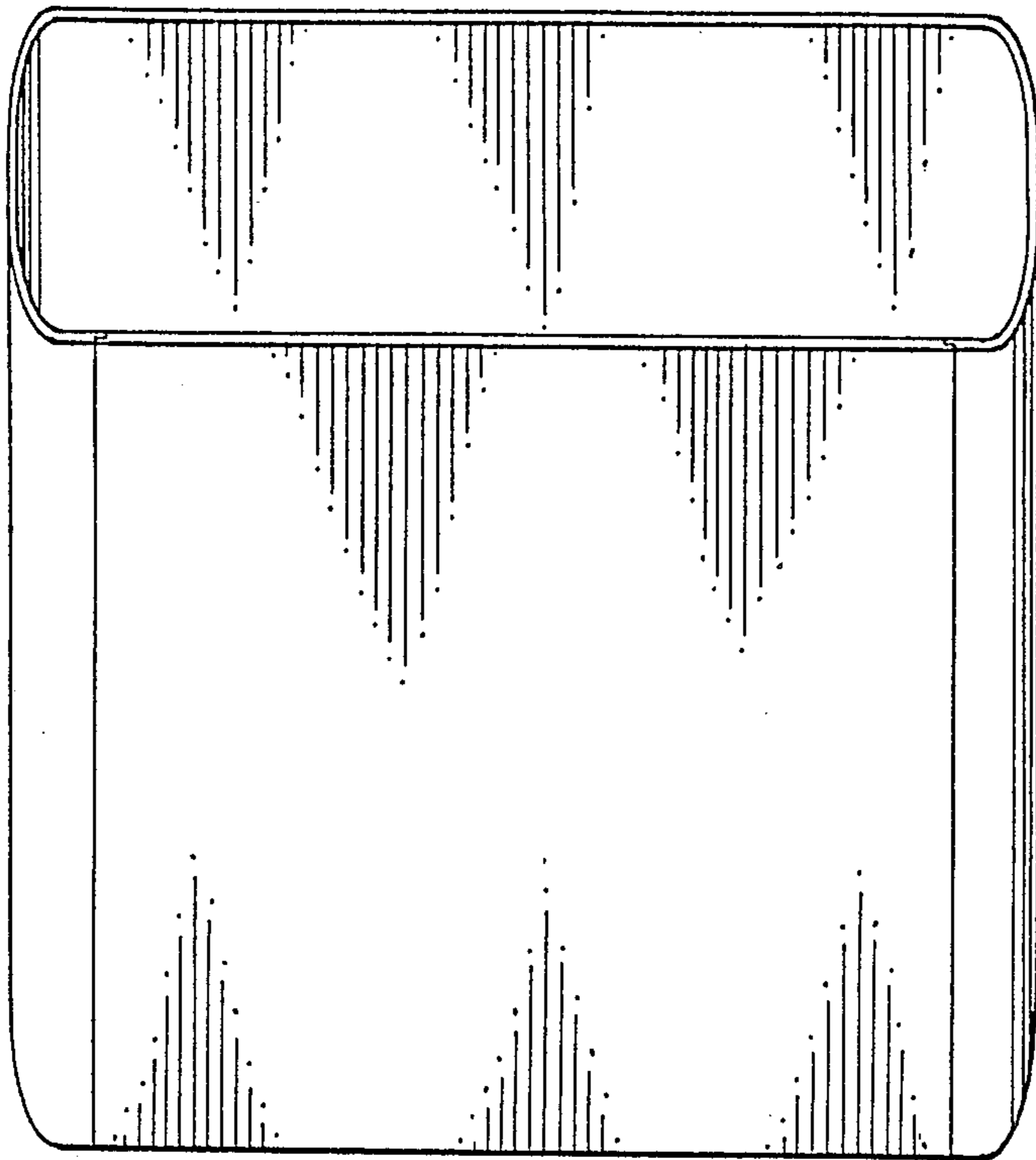

FIG. 2.

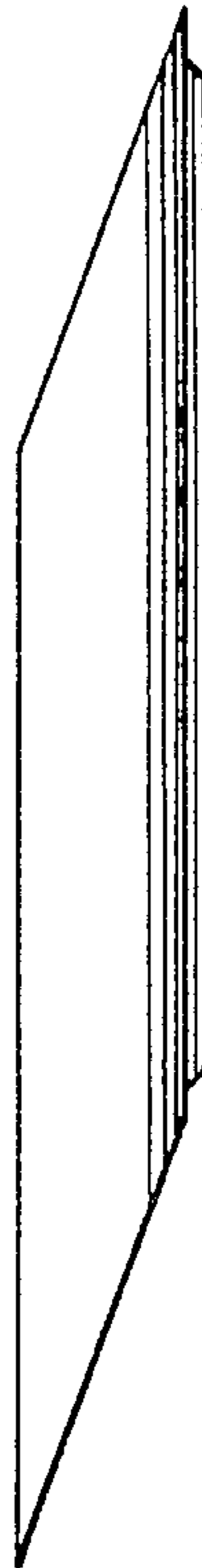

FIG. 3.

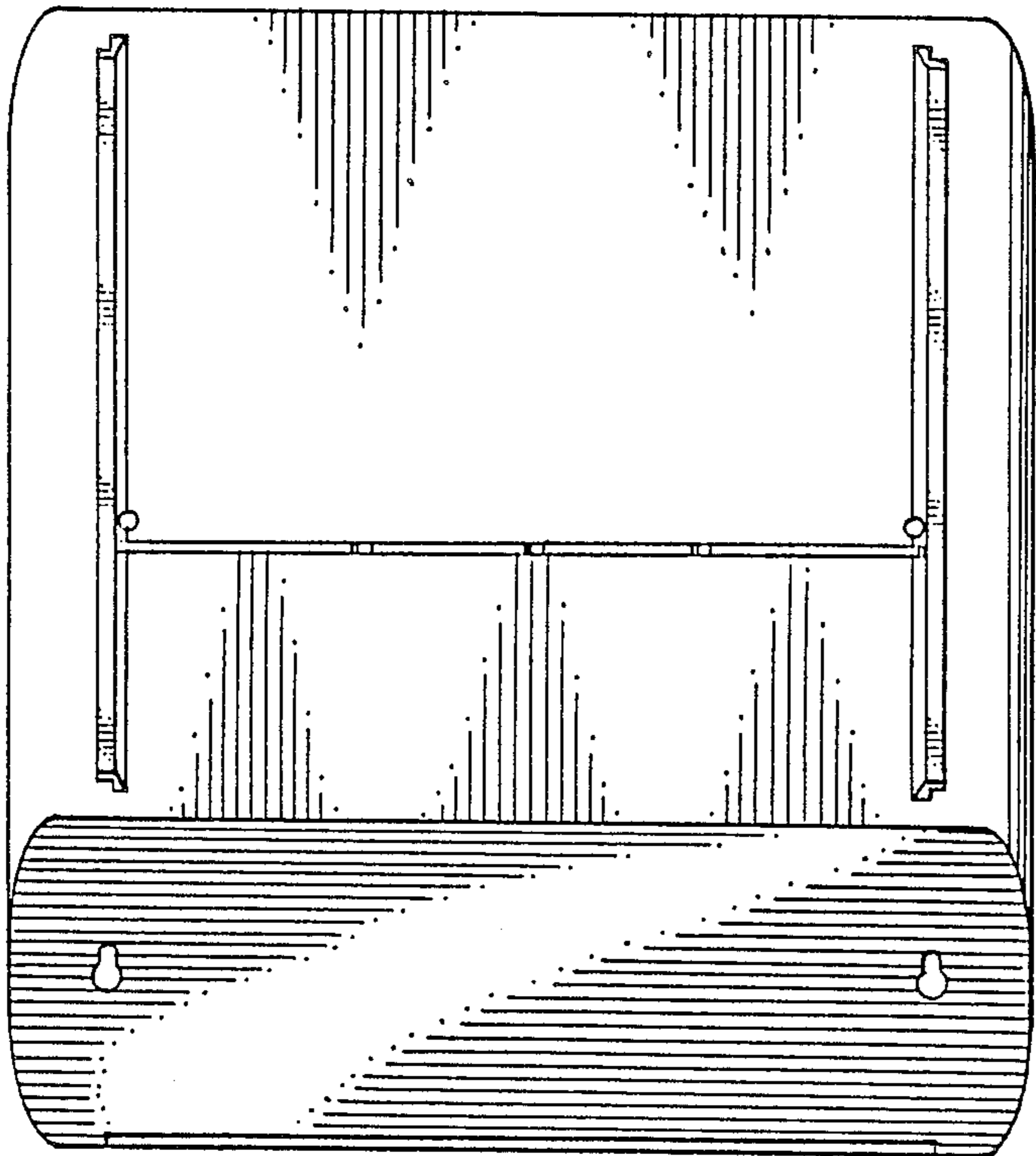

FIG. 4.

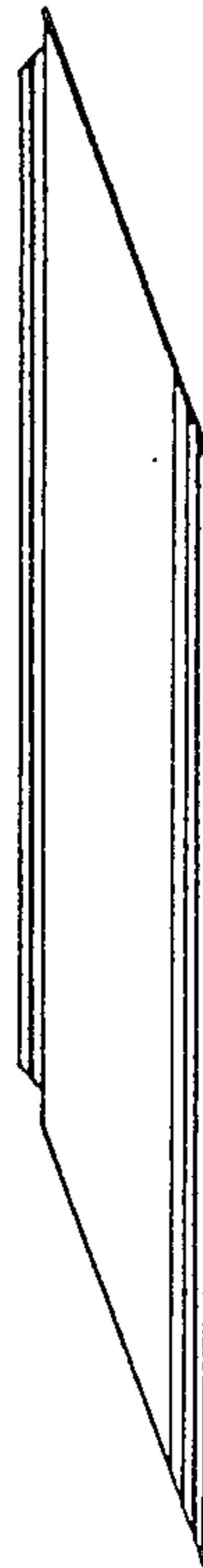

FIG. 5.



FIG. 6.

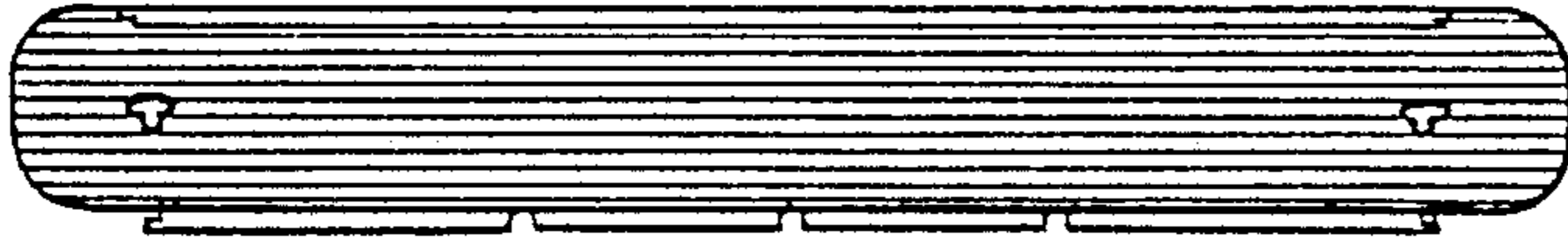

FIG. 8.

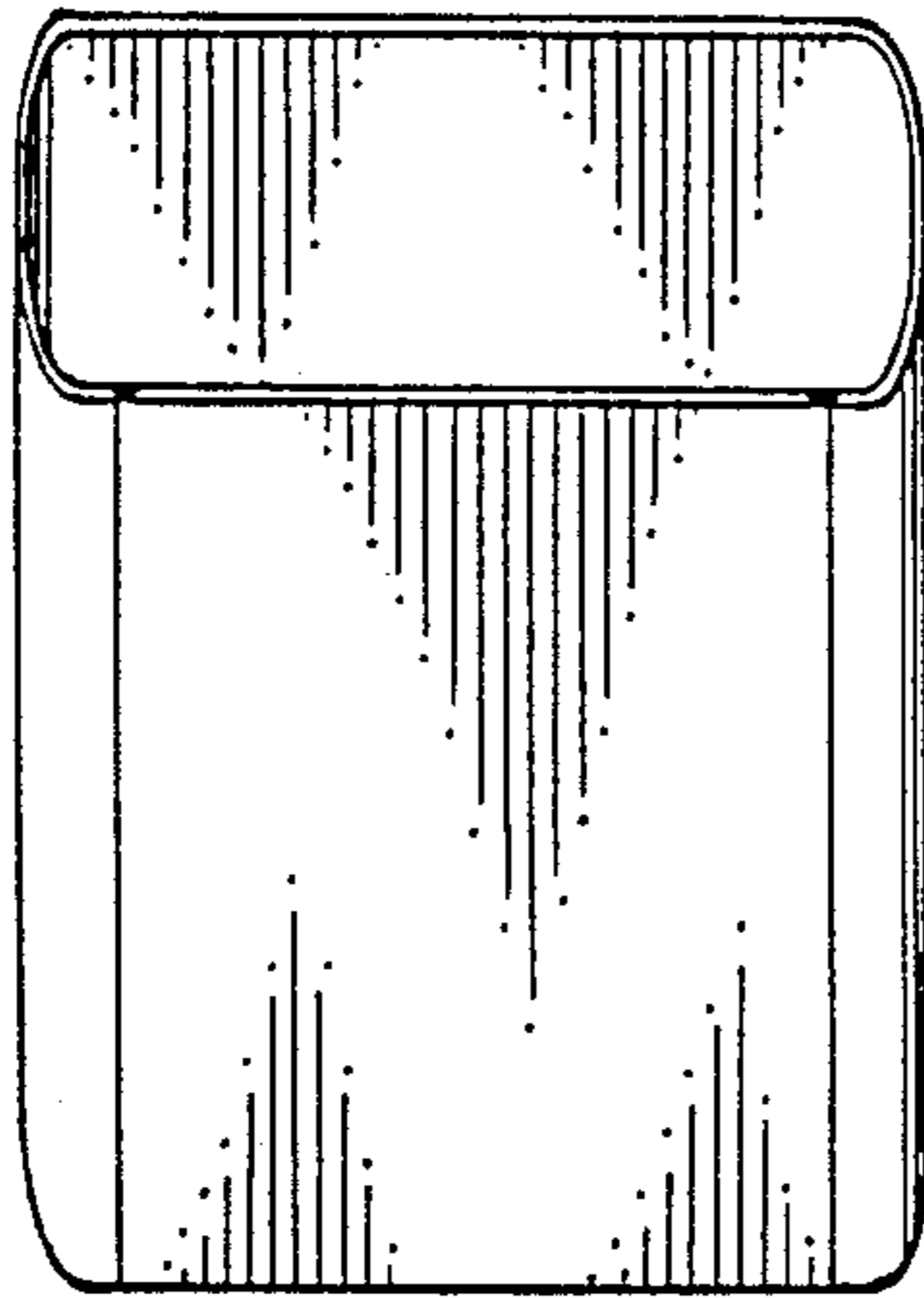

FIG. 9.

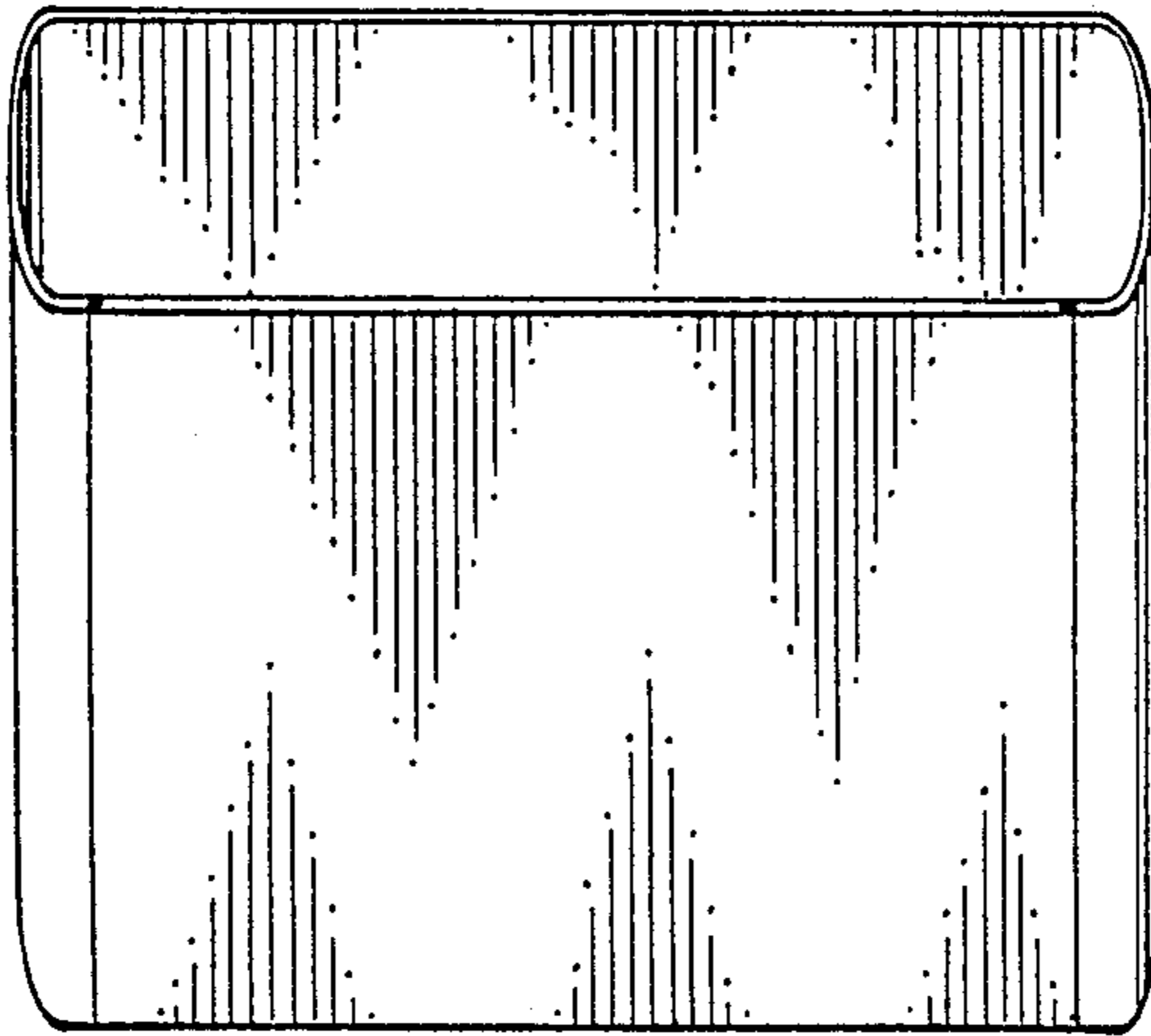

FIG. 10.

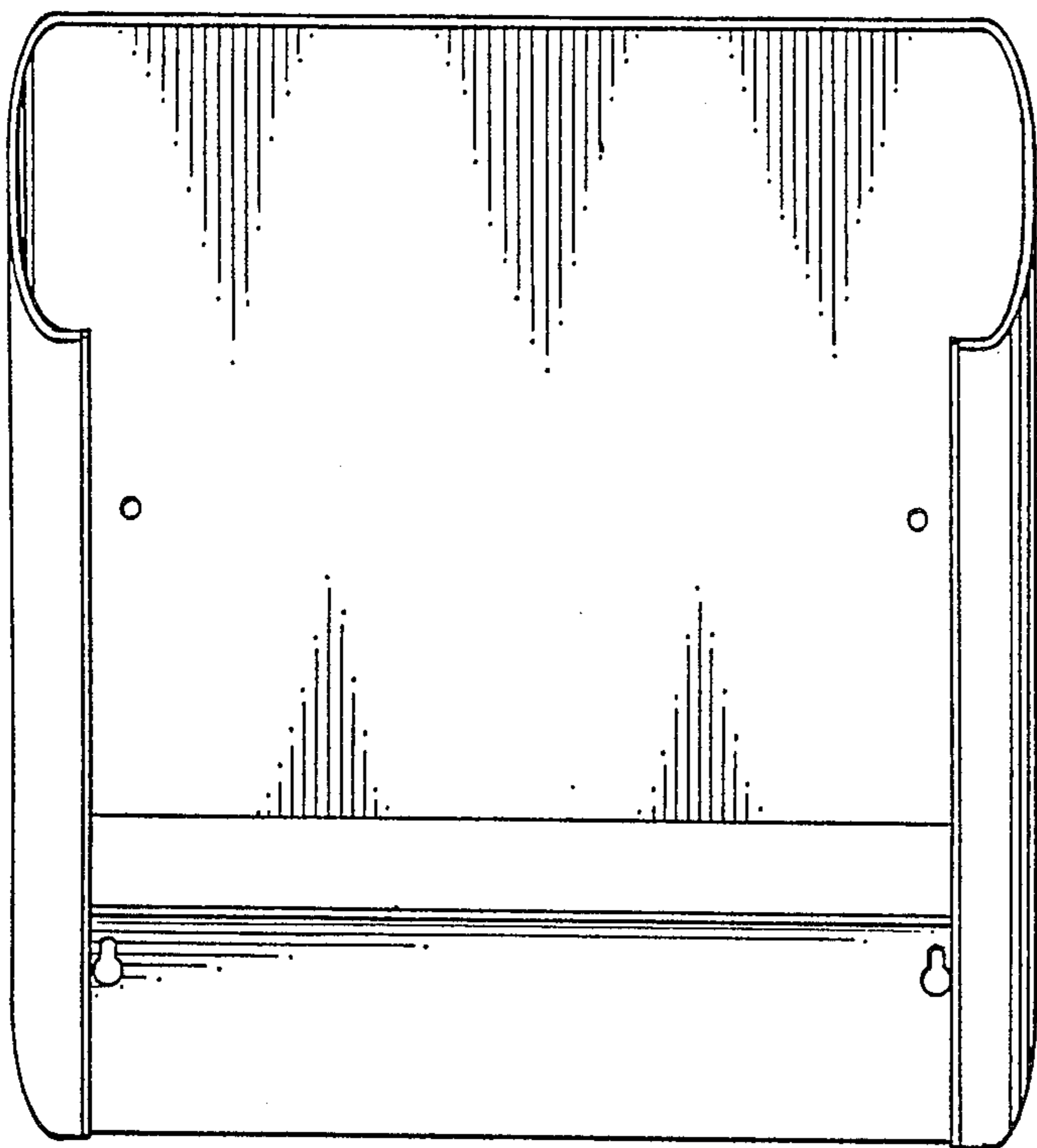

FIG. 11.



FIG. 12.

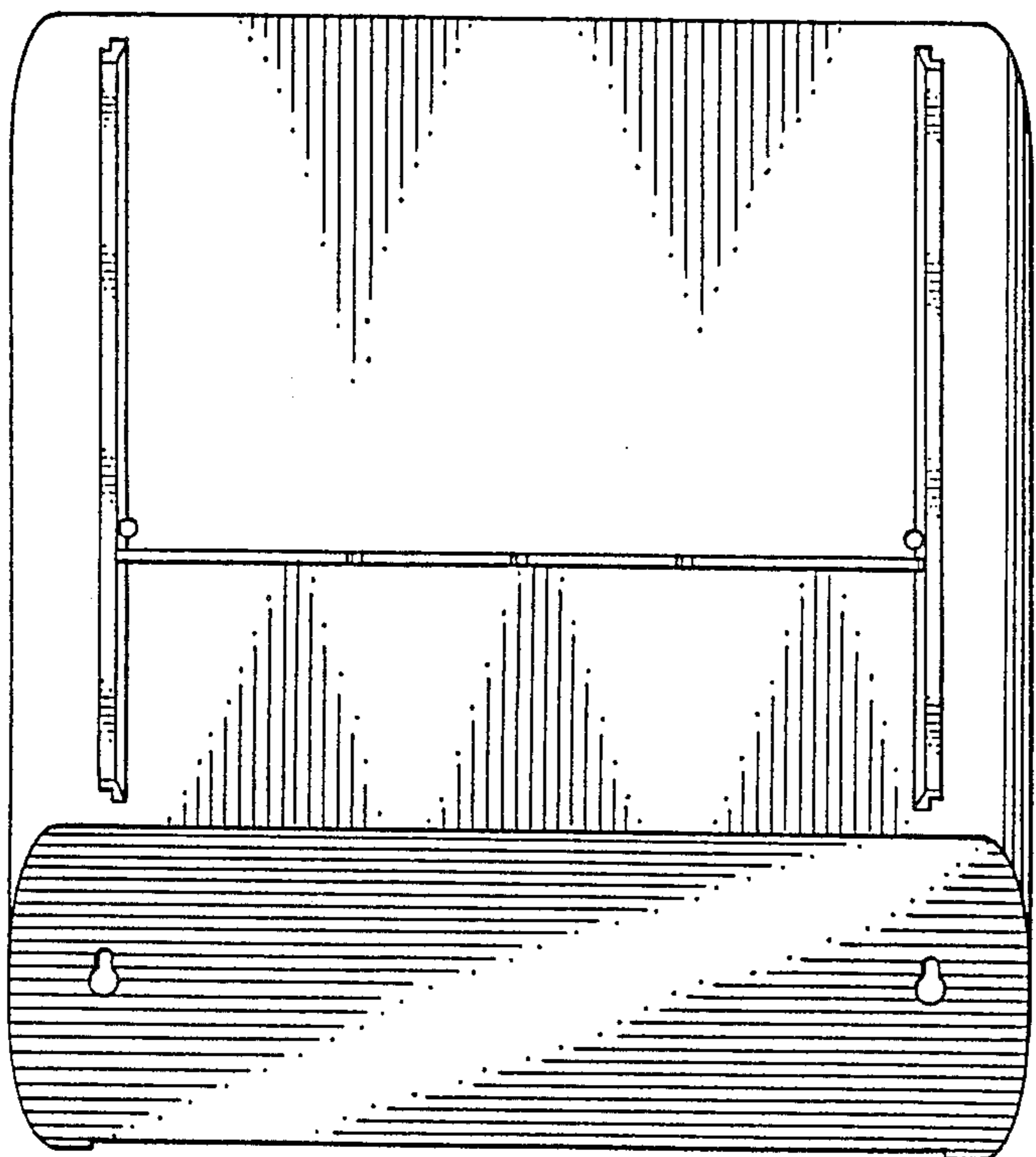

FIG. 13.



FIG. 14.

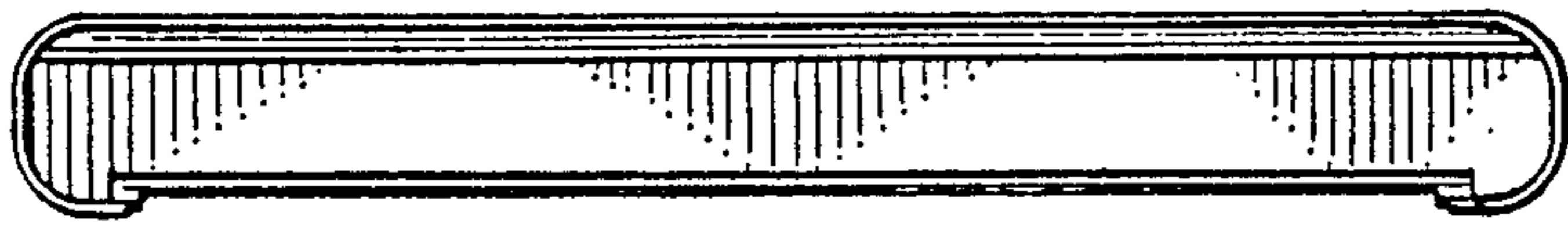

FIG. 15

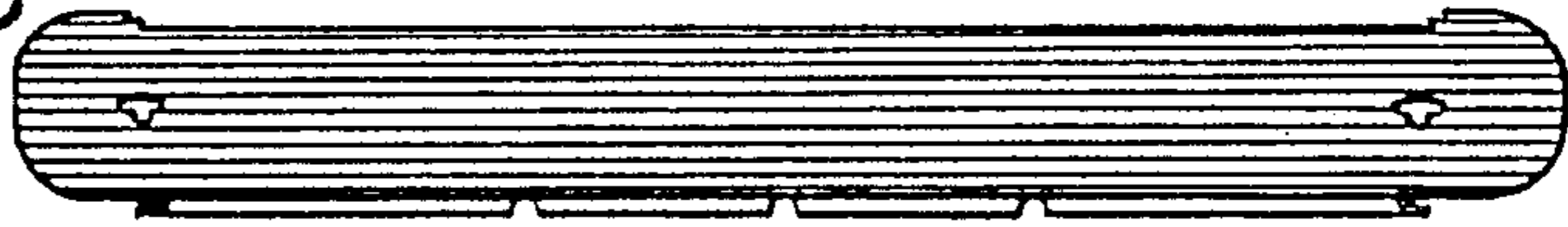

FIG. 16

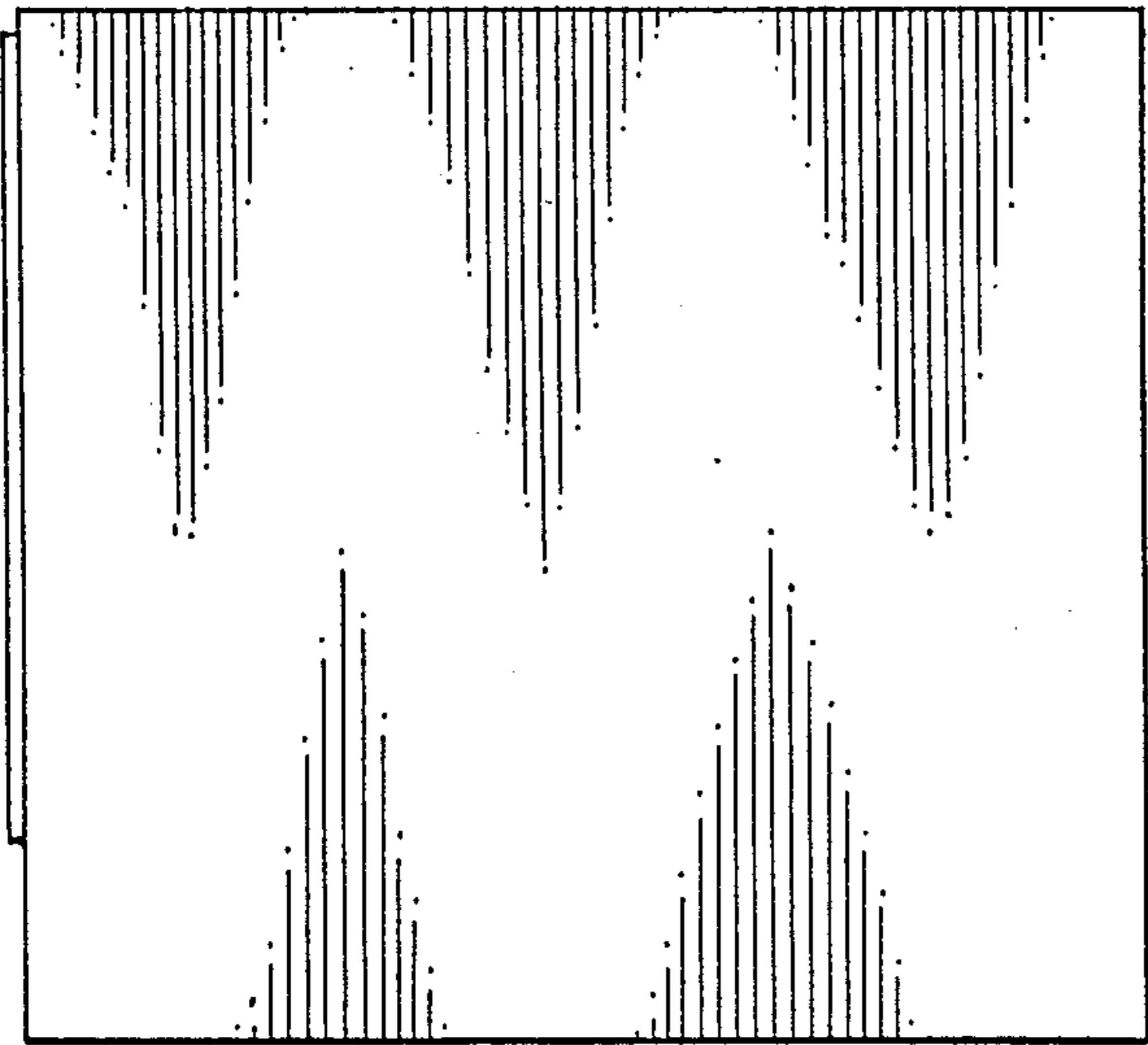

FIG.
17.



FIG. 18.



FIG. 19.

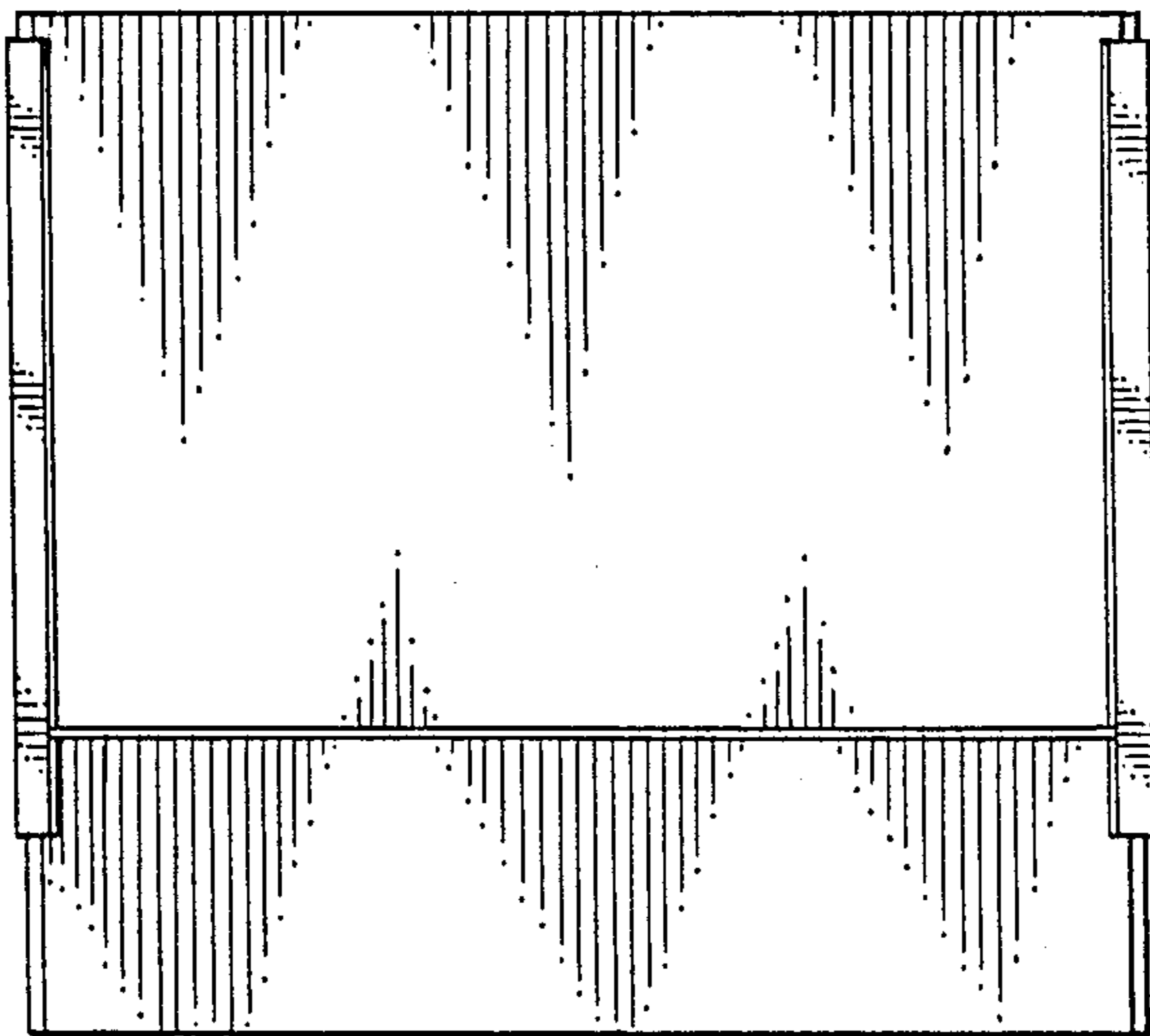

FIG. 20.



FIG. 21.

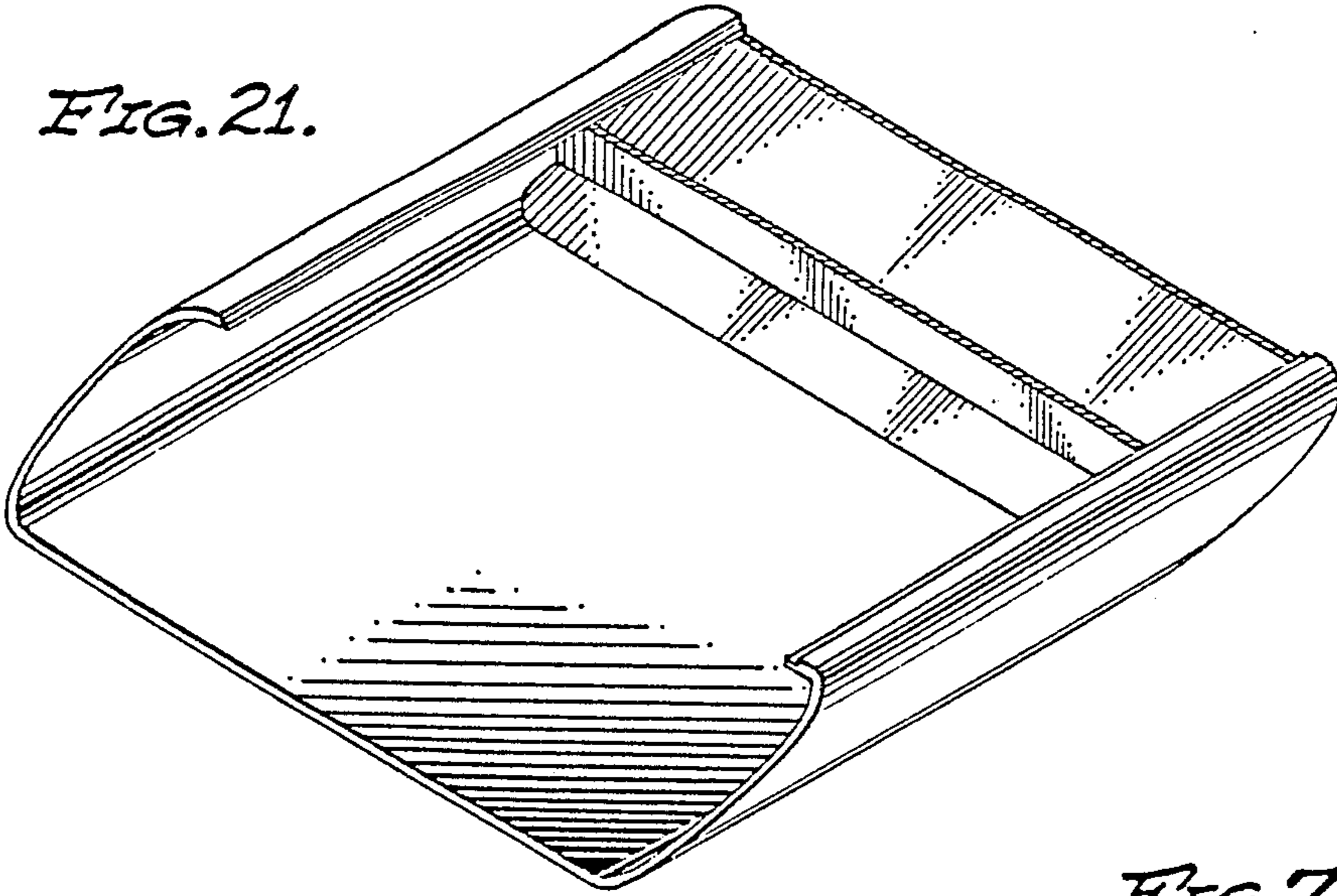

FIG. 7.

