

[54] CHAIR FRAME OR SIMILAR ARTICLE

4,066,293 6/1976 Meier 297/325

[75] Inventor: Marks M. Conn, Moorpark, Calif.

Primary Examiner—Bruce W. Dunkins
Attorney, Agent, or Firm—Spensley Horn Jubas & Lubitz

[73] Assignee: Mallin Company, Los Angeles, Calif.

[**] Term: 14 Years

[57] CLAIM

[21] Appl. No.: 805,137

The ornamental design for a chair frame or similar article, as shown.

[22] Filed: Nov. 14, 1985

[52] U.S. Cl. D6/373

[58] Field of Search D6/334, 348, 360, 361, D6/367, 368, 369; 297/21, 271, 325, 441

DESCRIPTION

[56] References Cited

U.S. PATENT DOCUMENTS

- D. 271,728 12/1983 Burns D6/348
- D. 280,276 8/1985 McKay D6/361 X
- D. 281,560 12/1985 Murry D6/361 X
- D. 291,750 9/1987 Baroody et al. D6/369

FIG. 1 is a perspective view illustrating a chair frame or similar article of my design.

FIG. 2 is a front elevation view thereof;

FIG. 3 is a side elevation view thereof;

FIG. 4 is a top view thereof;

FIG. 5 is a rear elevation view thereof;

FIG. 6 is a bottom view thereof;

FIG. 7 is a sectional view thereof taken along the plane 7-7 of FIG. 1 and looking in the direction of the arrows.

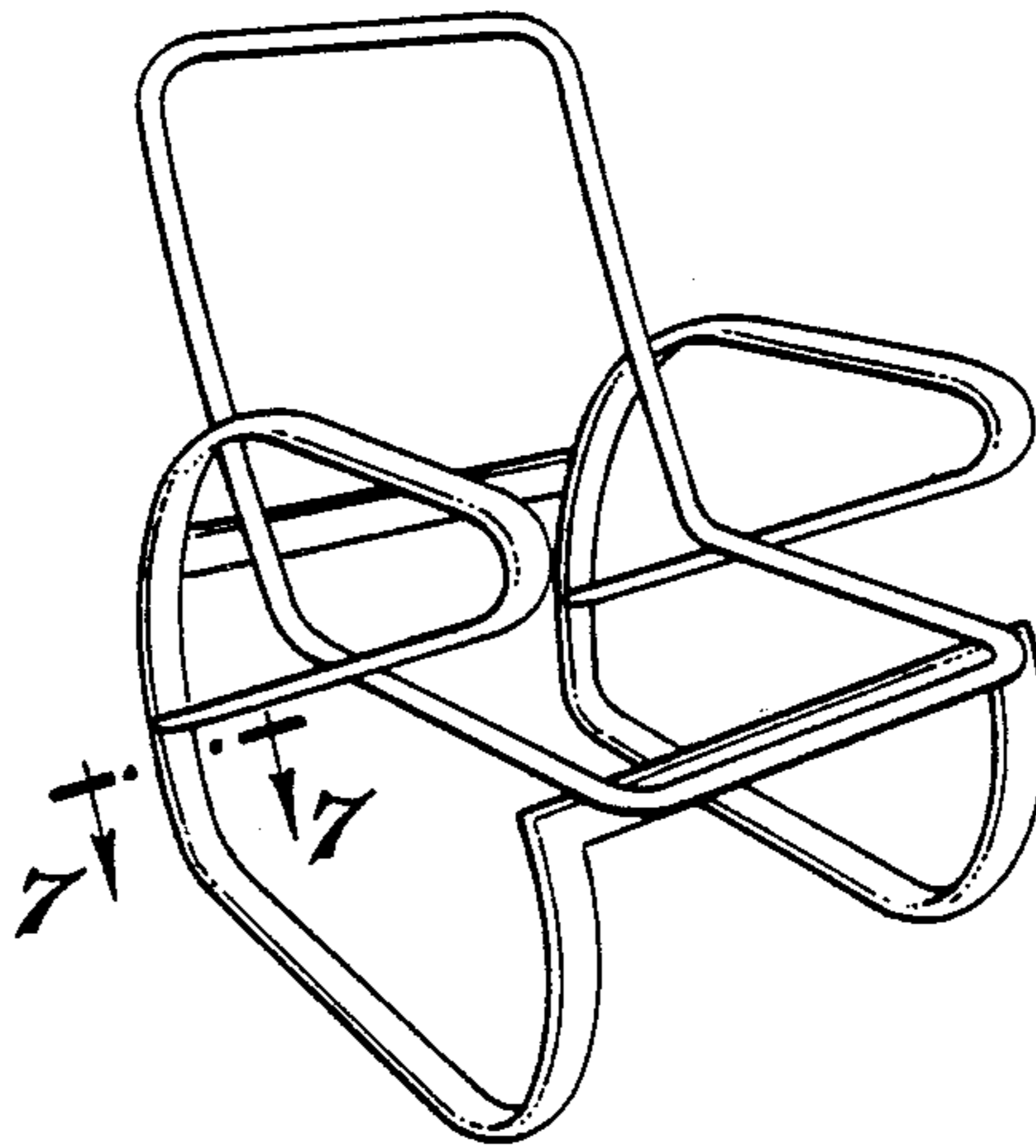

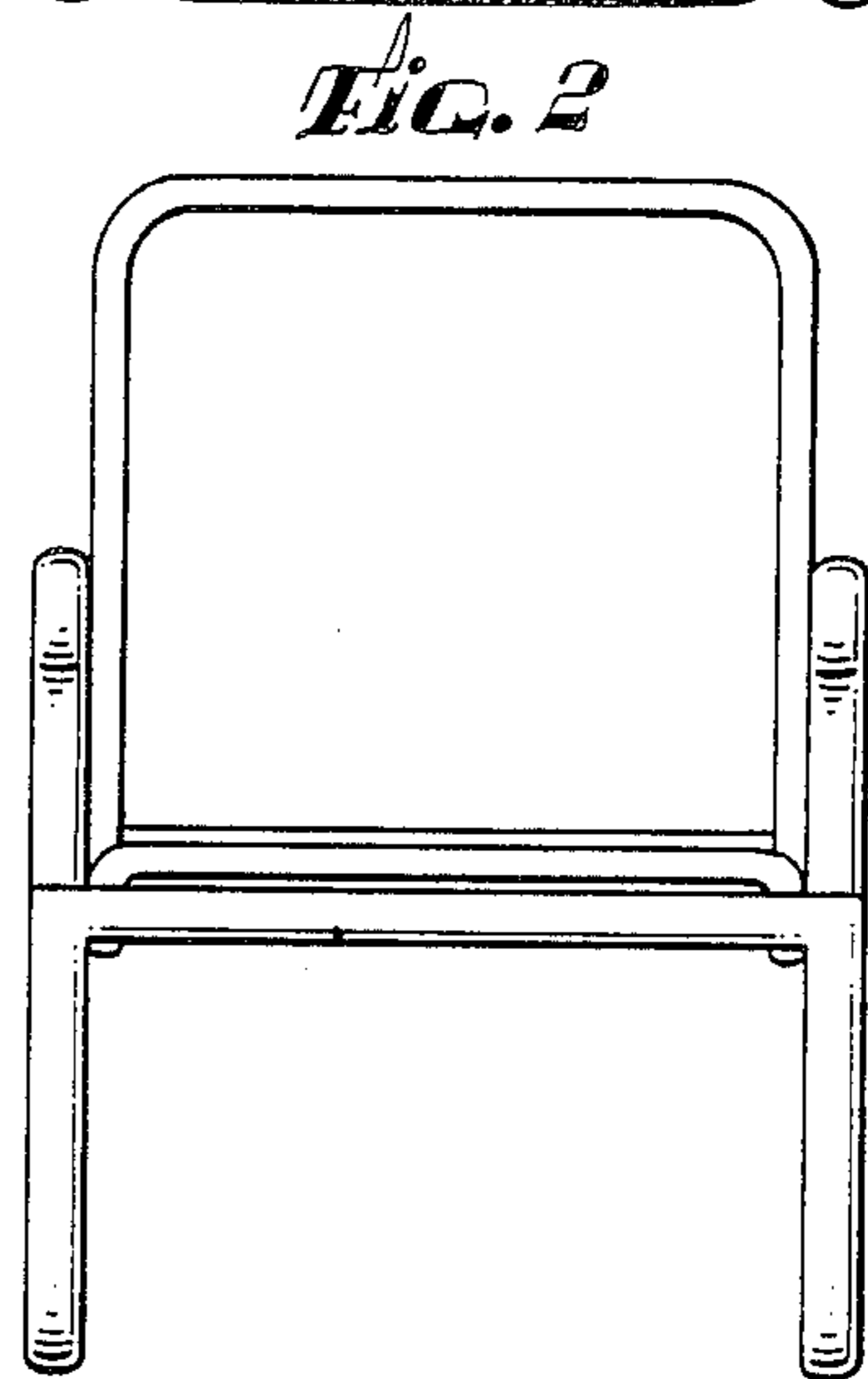
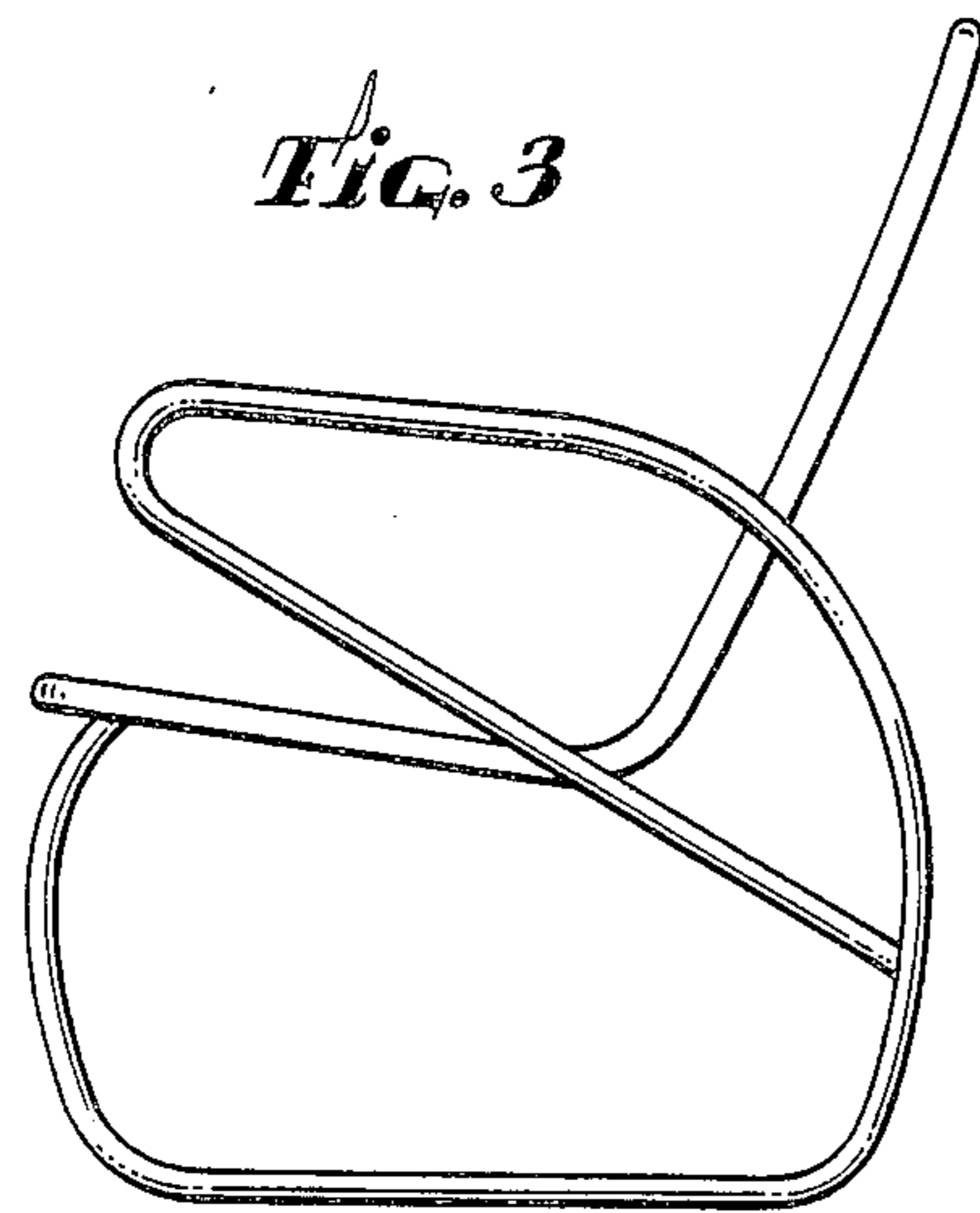
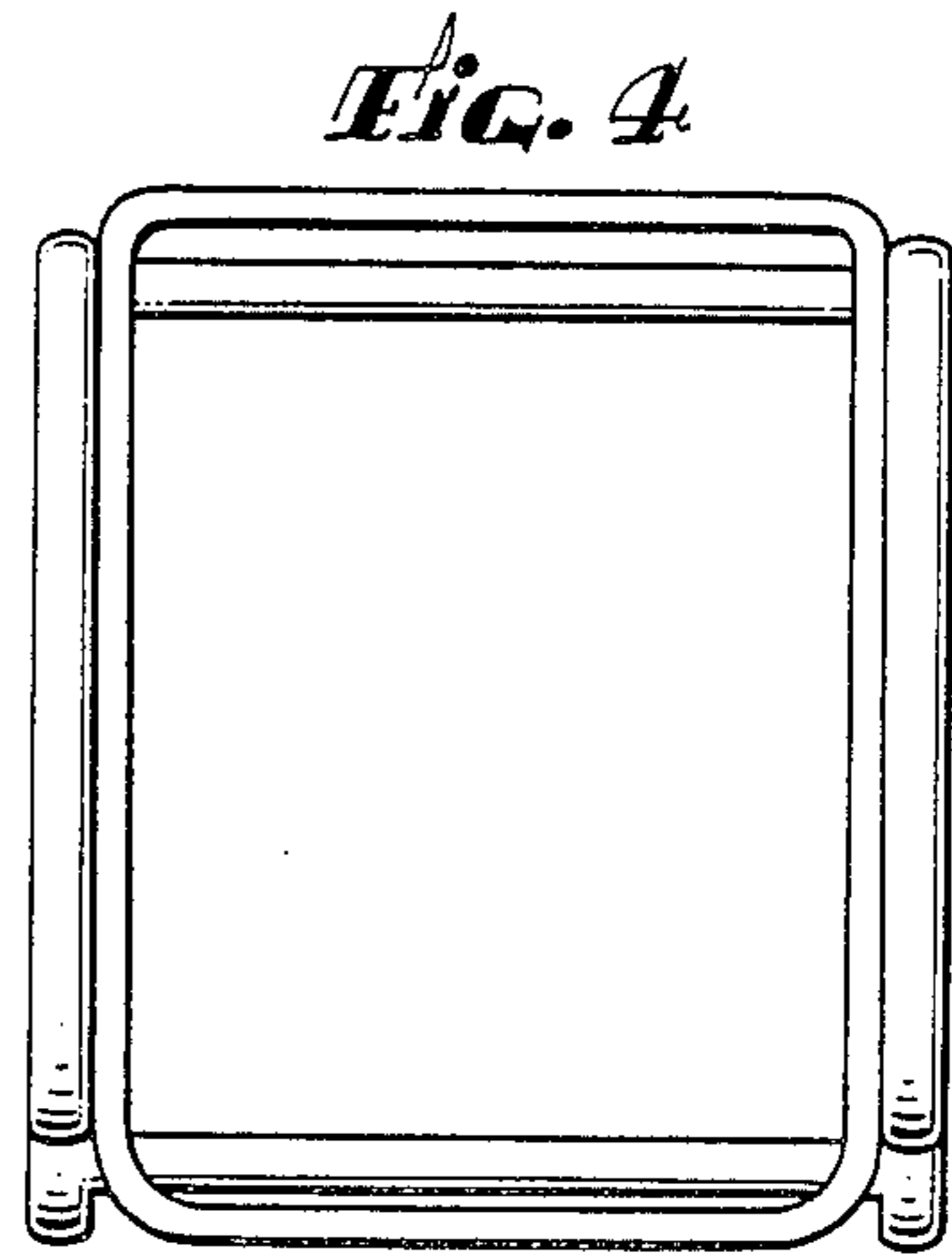
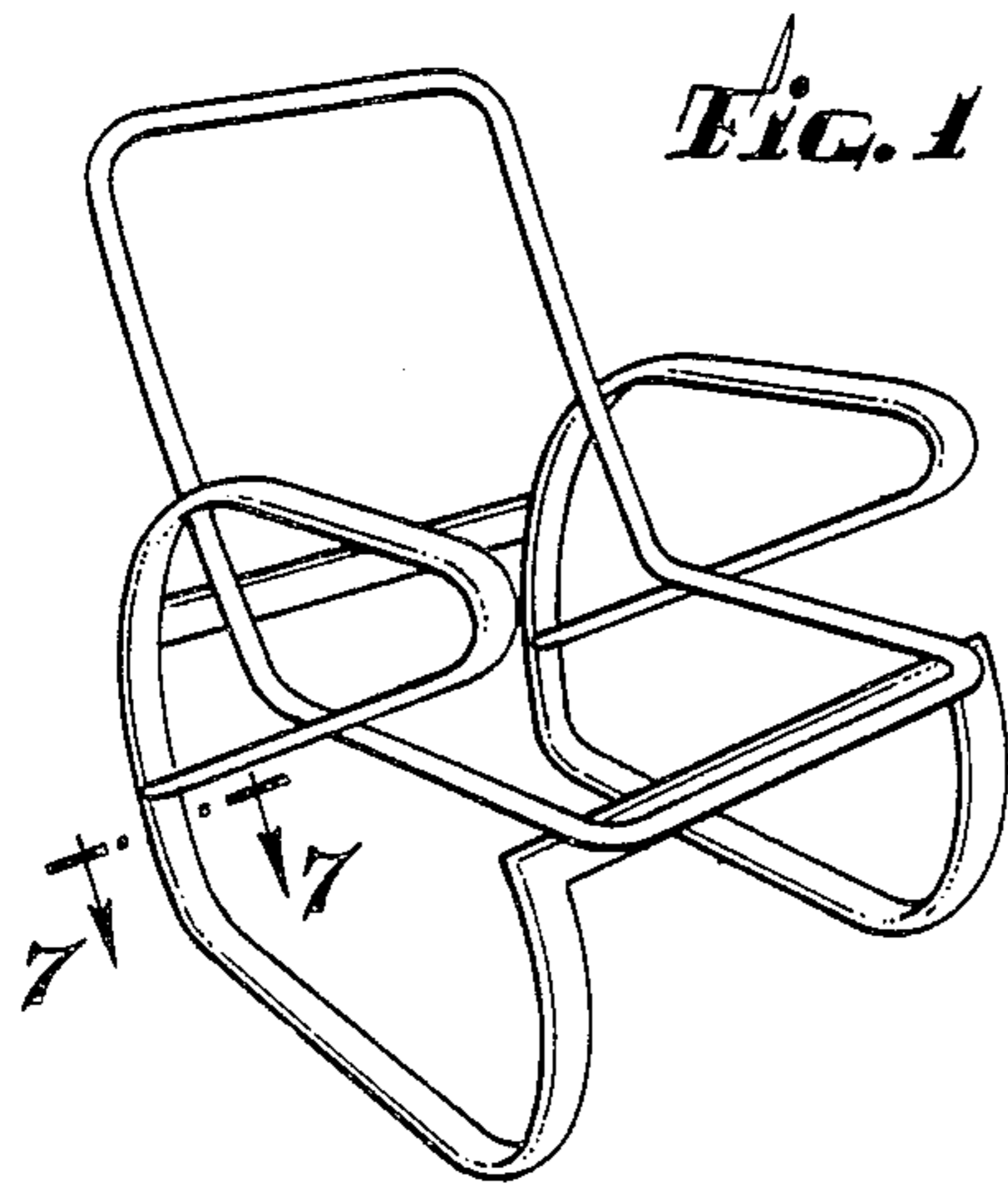

Fig. 5

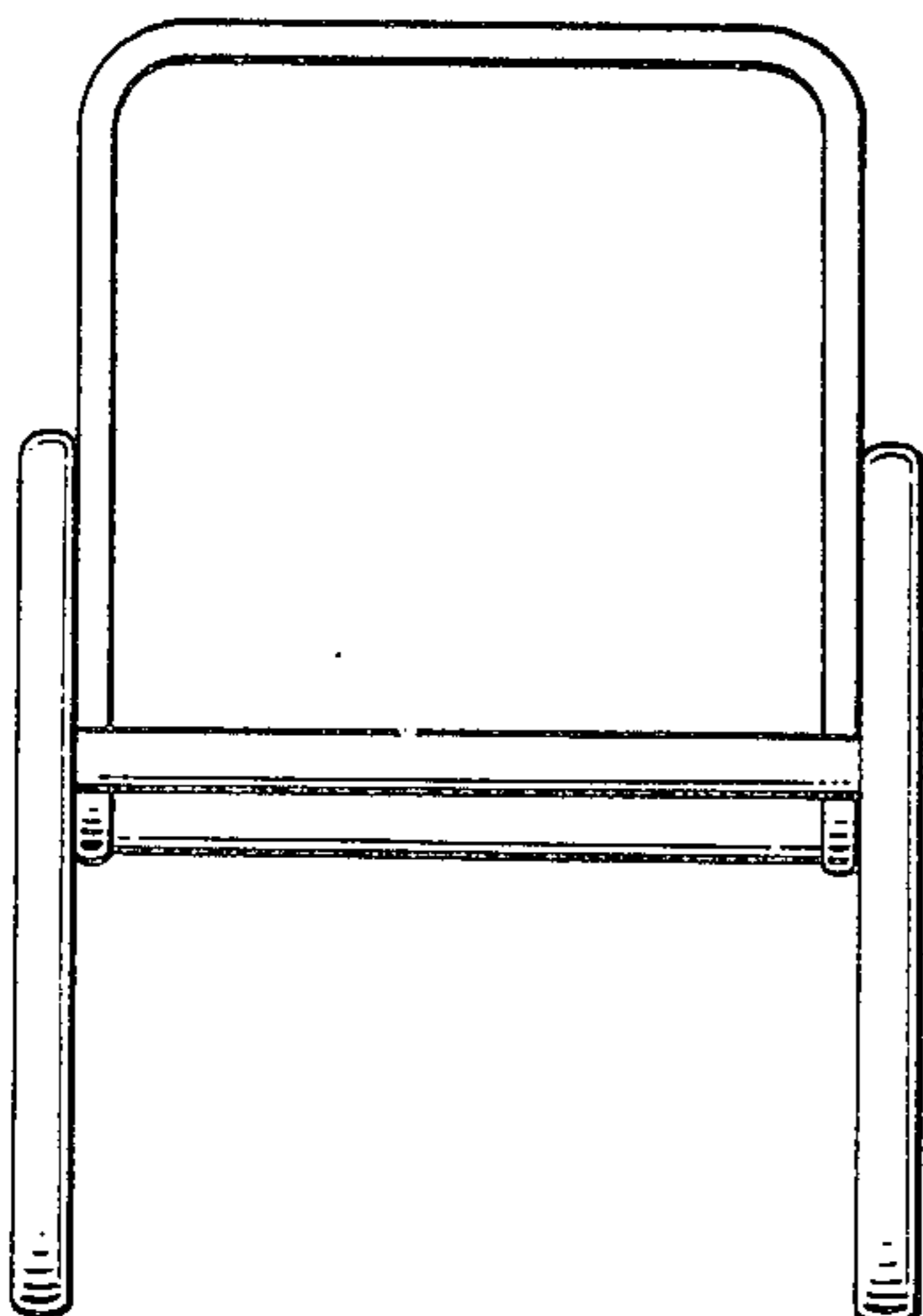

Fig. 7

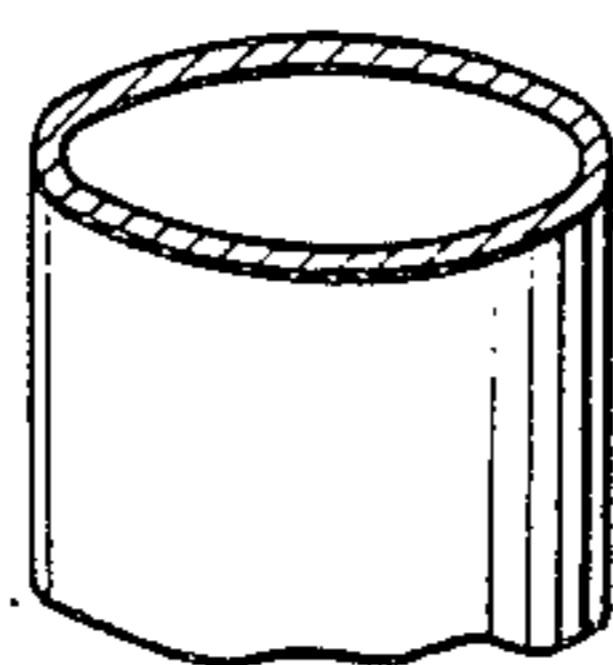

Fig. 6

