

[54] MARKING INSTRUMENT

[75] Inventors: Harry Davidson, East Weymouth; Scott G. Searle, Sudbury, both of Mass.

[73] Assignee: The Gillette Company, Boston, Mass.

[**] Term: 14 Years

[21] Appl. No.: 743,236

[22] Filed: Jun. 11, 1985

[52] U.S. Cl. D19/43

[58] Field of Search D19/41-51, D19/35, 36, 54-57; 401/201, 202, 195, 262, 34

[56] References Cited

U.S. PATENT DOCUMENTS

D. 107,438	12/1937	McNally	19/36
D. 115,916	3/1939	Donato	19/36
D. 158,051	4/1950	Compas	19/43
D. 160,757	10/1950	Weiss	19/36
D. 248,865	8/1978	Sussman et al.	D19/43
D. 260,272	8/1981	Horntrich	19/43
D. 268,501	4/1983	Kruckel et al.	19/43
D. 268,935	5/1983	Horntrich	19/43
D. 268,935	5/1983	Horntrich	D19/43
D. 271,889	12/1983	Kruckel	19/43

D. 282,378	1/1986	Ohyabu et al.
3,161,904	12/1964	Goldrich
3,684,389	8/1972	Eron
3,917,416	11/1975	Steyer
4,183,685	1/1980	Hofmann et al.
4,509,875	4/1985	Shintani

Primary Examiner—Charles A. Rademaker
Attorney, Agent, or Firm—John P. Morley

[57] CLAIM

The ornamental design for a marking instrument shown and described.

DESCRIPTION

FIG. 1 is an exploded perspective view of a marking instrument showing our new design; FIG. 2 is a front elevational view of the instrument with the caps affixed on both ends; FIG. 3 is a rear elevational view thereof; FIG. 4 is a right side elevational view thereof; FIG. 5 is a left side elevational view thereof; FIG. 6 is a top plan view thereof; FIG. 7 is a bottom plan view thereof; FIG. 8 is a perspective view thereof with the cap removed from one end of the instrument; and FIG. 9 is a perspective view thereof with the cap removed from the other end of the instrument.

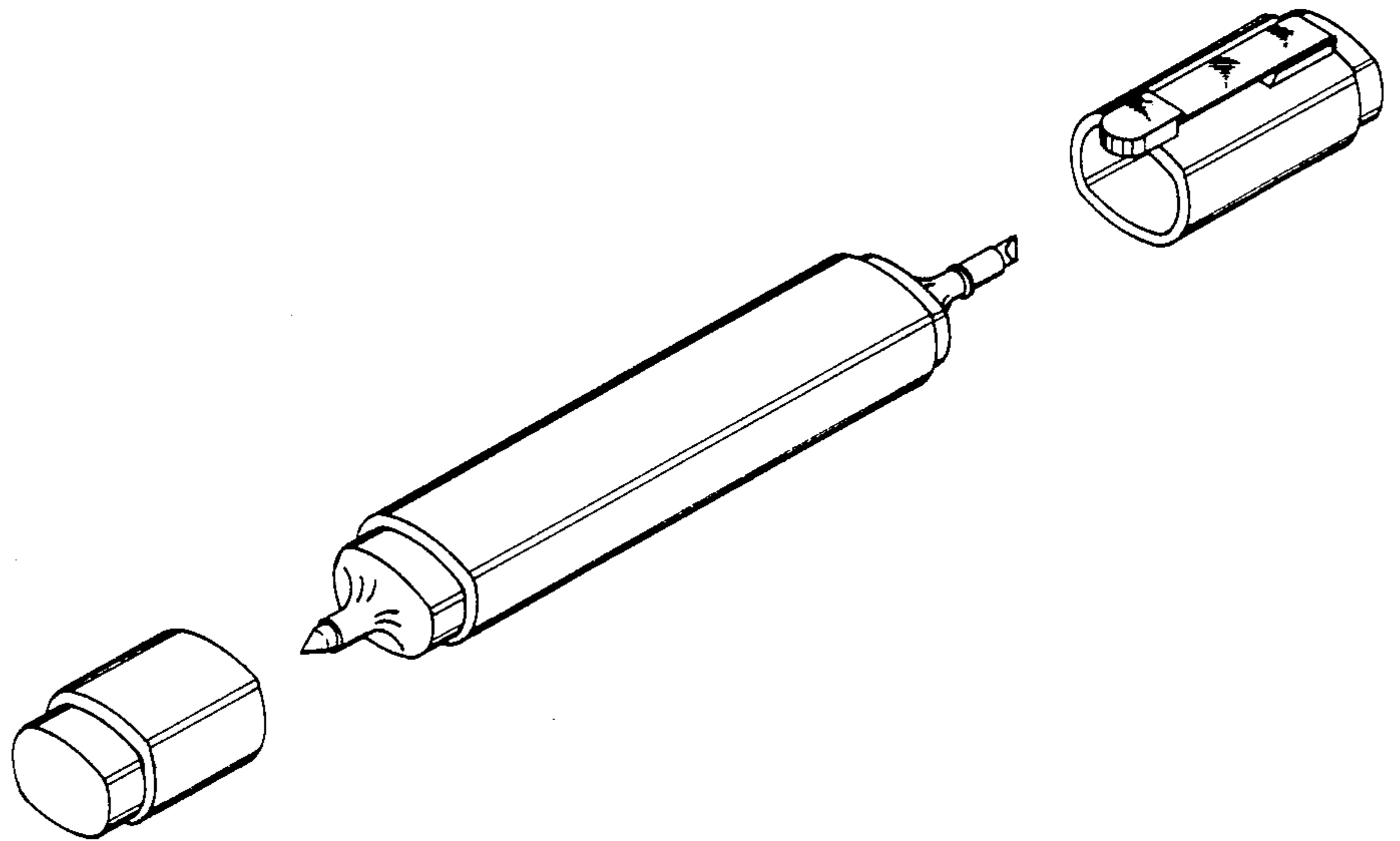

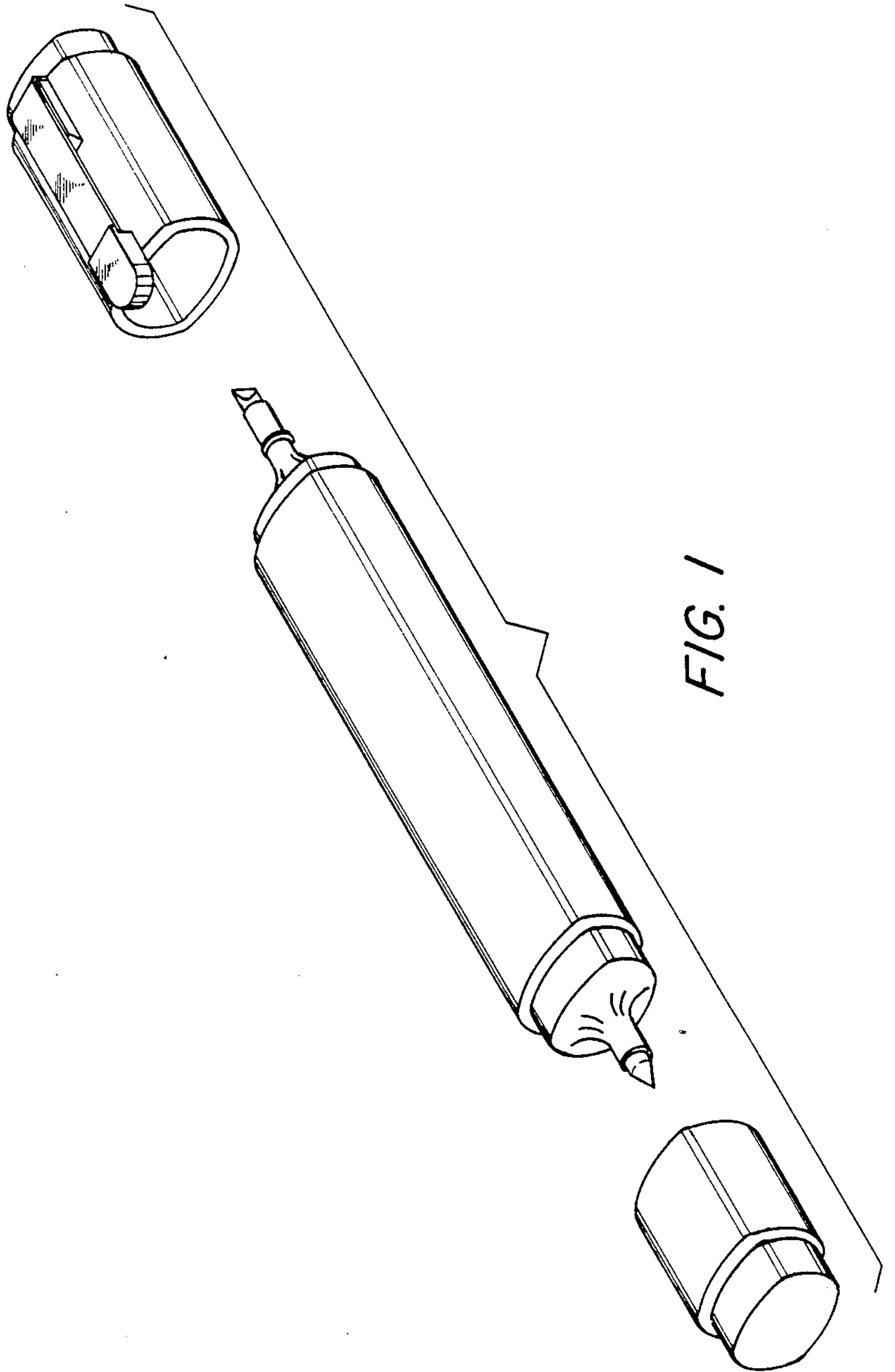

FIG. 1

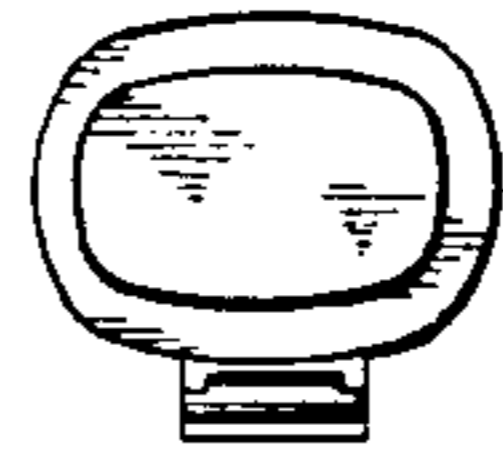

FIG. 6

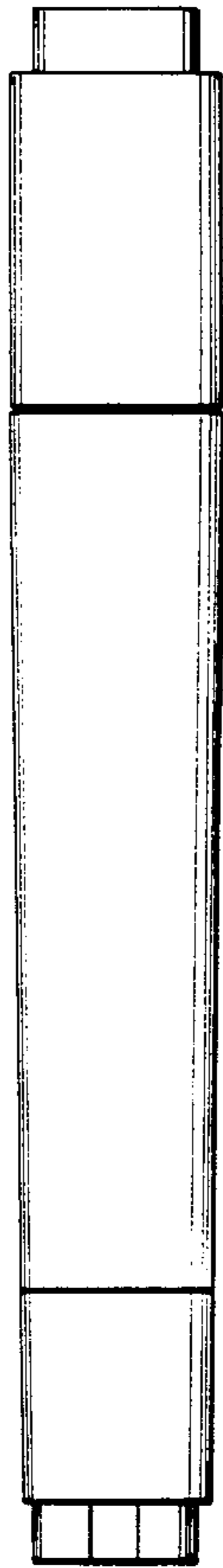

FIG. 3

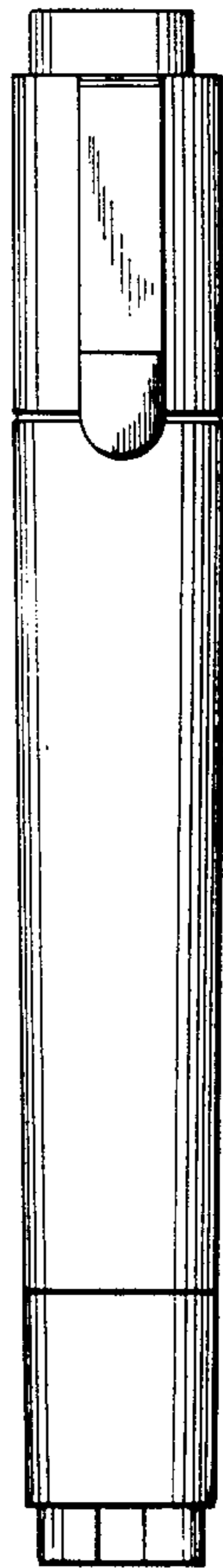

FIG. 2

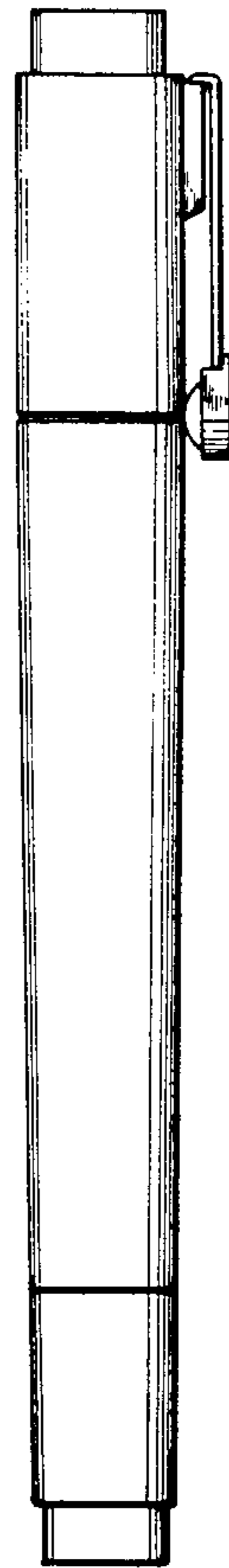

FIG. 4

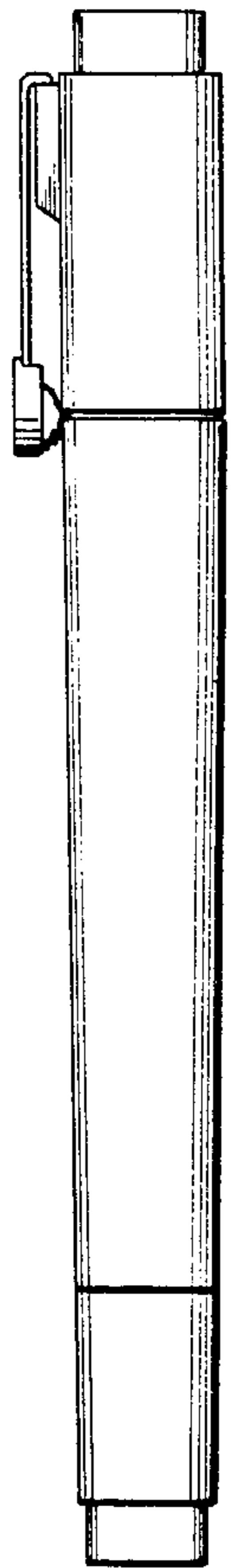

FIG. 5



FIG. 7

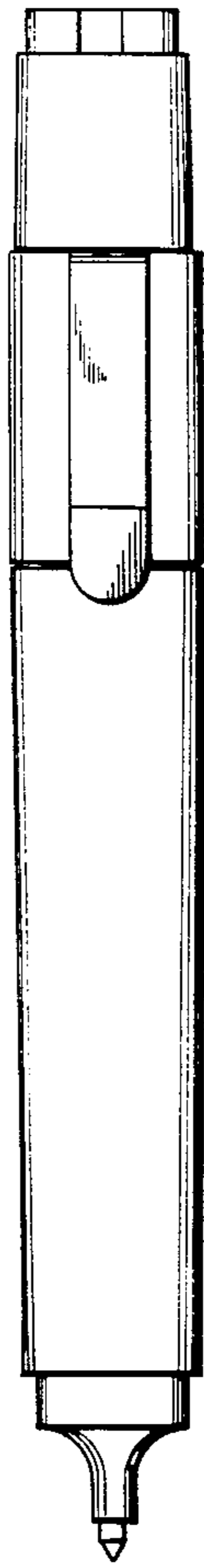

FIG. 8

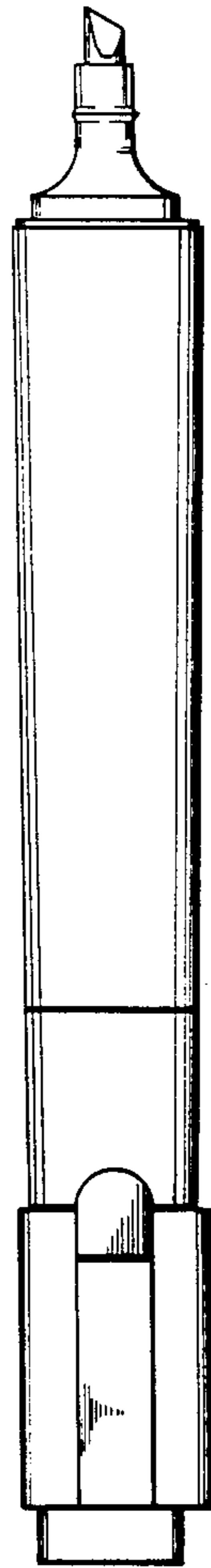

FIG. 9