

# United States Patent [19]

Yamamoto et al.

[11] Patent Number: **Des. 295,504**

[45] Date of Patent: **\*\* May 3, 1988**

[54] **TAPE MEASURE WITH DIGITAL DISPLAY**

[75] Inventors: **Nobuyuki Yamamoto; Tatsuaki Nakai**, both of Kyoto, Japan

[73] Assignee: **Kyoto Measuring Instruments Corporation**, Kyoto, Japan

[\*\*] Term: **14 Years**

[21] Appl. No.: **774,812**

[22] Filed: **Sep. 11, 1985**

[52] U.S. Cl. .... **D10/72**

[58] Field of Search ..... **D10/70-72;**  
**33/137 R, 138 R, 139, 140**

[56] **References Cited**

**U.S. PATENT DOCUMENTS**

D. 154,059	6/1949	Olson	.....	D10/72
D. 216,534	2/1970	Zelnick	.....	D10/72
D. 277,834	3/1985	Reeves	.....	D10/72

4,551,847	11/1985	Caldwell	.....	33/137 R X
4,611,402	9/1986	Yamamoto	.....	33/139
4,658,134	4/1987	Okumura	.....	33/140 X

*Primary Examiner*—Nelson C. Holtje  
*Attorney, Agent, or Firm*—Brumbaugh, Graves,  
Donohue & Raymond

[57] **CLAIM**

The ornamental design for a tape measure with digital display, substantially as shown.

**DESCRIPTION**

FIG. 1 is a right side elevational view of a tape measure with digital display, showing our new design;  
FIG. 2 is a left side elevational view thereof;  
FIG. 3 is a rear elevational view thereof;  
FIG. 4 is a front elevational view thereof;  
FIG. 5 is a top plan view thereof;  
FIG. 6 is a bottom plan view thereof;  
FIG. 7 is a top and right front perspective view thereof.

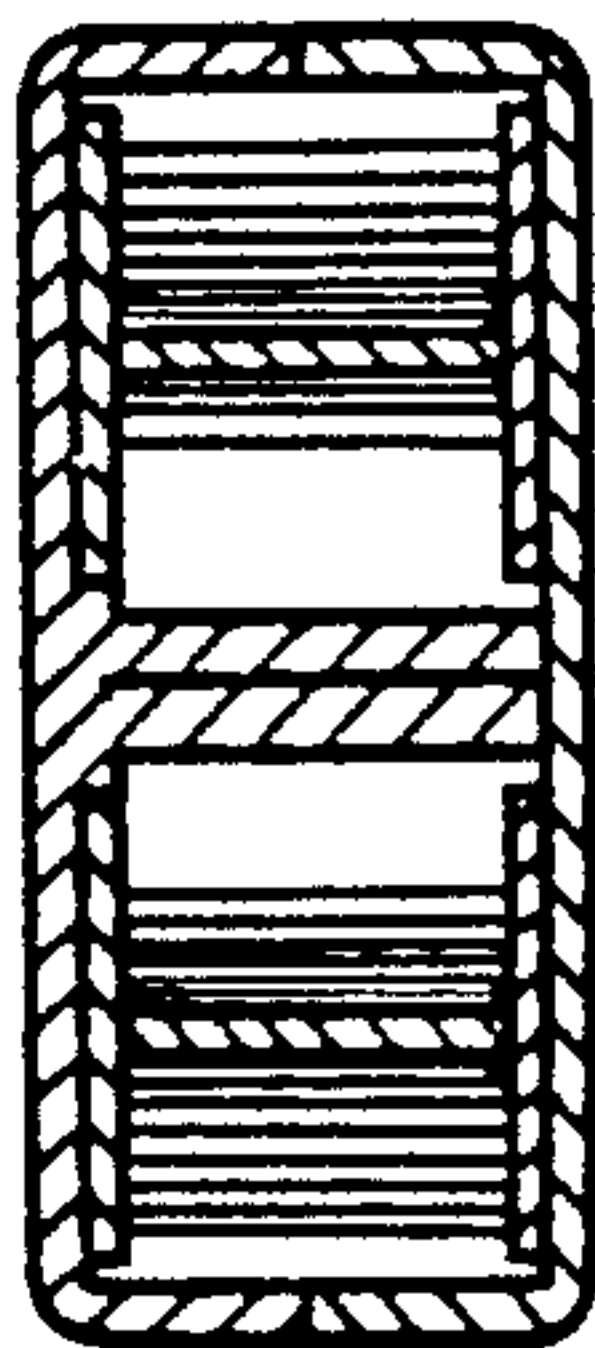

FIG. 1

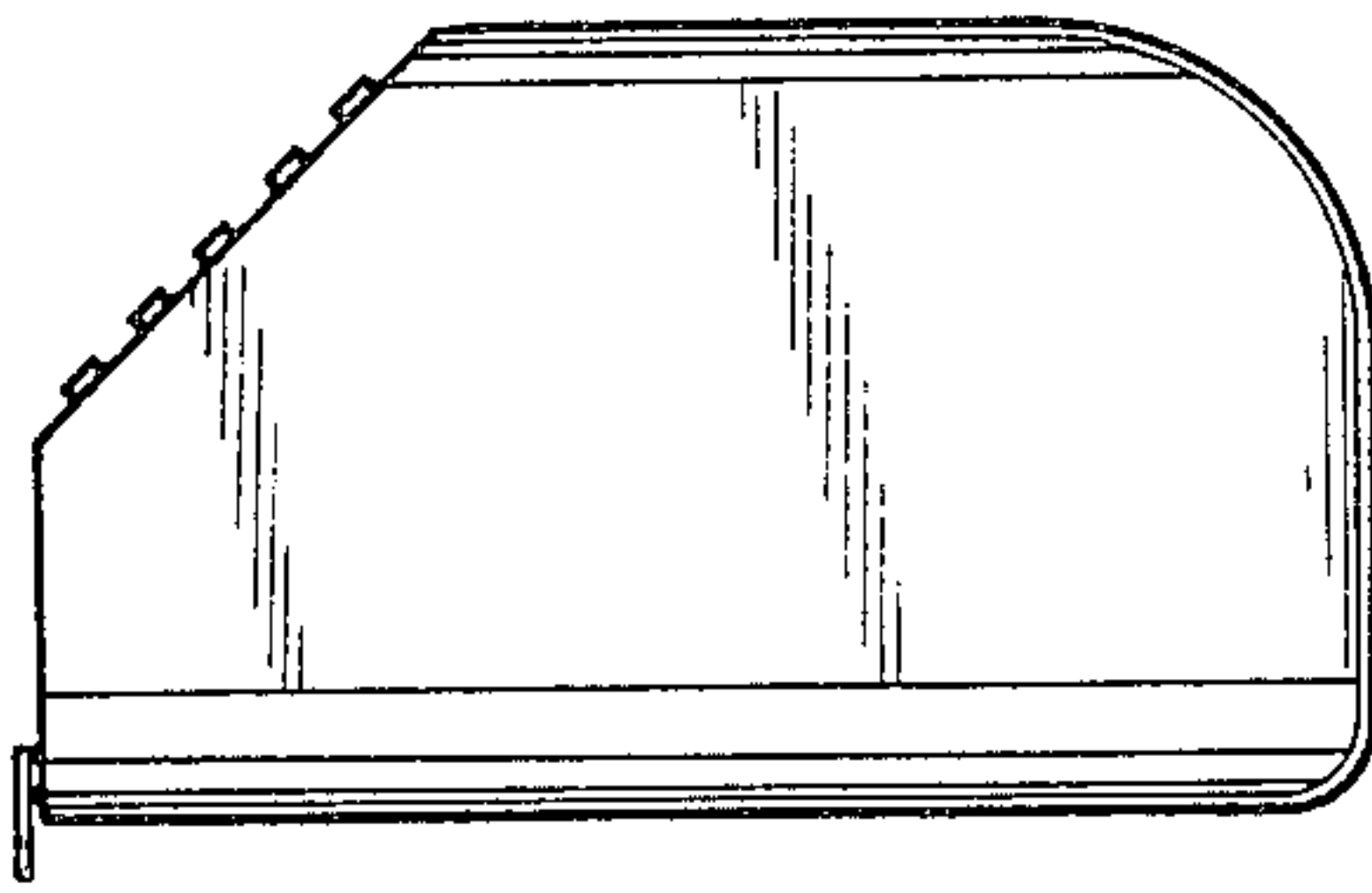

FIG. 7

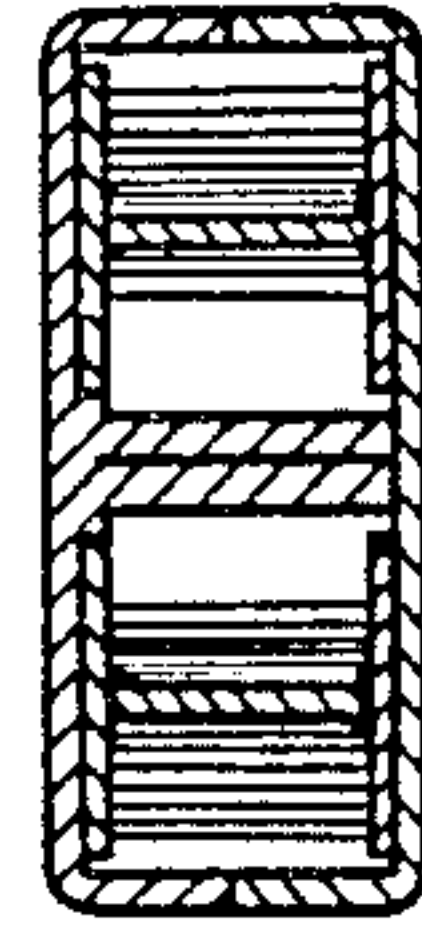

FIG. 3

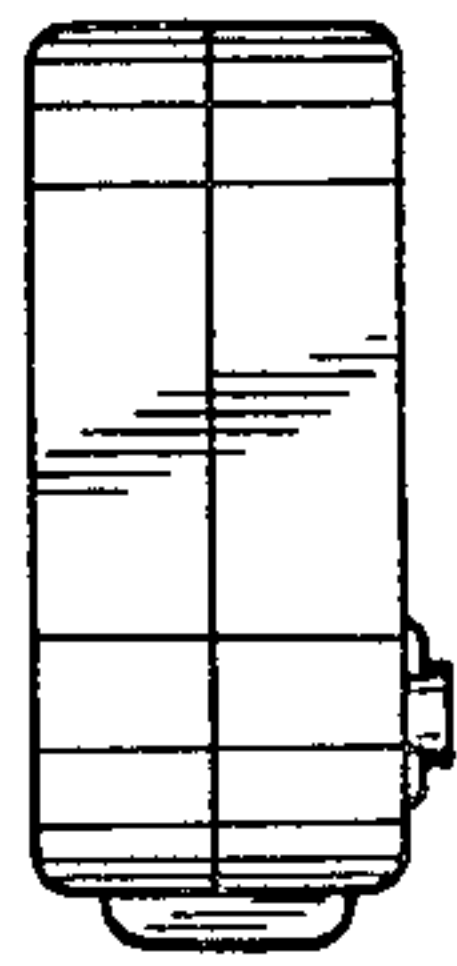

FIG. 2

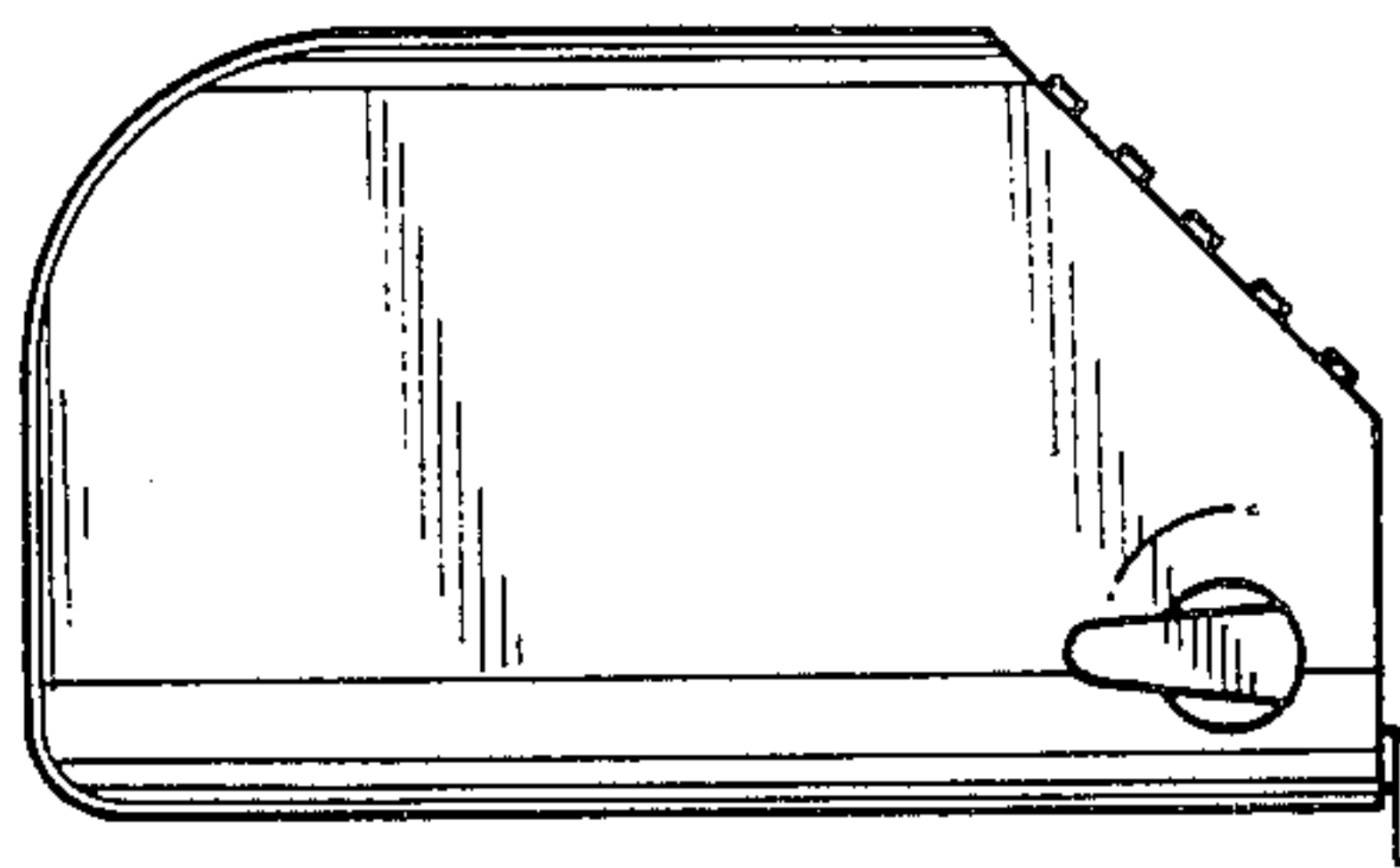

FIG. 4

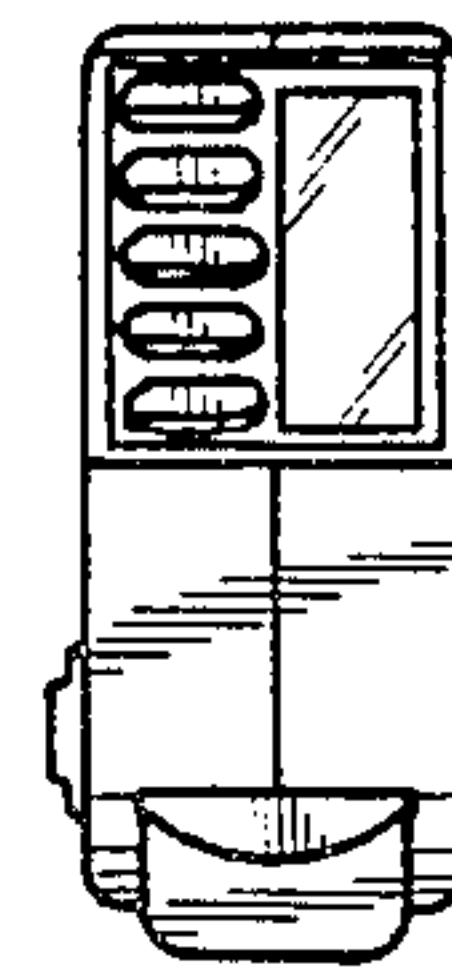

FIG. 5

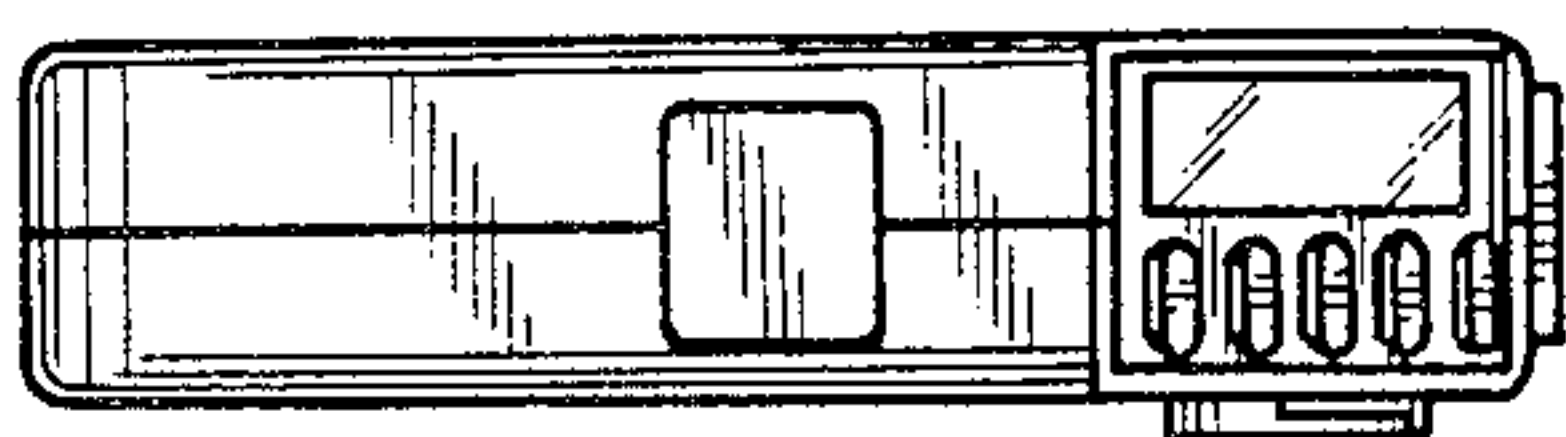

FIG. 6

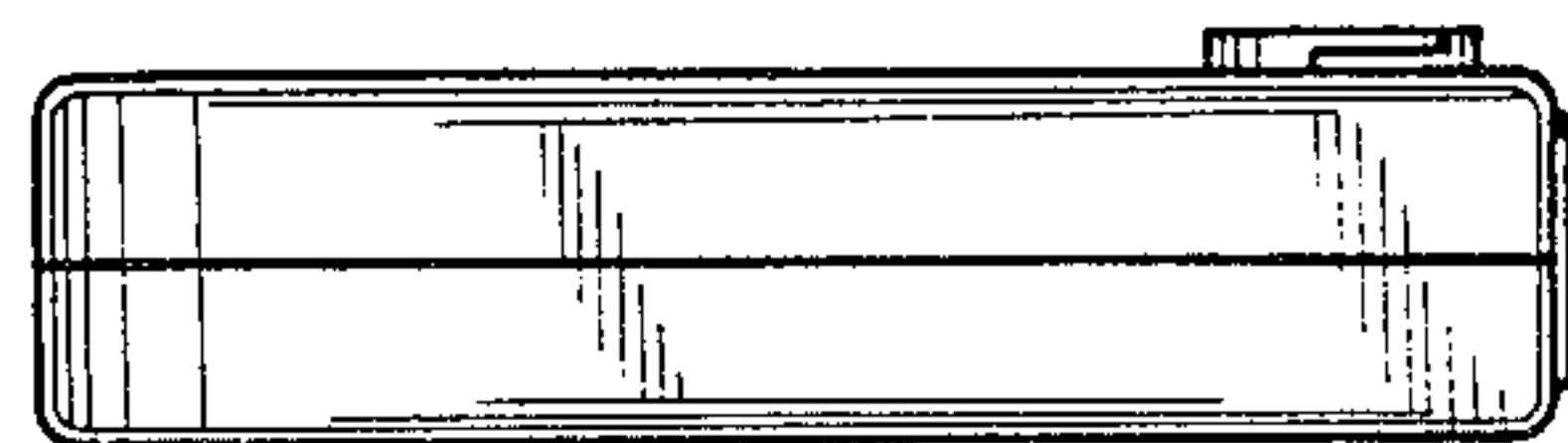

FIG. 8

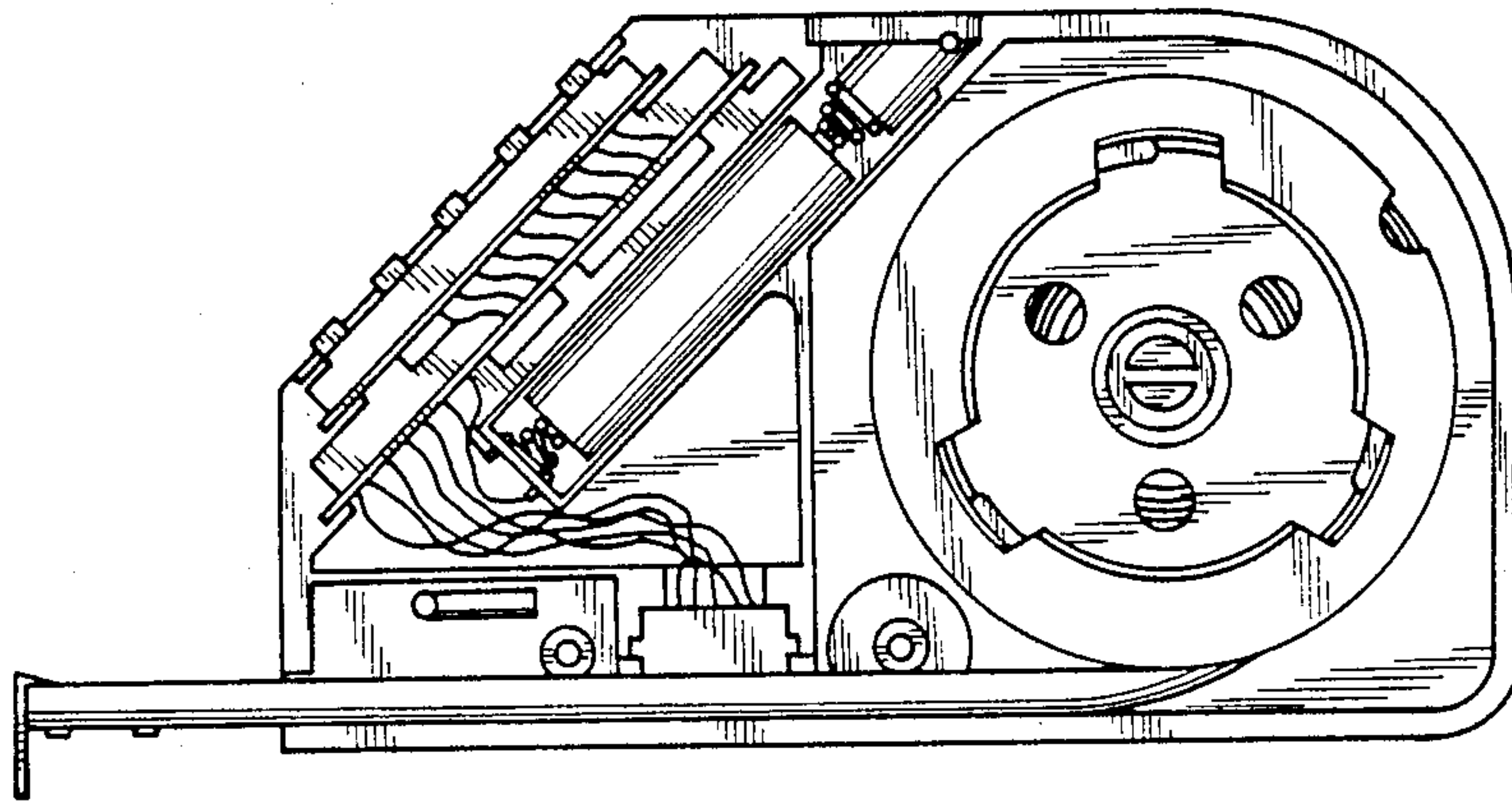
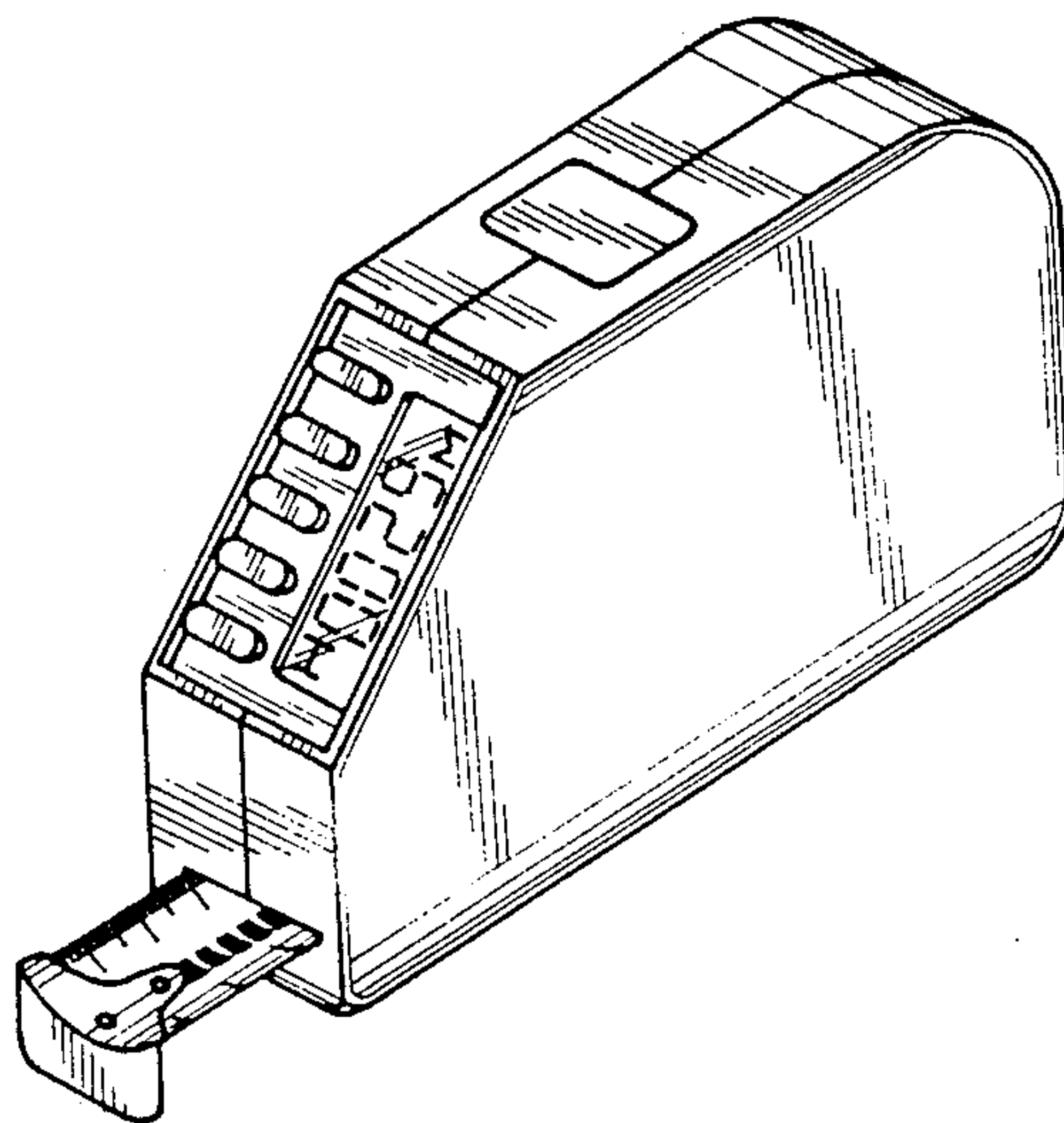

FIG. 9



UNITED STATES PATENT AND TRADEMARK OFFICE  
**CERTIFICATE OF CORRECTION**

PATENT NO. : D295,504  
DATED : May 3, 1988  
INVENTOR(S) : Yamamoto et al.

It is certified that error appears in the above-identified patent and that said Letters Patent is hereby corrected as shown below:

Delete "Fig. 7 and 8" and renumber "Fig. 9" as --Fig. 7--.

**Signed and Sealed this  
Thirteenth Day of December, 1988**

*Attest:*

*Attesting Officer*

DONALD J. QUIGG

*Commissioner of Patents and Trademarks*