

[54] COMBINATION HANDLE AND LEG FOR A FRYING PAN

[75] Inventor: Norman A. Steinkamp, La Grange Park, Ill.

[73] Assignee: Sunbeam Corporation, Downers Grove, Ill.

[\*\*] Term: 14 Years

[21] Appl. No.: 794,349

[22] Filed: Nov. 1, 1985

[52] U.S. Cl. .... D7/393; D7/360; D7/403

[58] Field of Search ..... D7/393-394, D7/354, 360, 362, 363, 365-367, 402-403; 99/403, 422, 425; 16/DIG. 19; 220/94 R, 94 A, 96

[56] References Cited

U.S. PATENT DOCUMENTS

- D. 195,688 7/1963 Fano ..... D7/393
- D. 196,131 8/1963 Becker ..... D7/403

- D. 205,150 6/1966 Cornwall, Jr. et al. .... D7/360
- D. 265,540 7/1982 Groner ..... D7/393
- D. 269,320 6/1983 Gremontprez et al. .... D7/360
- 3,209,939 5/1963 Terry et al. .... 220/94
- 3,215,063 11/1965 Olson et al. .... 220/94 R
- 3,395,266 7/1968 Price ..... 219/443
- 3,920,147 11/1975 Hiatt ..... 220/94 R

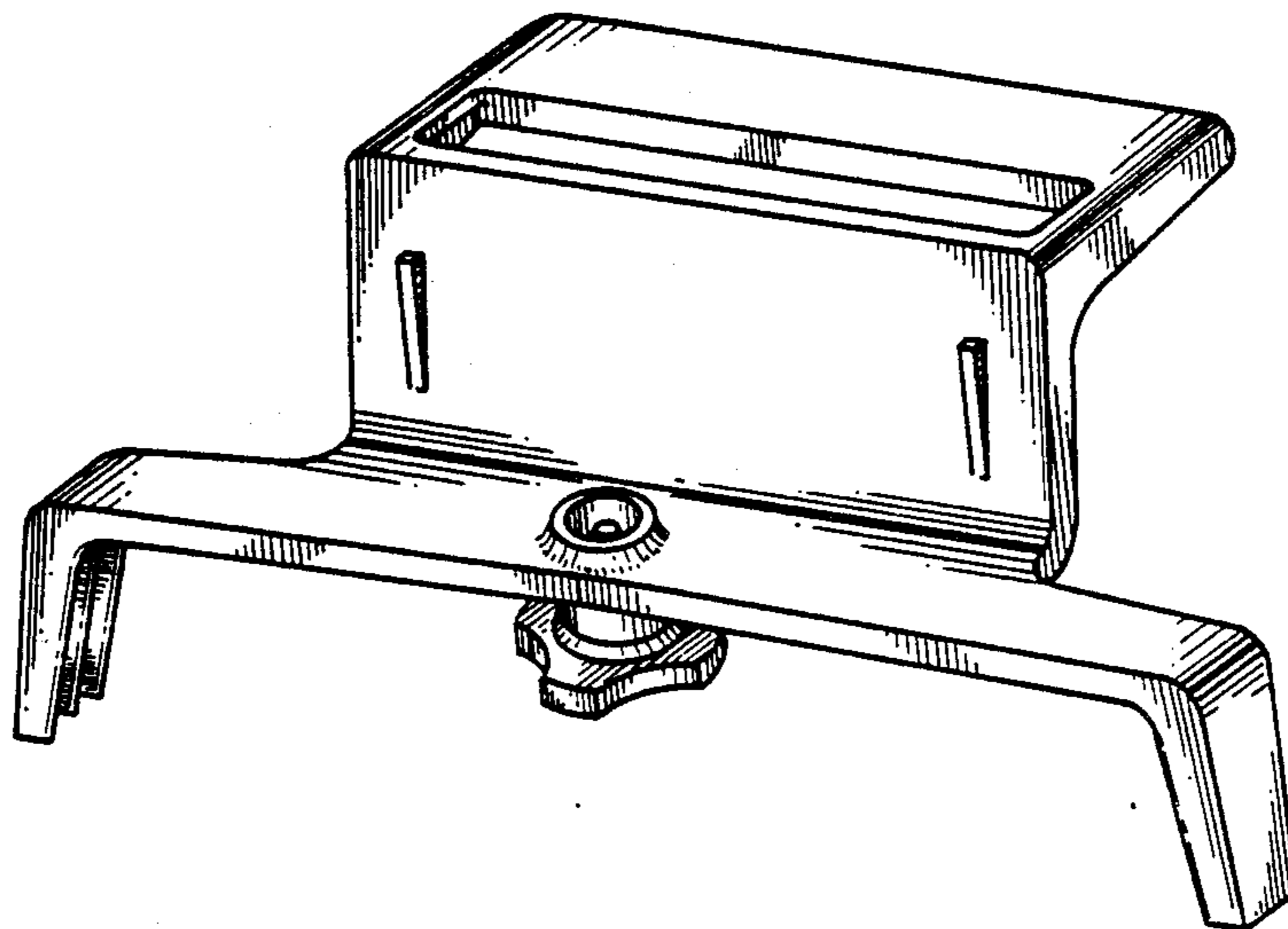
Primary Examiner—Wallace R. Burke  
Assistant Examiner—Ruth Takemoto  
Attorney, Agent, or Firm—Neil M. Rose

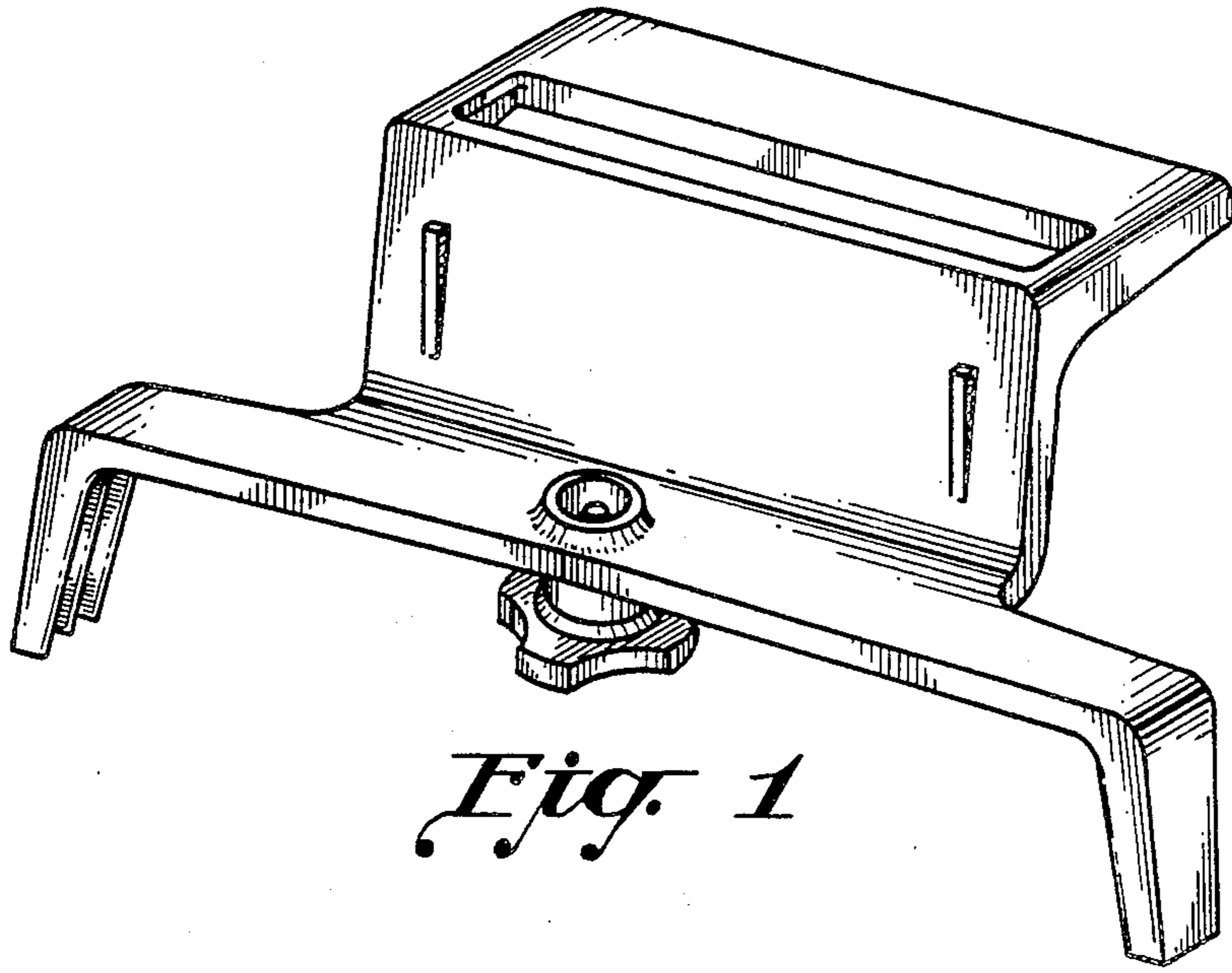
[57] CLAIM

The ornamental design for a combination handle and leg for a frying pan, as shown.

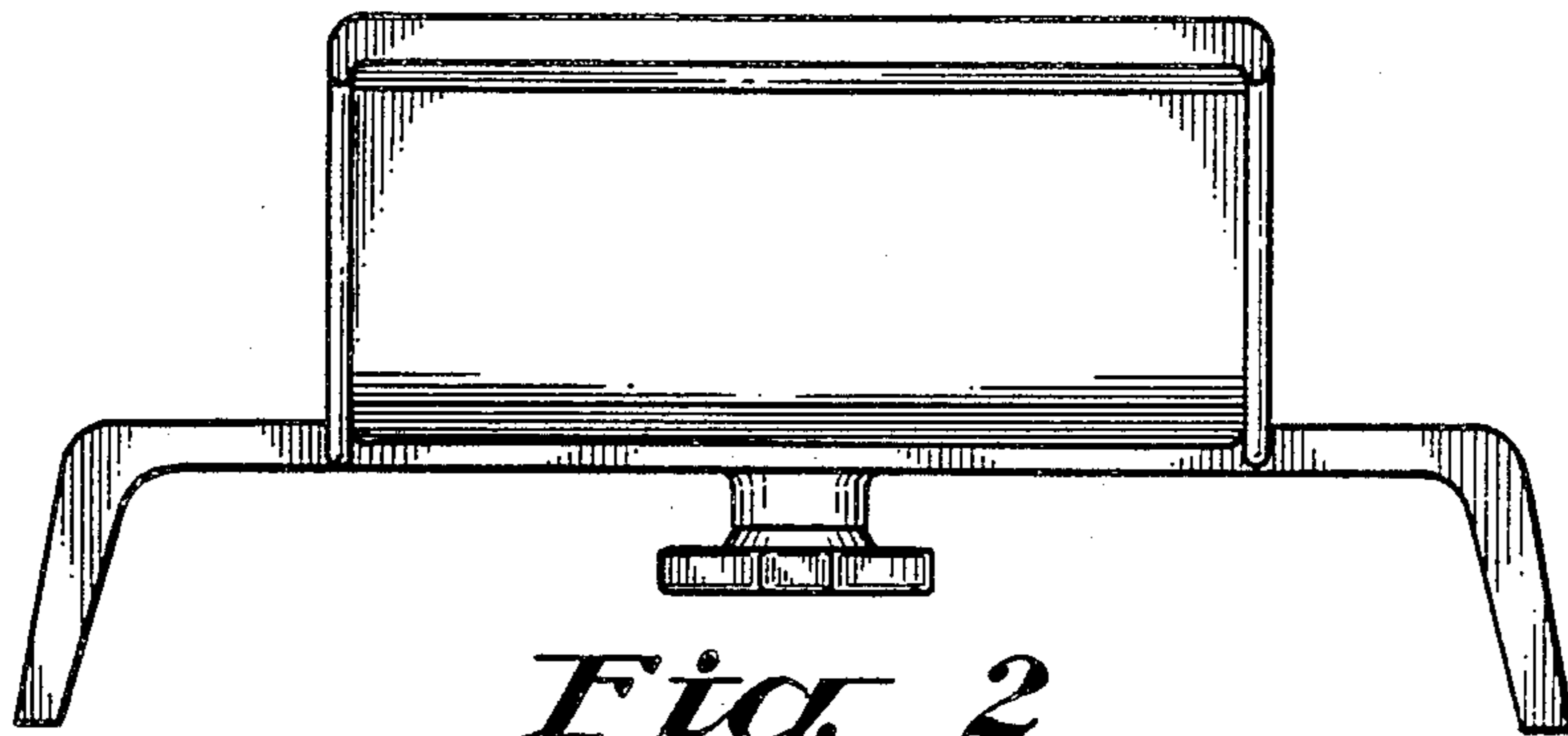
DESCRIPTION

FIG. 1 is a top, rear and left side perspective view of a combination handle and leg for a frying pan showing my new design;  
FIG. 2 is a front elevational view thereof;  
FIG. 3 is a left side elevational view thereof;  
FIG. 4 is a right side elevational view thereof;  
FIG. 5 is a top plan view thereof; and  
FIG. 6 is a bottom plan view thereof.

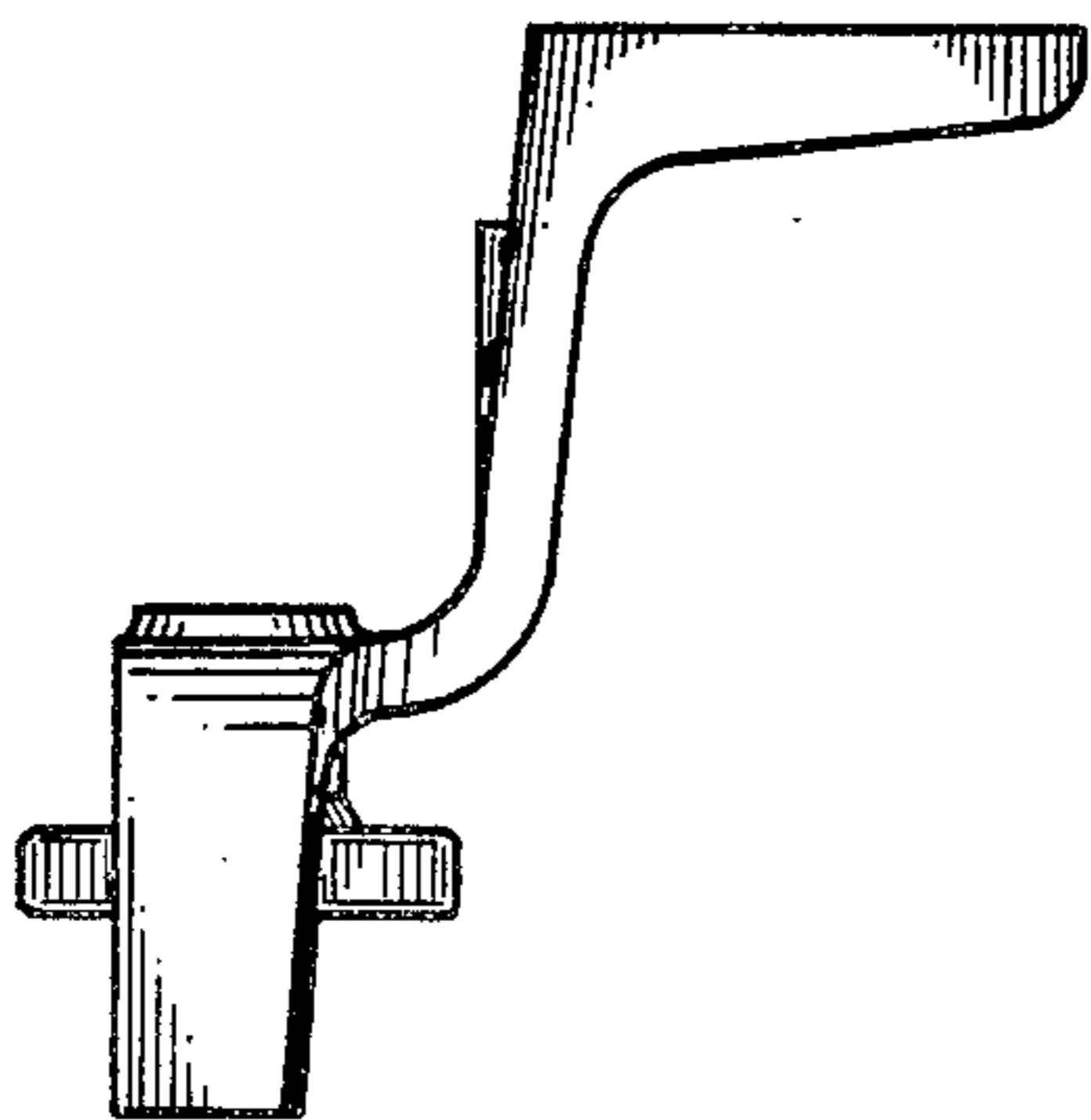




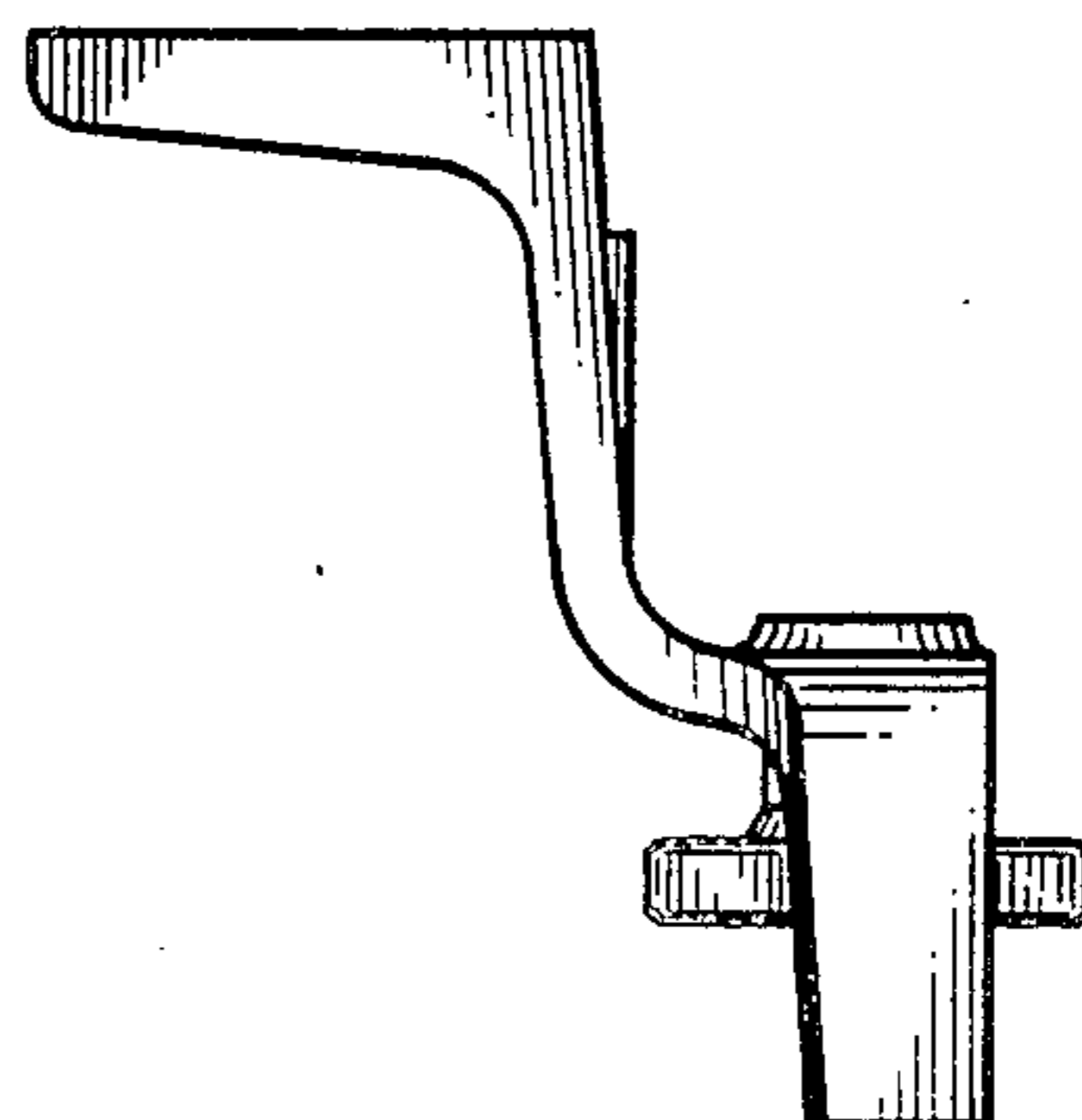
*Fig. 1*



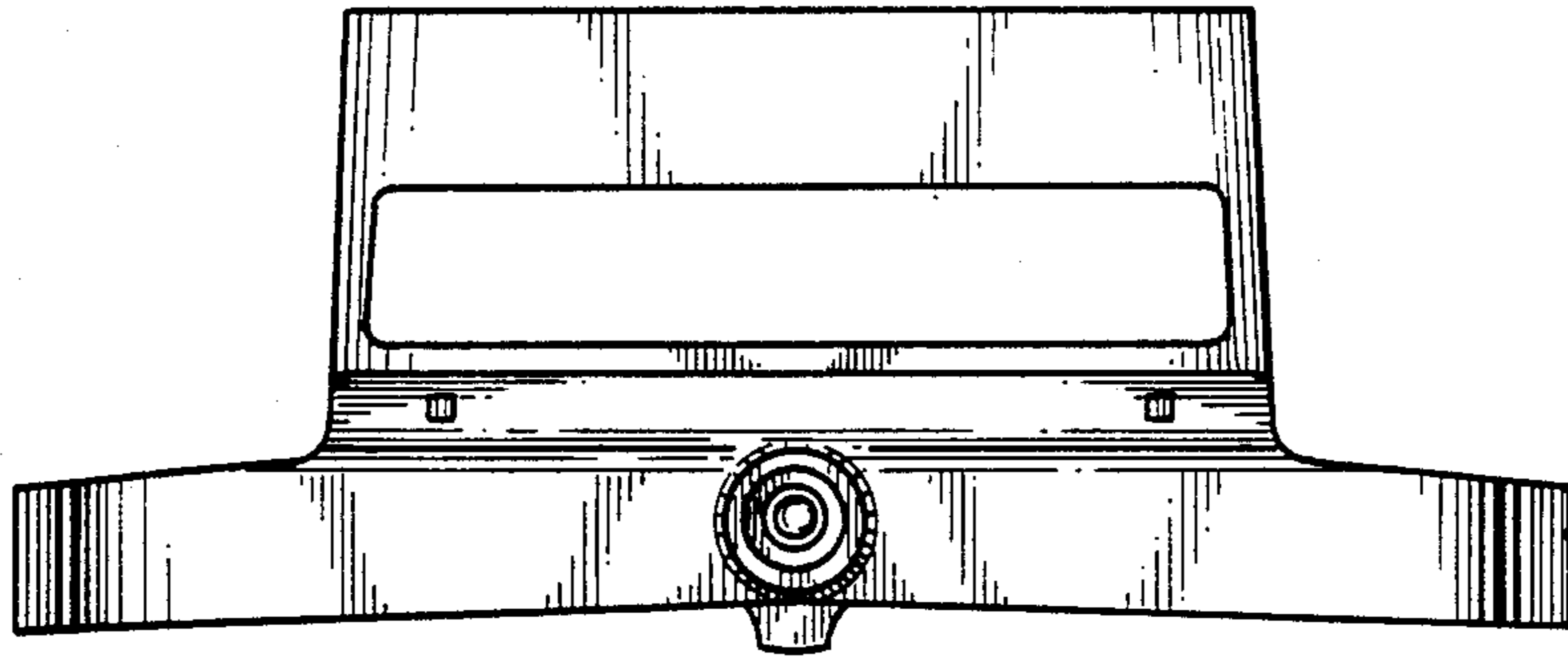
*Fig. 2*



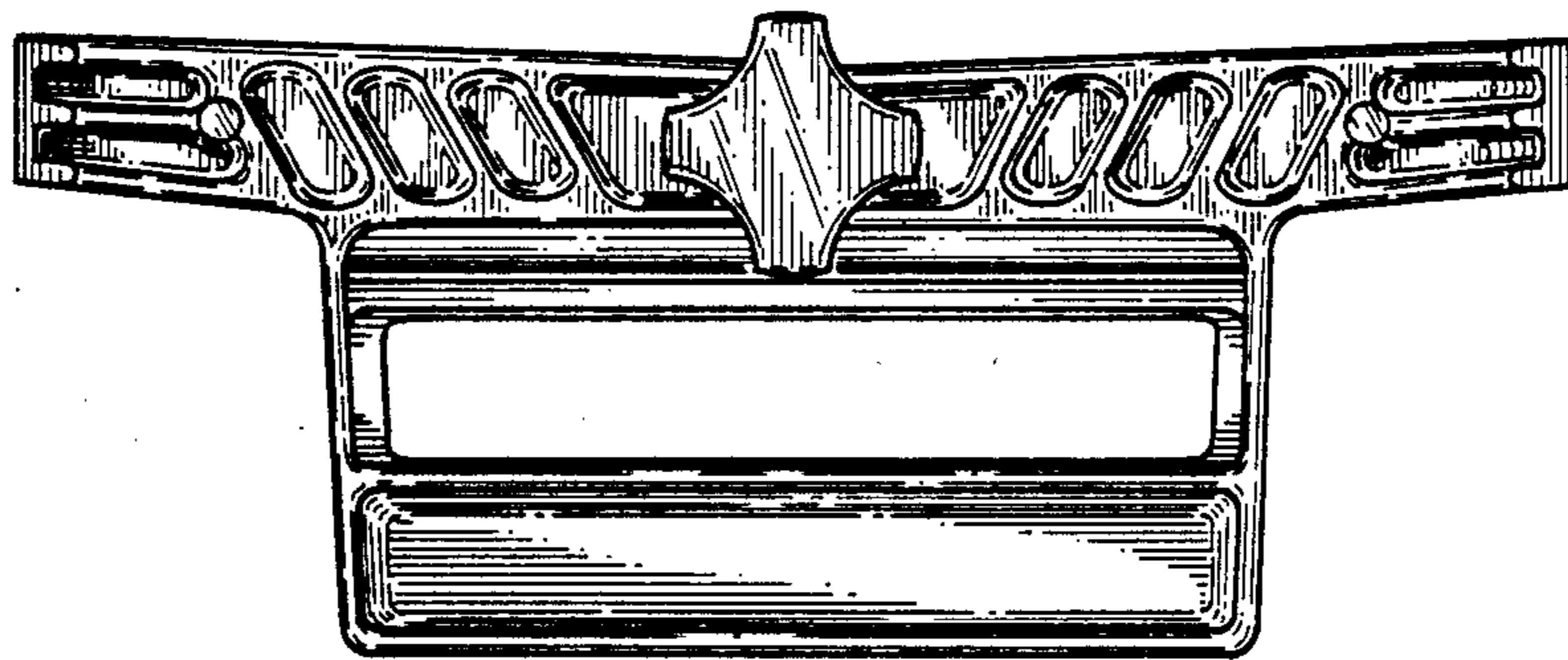
*Fig. 3*



*Fig. 4*



*Fig. 5*



*Fig. 6*