

[54] COMBINED VOICE AND DATA TERMINAL OR SIMILAR ARTICLE

4,481,382 11/1984 Villa-Real ..... D14/53 X

[75] Inventors: Gihyun Cho, W. Paterson; Michael G. Grisham, Westfield; David F. Prontnicki, Wharton, all of N.J.

Primary Examiner—Susan J. Lucas  
Attorney, Agent, or Firm—Patrick E. Roberts; Erwin W. Pfeifle

[73] Assignee: American Telephone and Telegraph Company, AT&T Bell Laboratories, Murray Hill, N.J.

[57] CLAIM

The ornamental design for a combined voice and data terminal or similar article, substantially as shown and described.

[\*\*] Term: 14 Years

DESCRIPTION

[21] Appl. No.: 712,408

FIG. 1 is a front isometric view of a combined voice and data terminal or similar article showing our new design;

[22] Filed: Mar. 15, 1985

FIG. 2 is a rear isometric view thereof;

[52] U.S. Cl. .... D14/100; D14/64; D14/101

FIG. 3 is a front elevational view thereof on an enlarged scale;

[58] Field of Search ..... D14/100, 102, 107, 106, D14/114, 101; 364/708; D18/7; D13/12, 40, 41; 340/700, 365 R

FIG. 4 is a rear elevational view thereof on an enlarged scale;

FIG. 5 is a left side elevational view thereof on an enlarged scale;

[56] References Cited

U.S. PATENT DOCUMENTS

- D. 239,287 3/1976 Ault ..... D14/100
- D. 283,711 5/1986 Deura et al. .... D14/100
- 4,005,388 1/1977 Morley et al. .... 340/365 R X
- 4,268,721 5/1981 Nielson et al. .... D14/64 X

FIG. 6 is a right side elevational view thereof on an enlarged scale;

FIG. 7 is a top plan view thereof on an enlarged scale; and

FIG. 8 is a bottom plan view thereof on an enlarged scale.

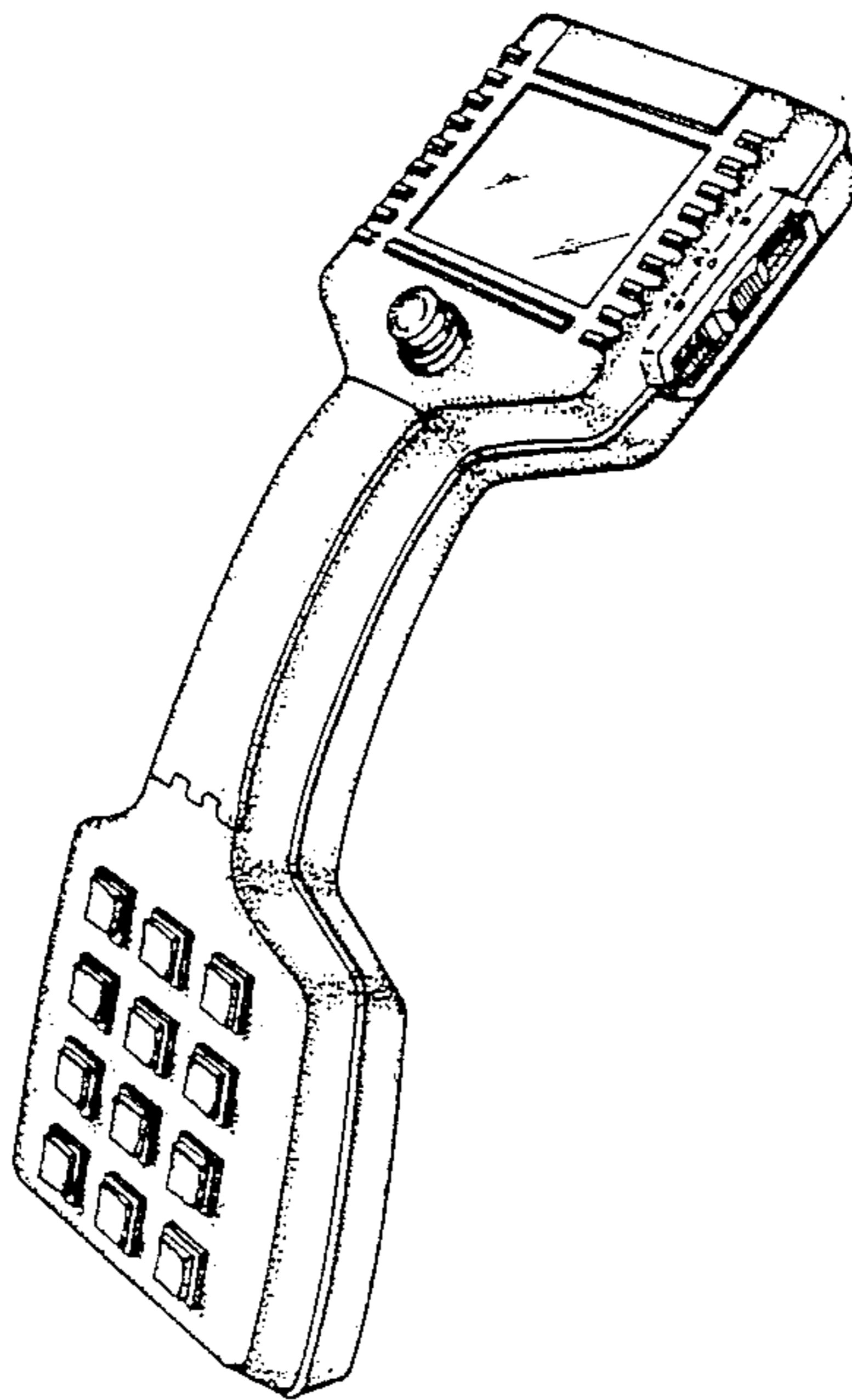

FIG. 1

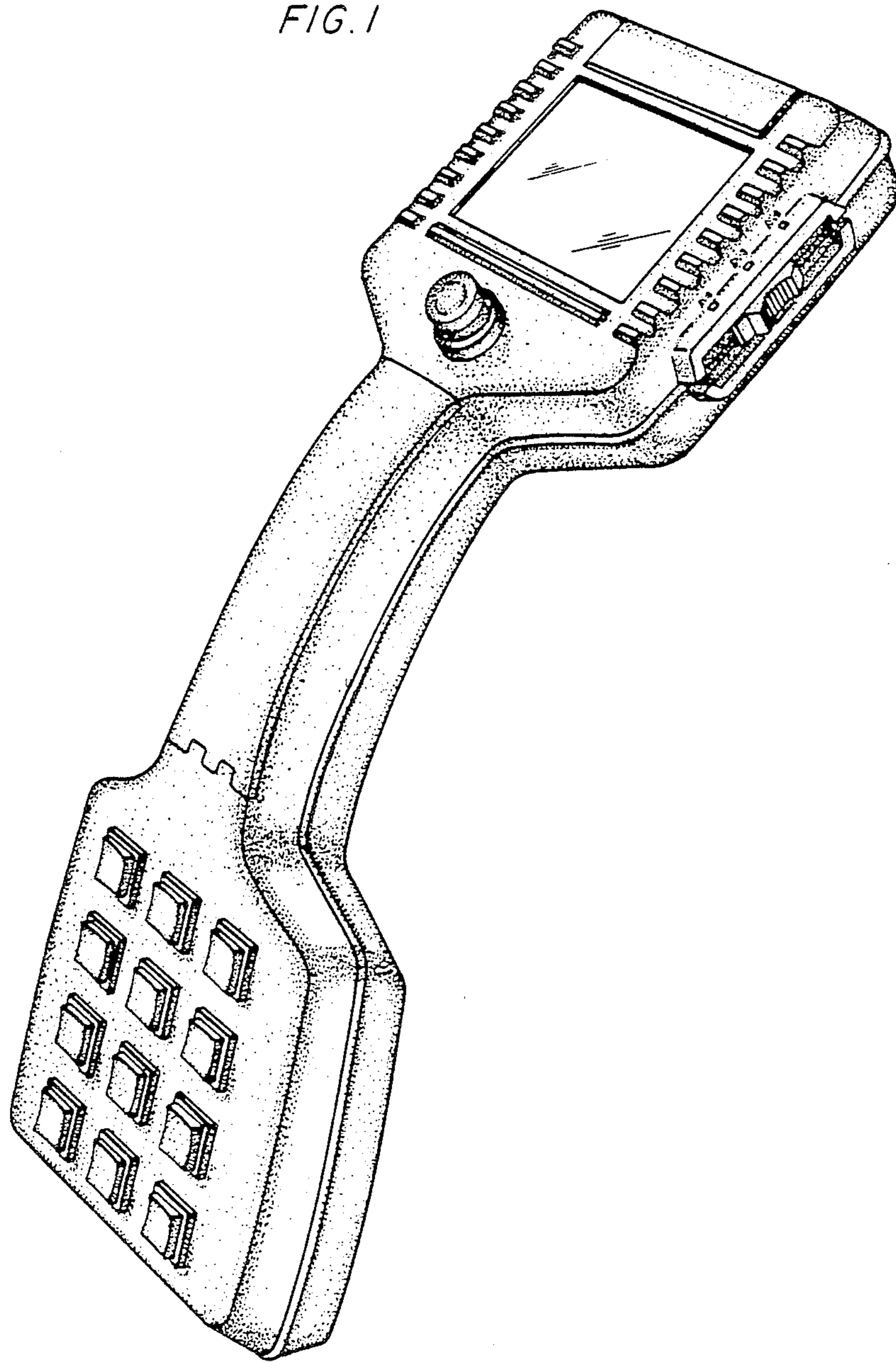

FIG. 2

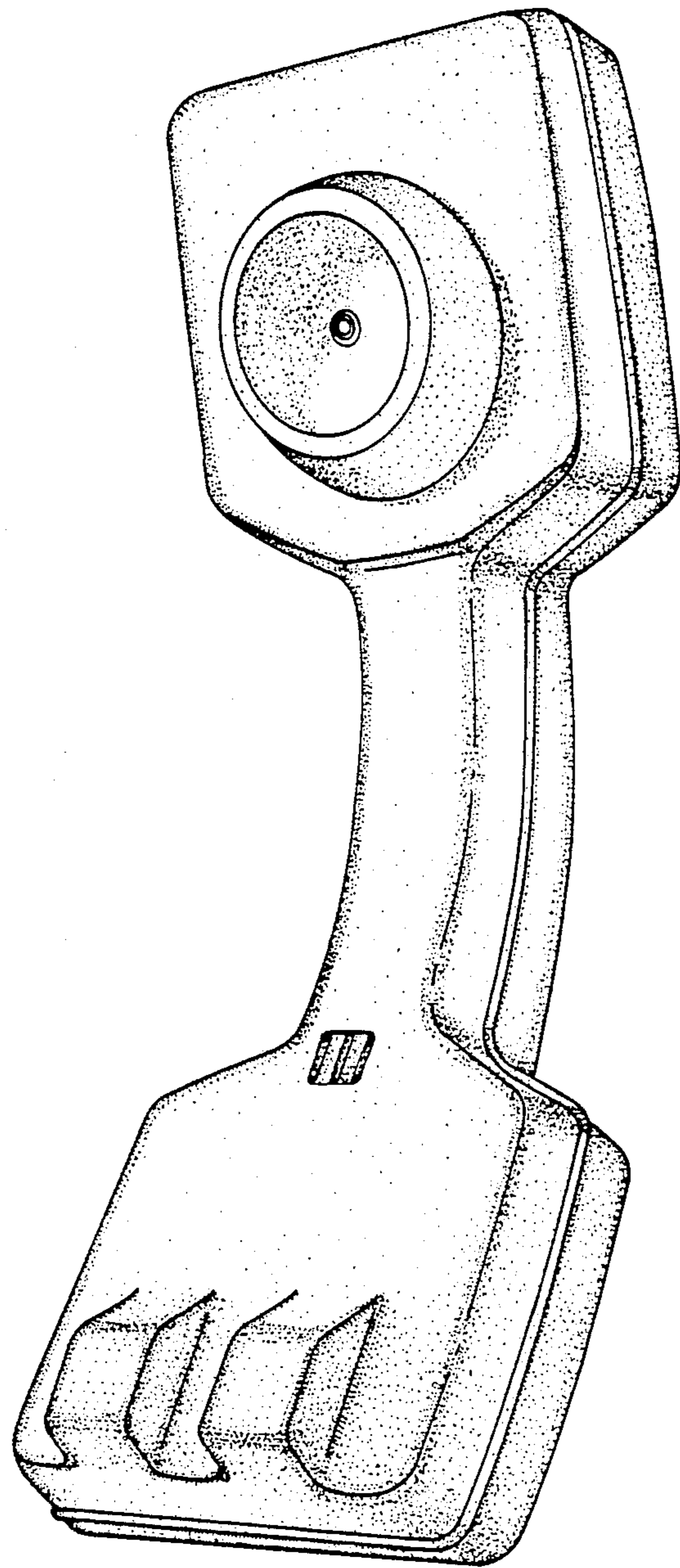

FIG. 3

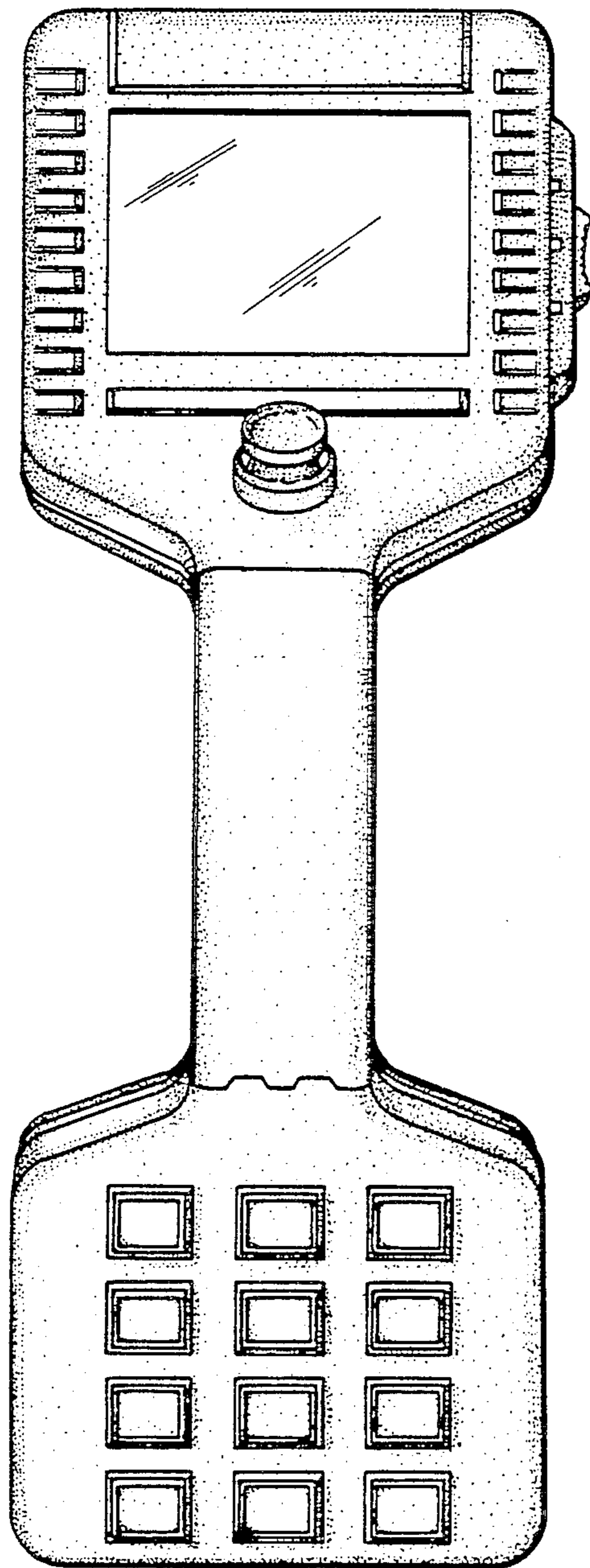



FIG. 4

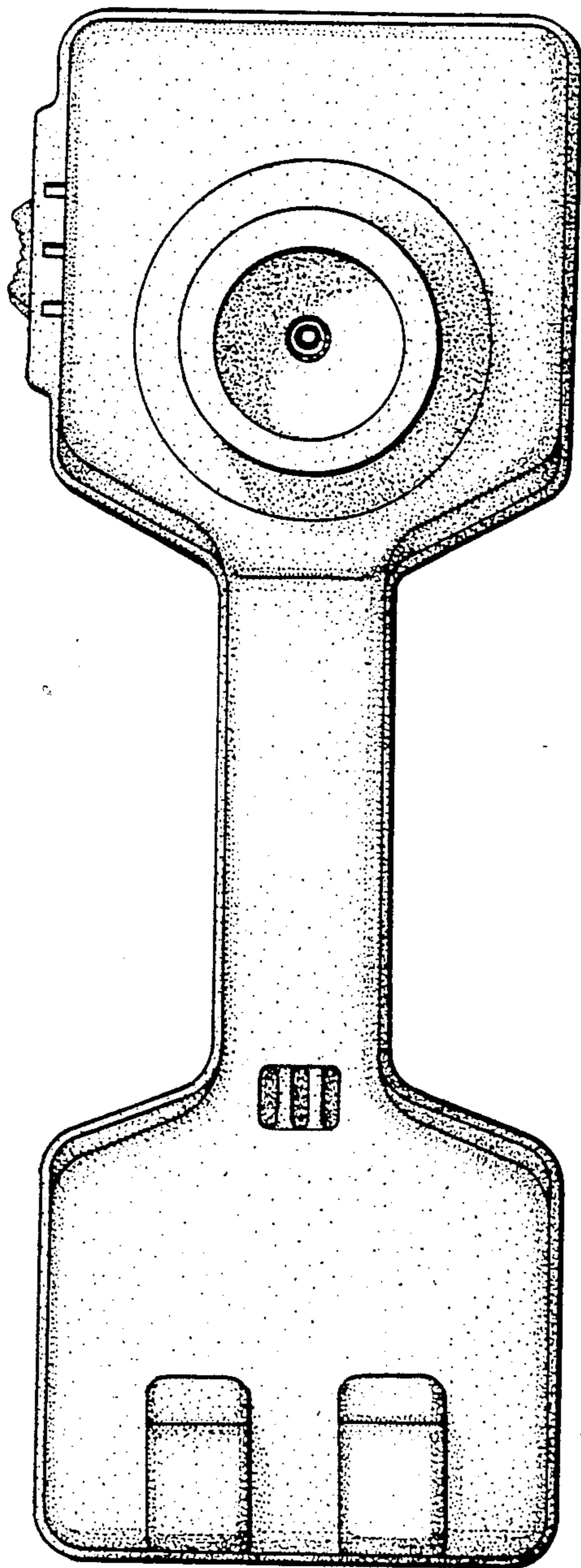

FIG. 5

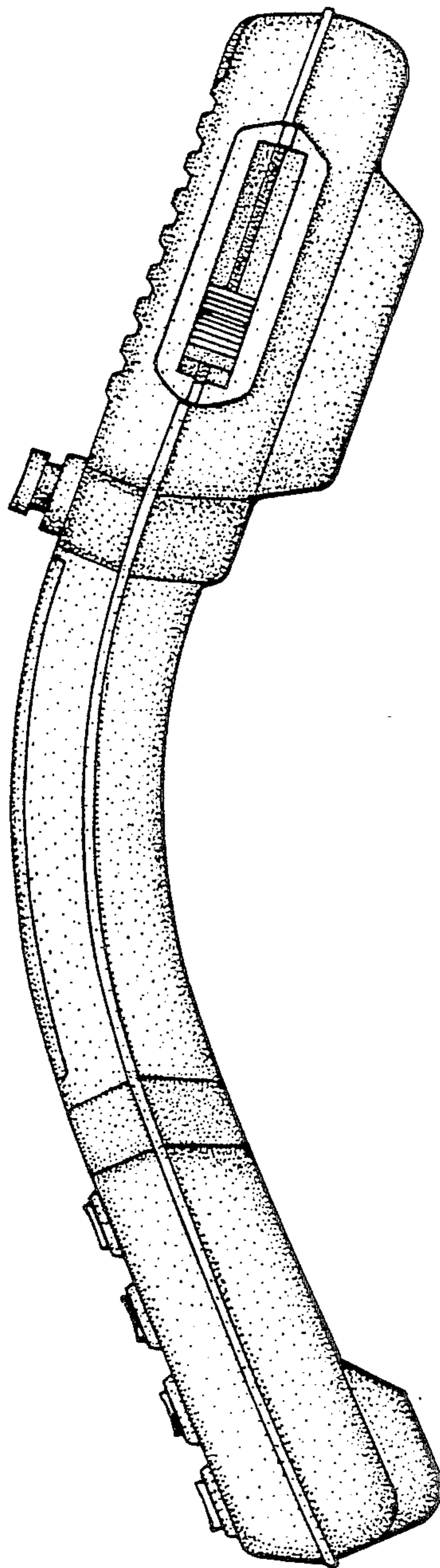

FIG. 6

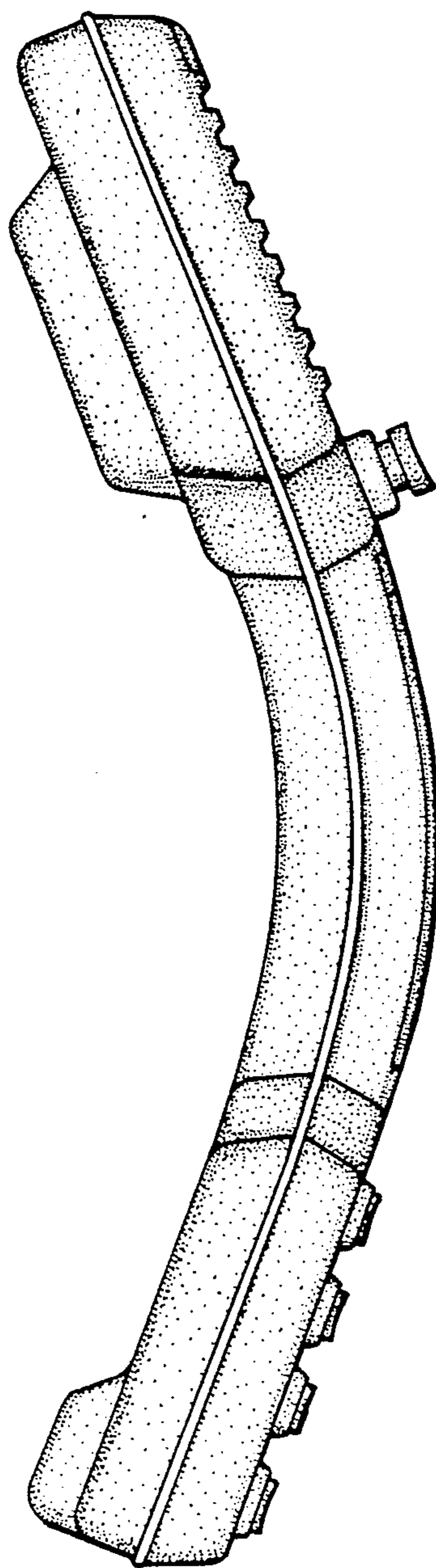

FIG. 7

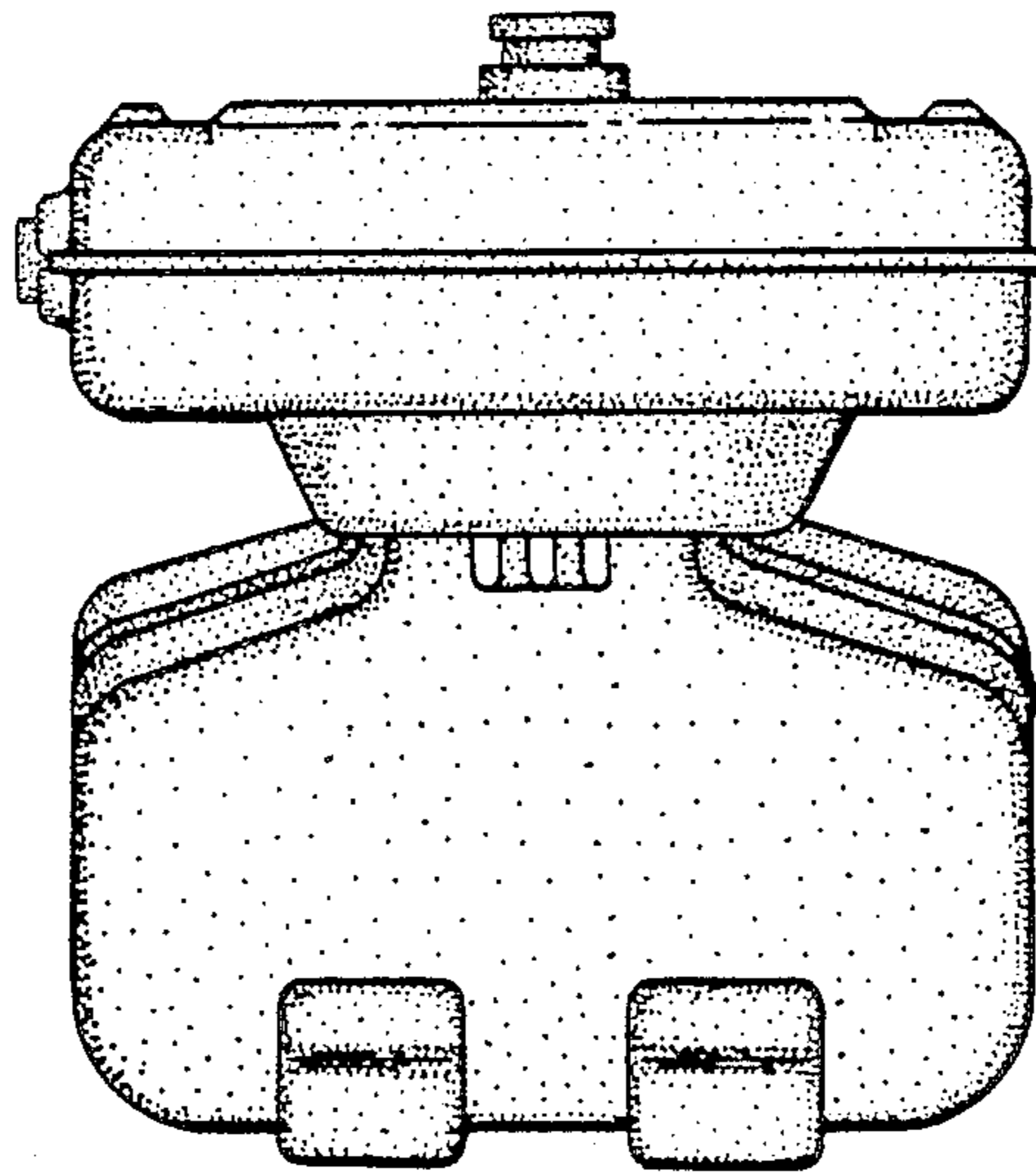

FIG. 8

