

[54] DOOR CLOSER

[75] Inventors: Yasunori Ishizuka, Hiroshima;  
Tosiaki Saito, Tokyo, both of Japan

[73] Assignee: Ryobi Ltd., Tokyo, Japan

[\*\*] Term: 14 Years

[21] Appl. No.: 899,362

[22] Filed: Aug. 22, 1986

[30] Foreign Application Priority Data

Feb. 27, 1986 [JP] Japan ..... 61-7047

[52] U.S. Cl. .... D8/330

[58] Field of Search ..... D8/330-346;  
16/49, 66-68, 71, 82, 84, DIG. 9, DIG. 21

[56] References Cited

U.S. PATENT DOCUMENTS

D. 130,226 11/1941 Holland et al. .... D8/330

D. 162,977 4/1951 Nettleton et al. .... D8/330  
D. 182,977 6/1958 Rollitt ..... D8/330  
D. 271,845 12/1983 Matsuo et al. .... D8/330  
D. 291,771 9/1987 Vandergeest ..... D8/330

Primary Examiner—Susan J. Lucas  
Assistant Examiner—Brian N. Vinson  
Attorney, Agent, or Firm—Sughrue, Mion, Zinn,  
Macpeak & Seas

[57] CLAIM

The ornamental design for a door closer, as shown.

DESCRIPTION

FIG. 1 is a front elevational view of a door closer showing our new design;  
FIG. 2 is a right side elevational view thereof;  
FIG. 3 is a top plan view thereof;  
FIG. 4 is a left side elevational view thereof;  
FIG. 5 is a rear elevational view thereof; and  
FIG. 6 is a bottom plan view thereof.

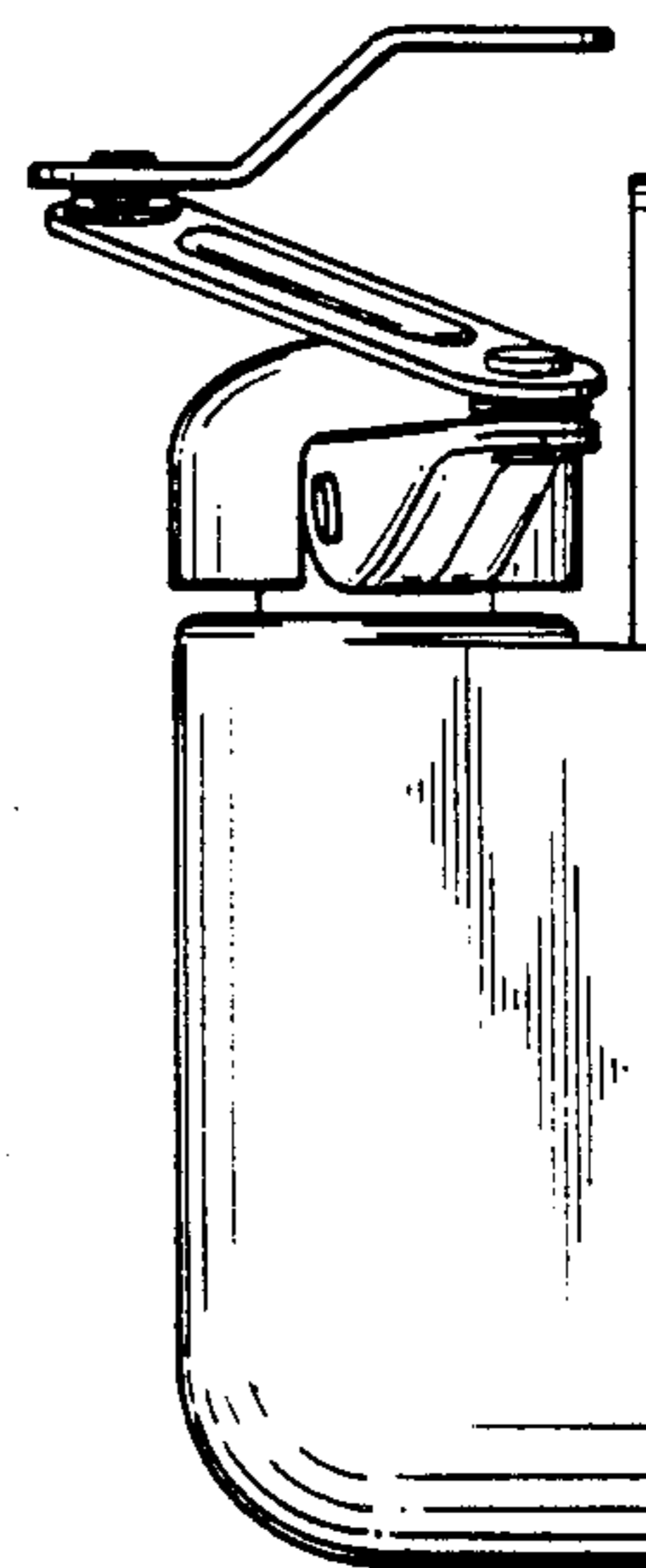
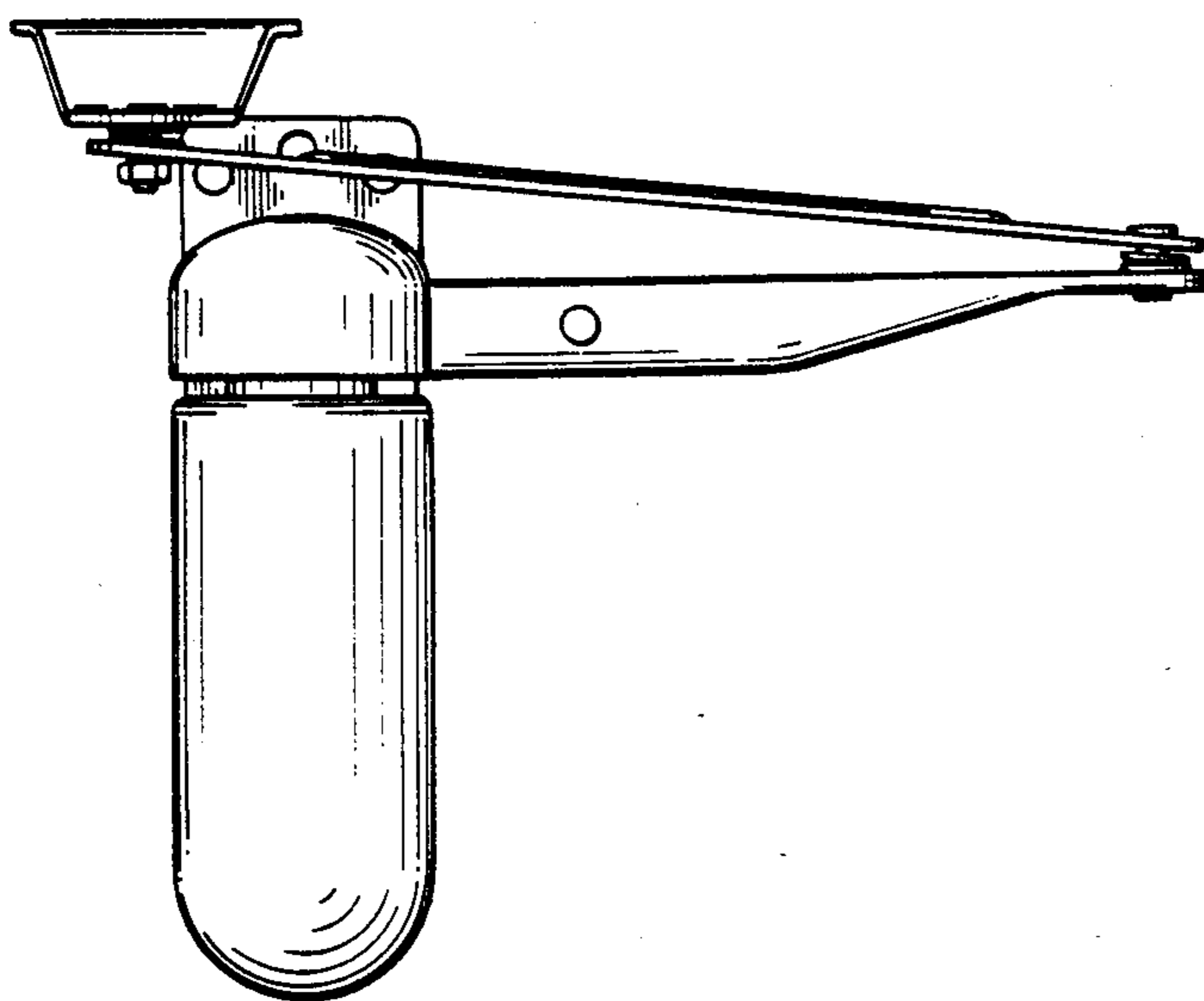

FIG. 1

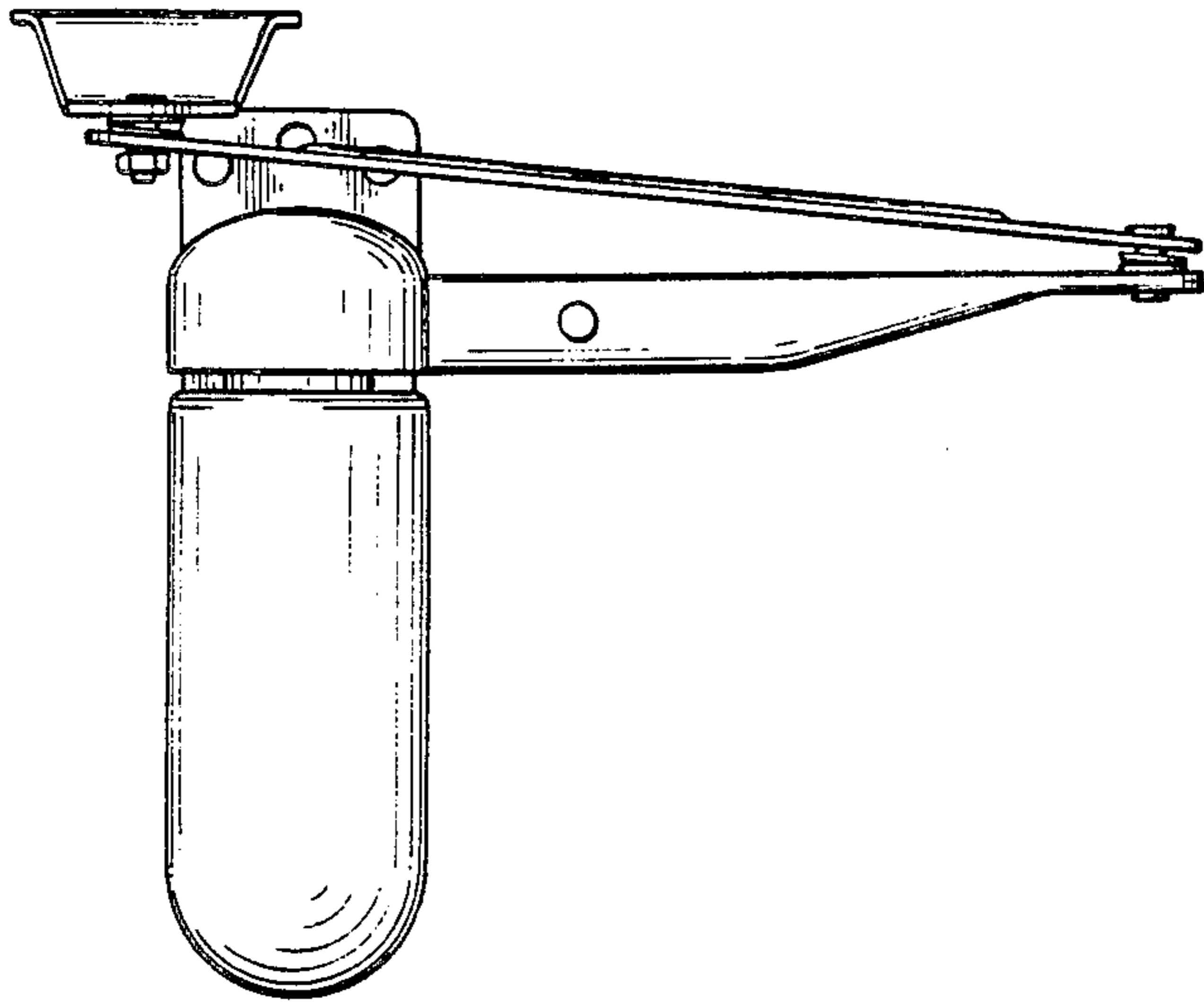

FIG. 2

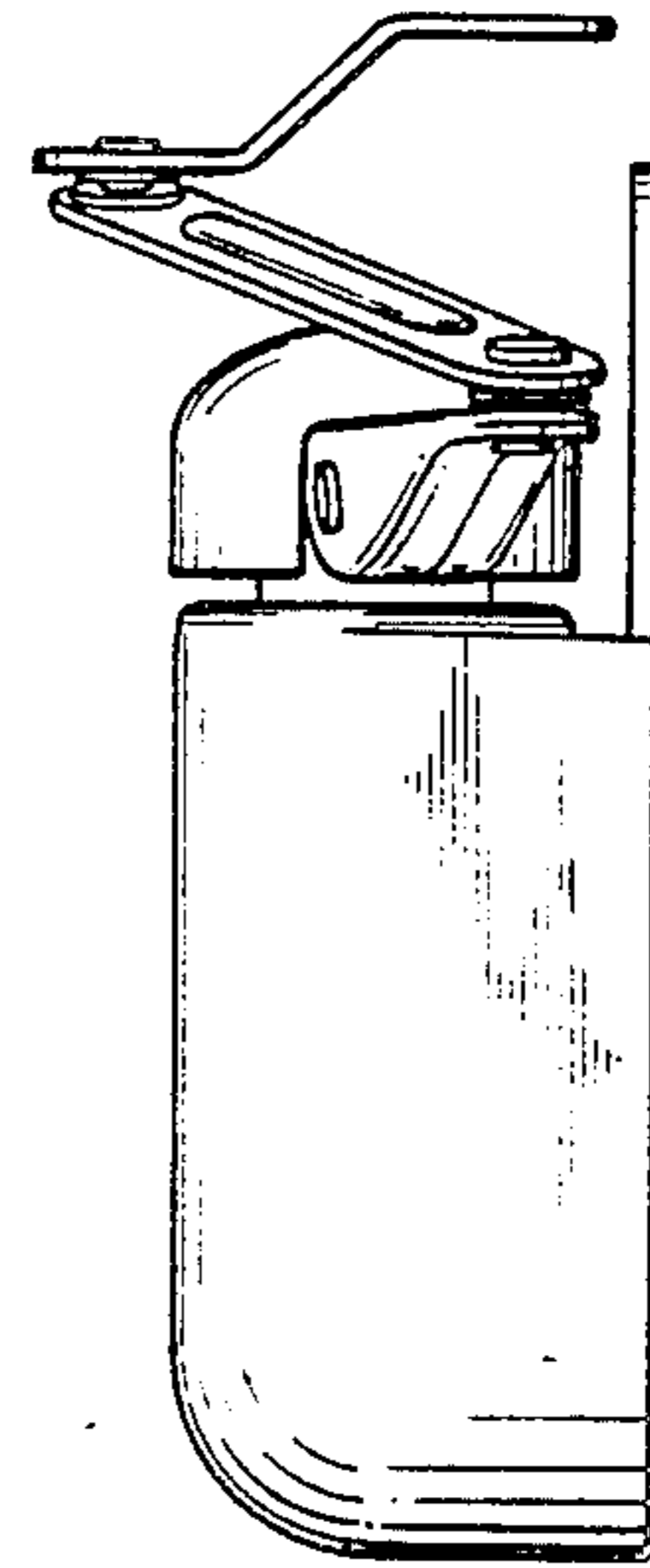

FIG. 3

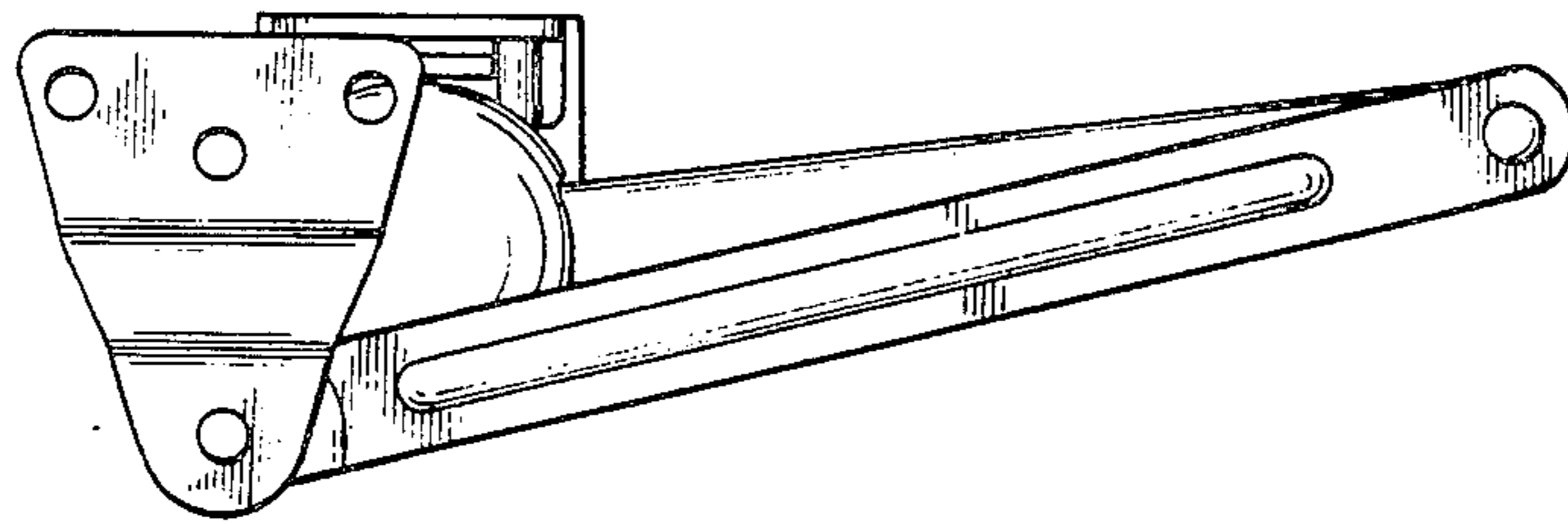

FIG. 4

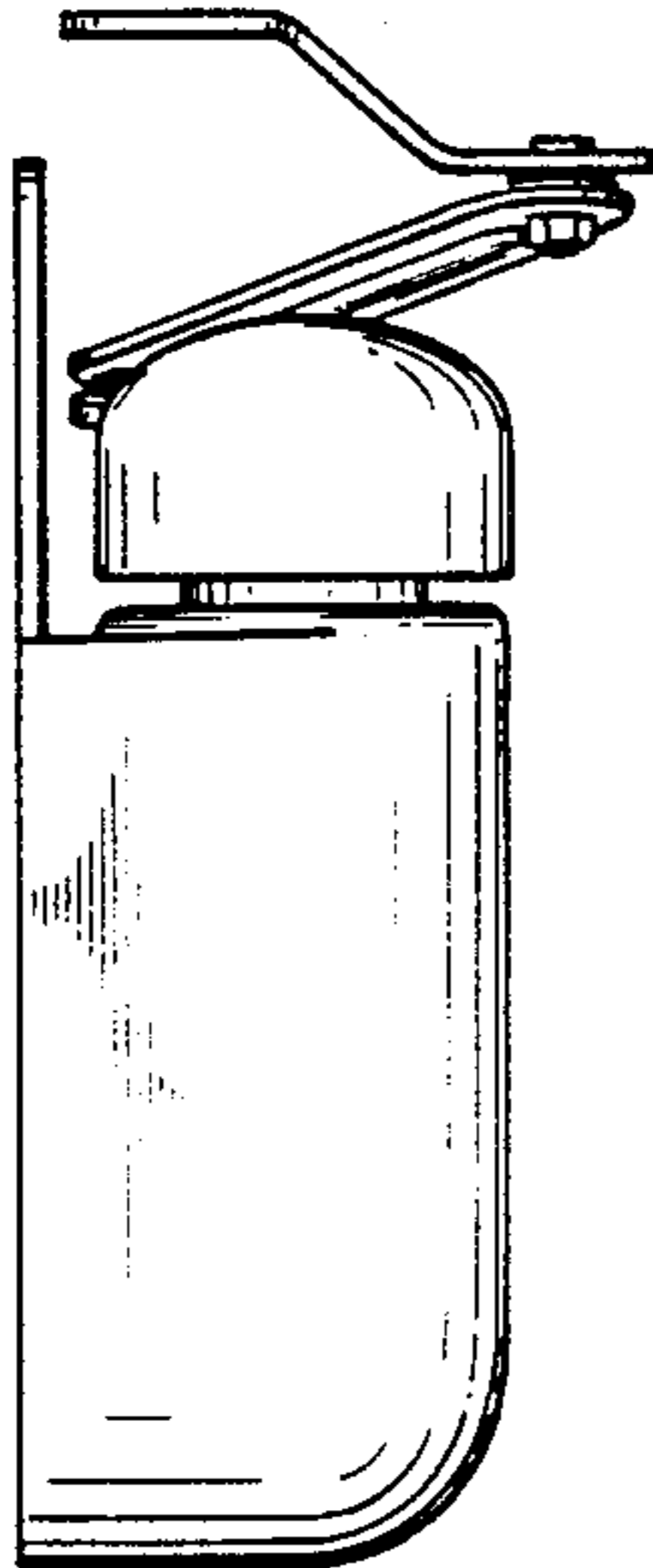

FIG. 5

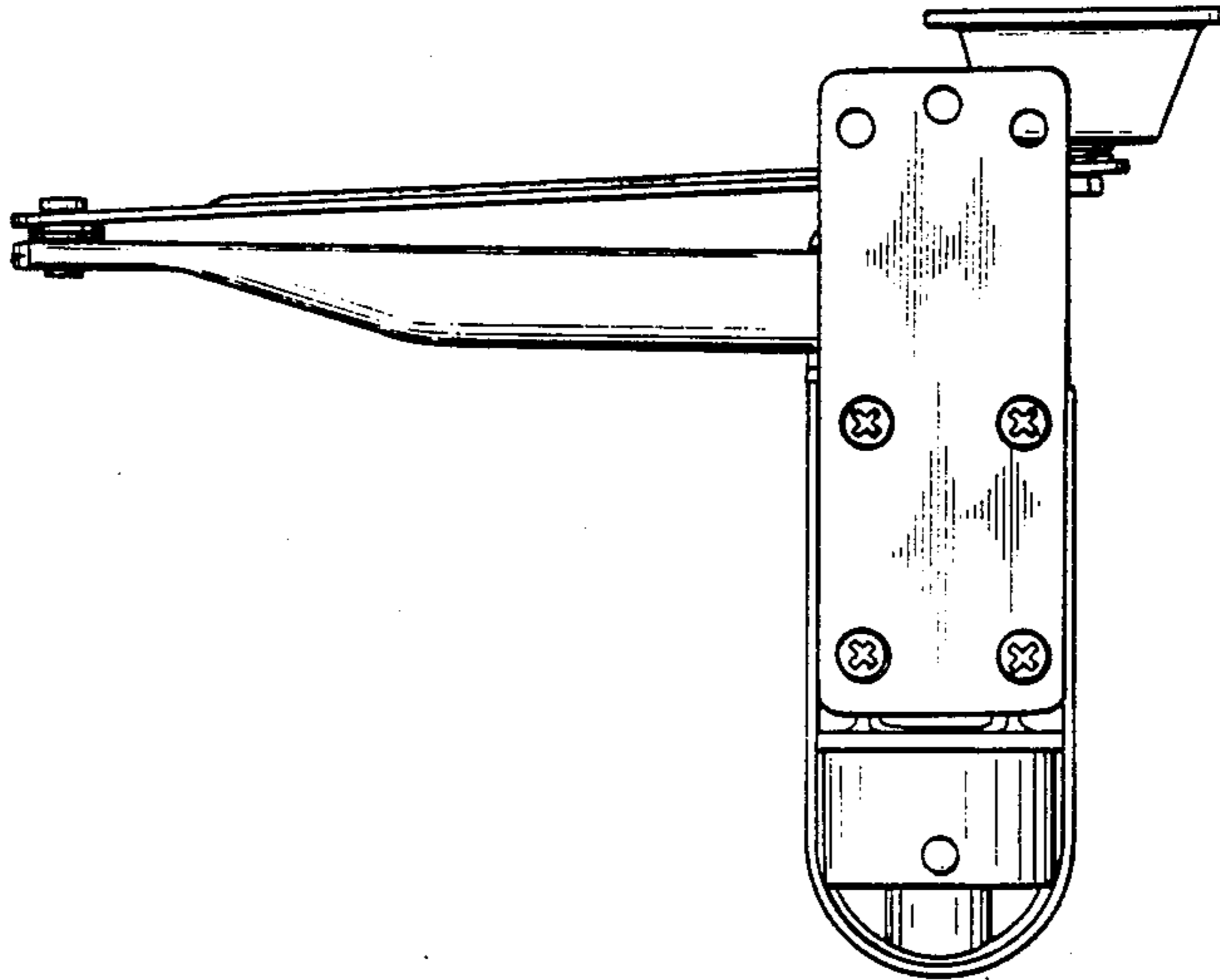

FIG. 6

