

[54] OIL-FIRED SPACE HEATER

[75] Inventor: Kazuharu Nakamura, Aichi, Japan

[73] Assignee: Toyotomi Kogyo Co., Ltd., Aichi, Japan

[\*] Notice: The portion of the term of this patent subsequent to Jul. 1, 2000 has been disclaimed.

[\*\*] Term: 14 Years

[21] Appl. No.: 786,112

[22] Filed: Oct. 10, 1985

[30] Foreign Application Priority Data

Apr. 26, 1985 [JP] Japan ..... 60-17546

[52] U.S. Cl. .... D23/338

[58] Field of Search ..... D23/92, 93, 119-124; 126/92-97

[56] References Cited

U.S. PATENT DOCUMENTS

- D. 269,541 6/1983 Nakamura ..... D23/121
- D. 275,880 10/1984 Nakamura ..... D23/121
- D. 282,773 2/1986 Mase et al. .... D23/121
- D. 284,503 7/1986 Nakamura ..... D23/121

Primary Examiner—Catherine E. Kemper  
Attorney, Agent, or Firm—Pollock, Vande Sande & Priddy

[57] CLAIM

The ornamental design for an oil-fired space heater, substantially as shown and described.

DESCRIPTION

FIG. 1 is a front elevational view of an oil-fired space heater showing my new design;

FIG. 2 is a left side elevational view thereof;

FIG. 3 is a top plan view thereof;

FIG. 4 is a right side elevational view thereof;

FIG. 5 is a rear elevational view thereof; and,

FIG. 6 is a bottom plan view thereof.

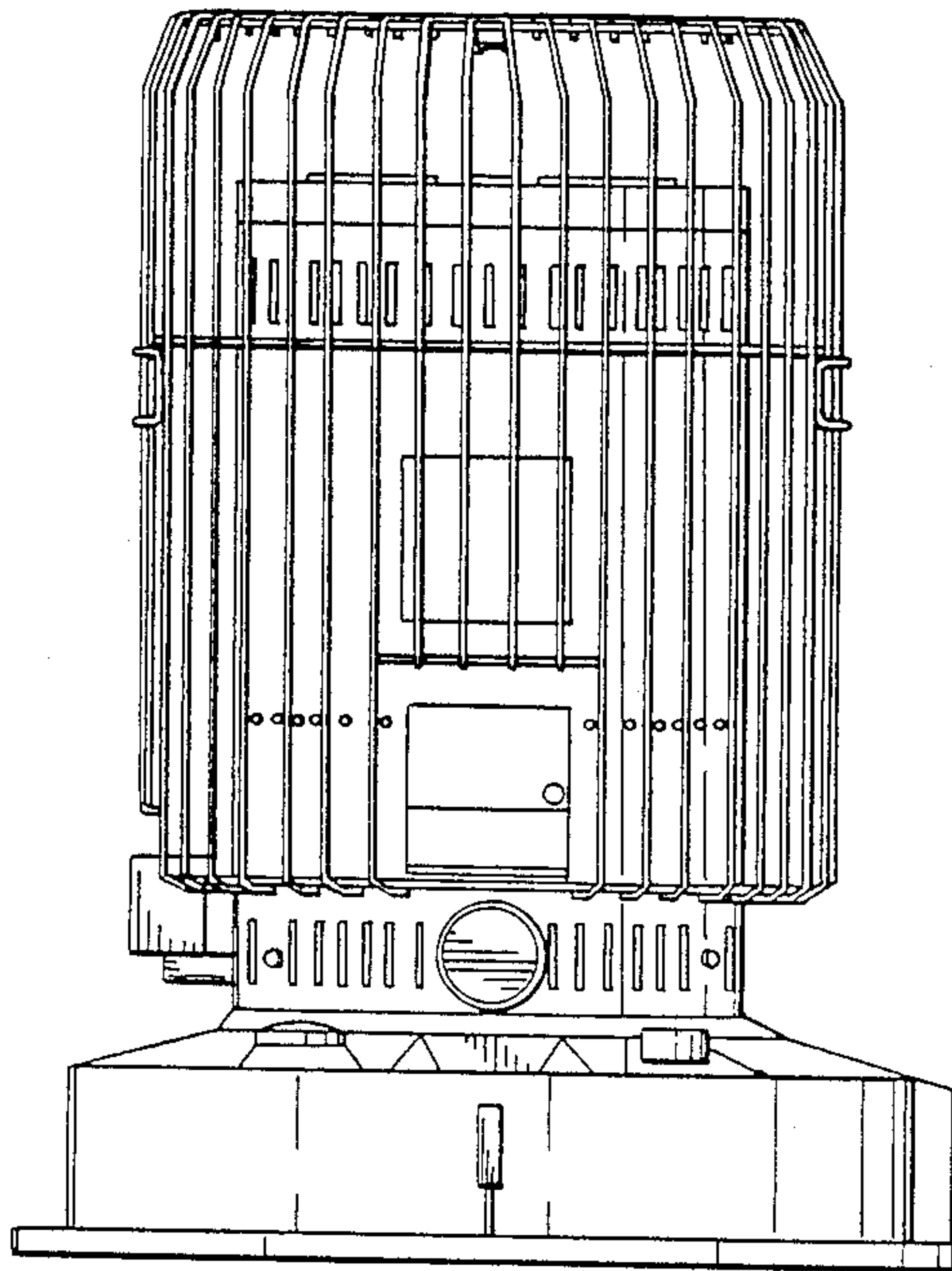

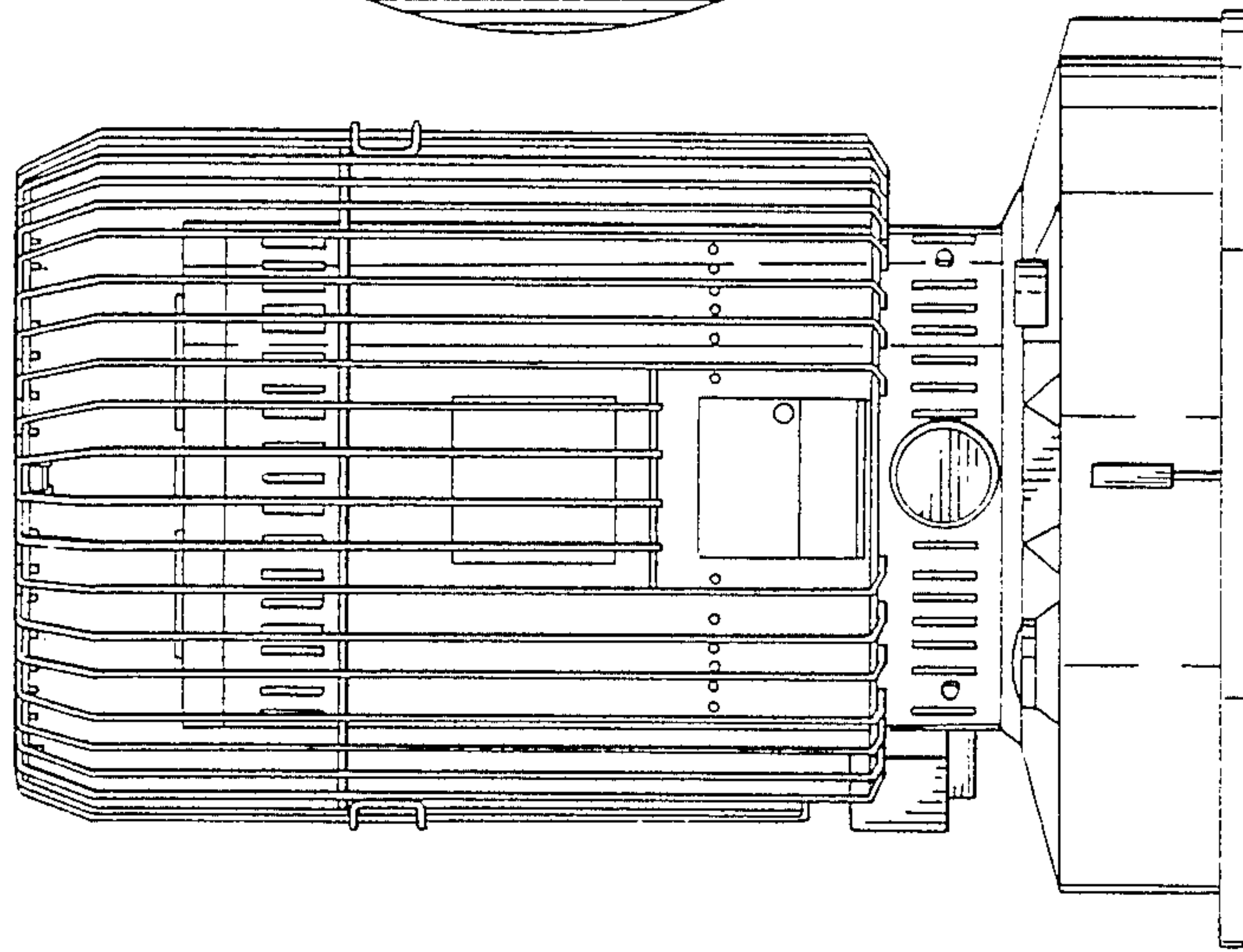

FIG. 1

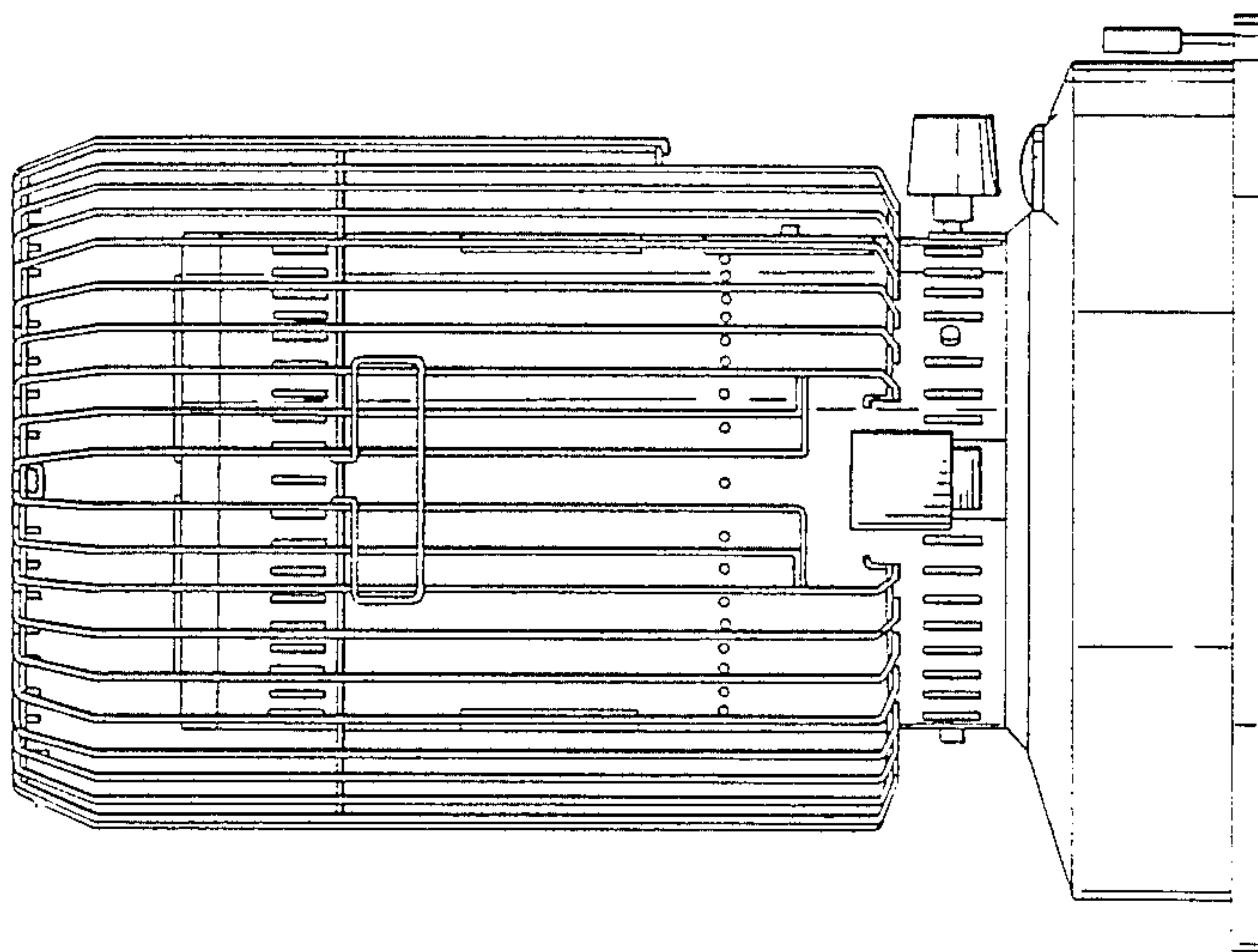

FIG. 2

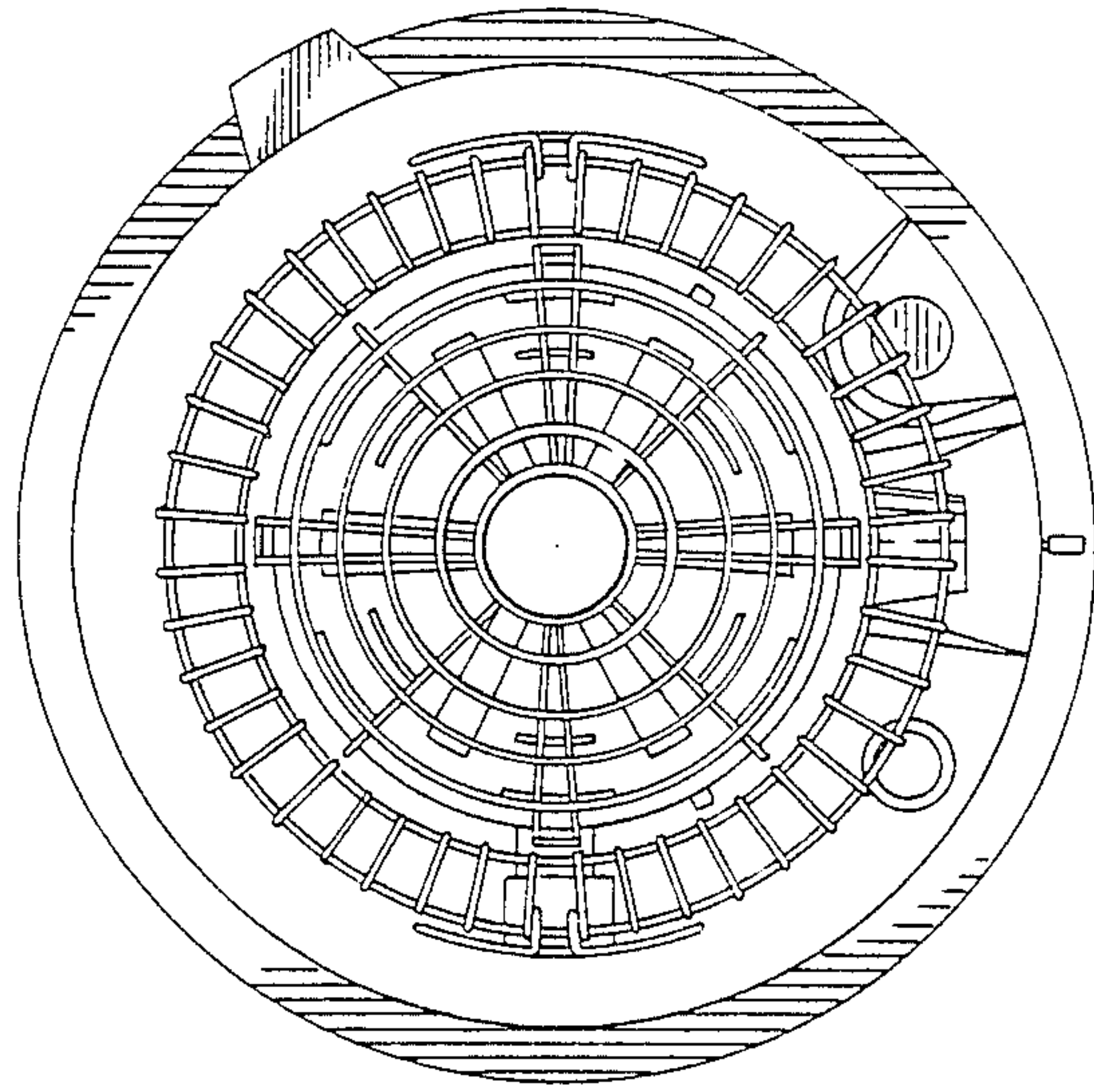

FIG. 3

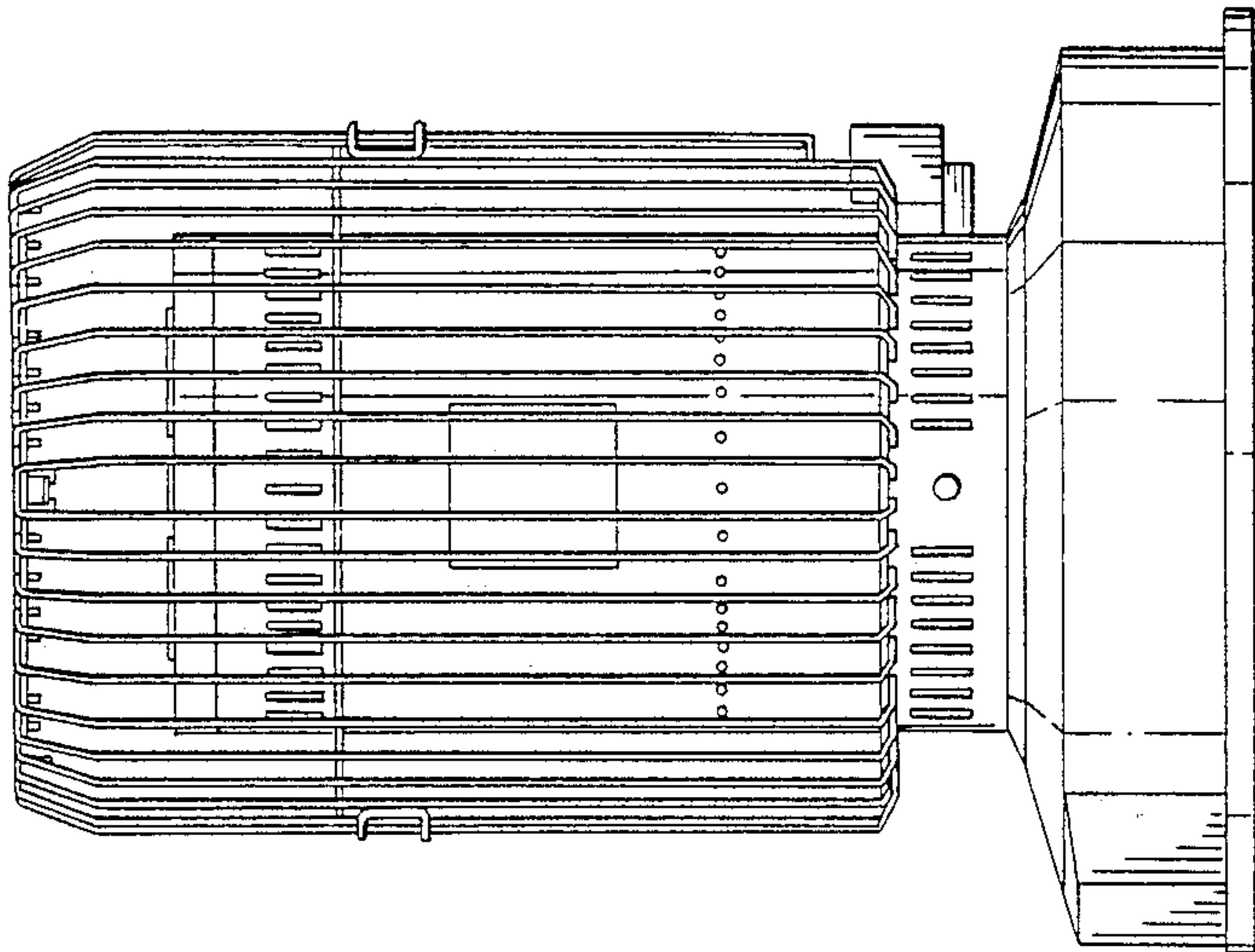

FIG. 5

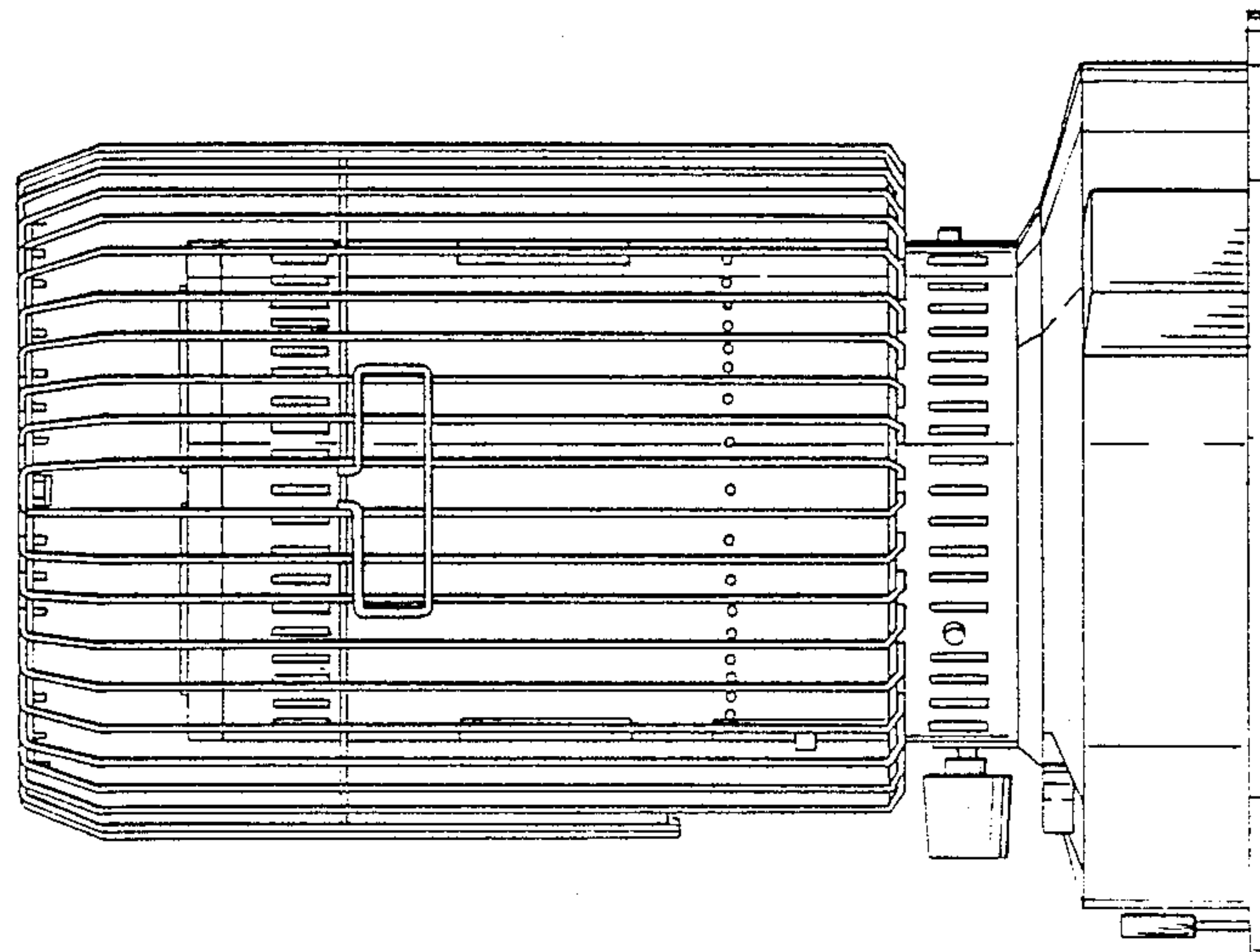

FIG. 4

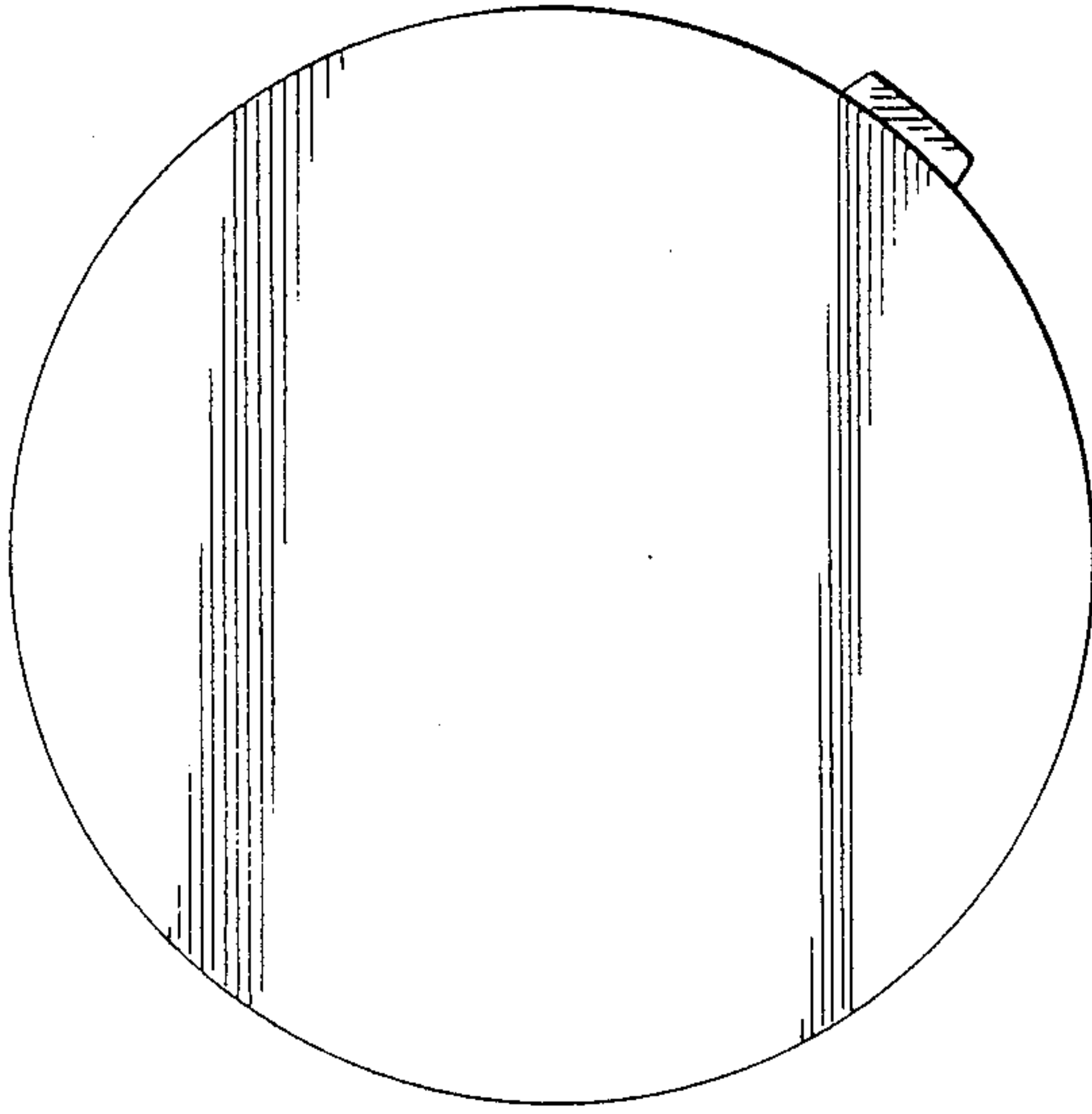

FIG. 6