

[54] **WRIST WATCH**

[75] **Inventor:** Takashi Takeichi, Hamuramachi, Japan

[73] **Assignee:** Casio Computer Co., Ltd., Tokyo, Japan

[**] **Term:** 14 Years

[21] **Appl. No.:** 790,407

[22] **Filed:** Oct. 23, 1985

[30] **Foreign Application Priority Data**

May 14, 1985 [JP] Japan 60-19818

[52] **U.S. Cl.** D10/30; D10/38

[58] **Field of Search** D10/30-39, D10/122-128; 368/276-285, 239-242

[56] **References Cited**

U.S. PATENT DOCUMENTS

D. 265,063 6/1982 Ida D10/38
D. 278,130 3/1985 Houlihan D10/38
D. 290,234 6/1987 Komatsu D10/38

OTHER PUBLICATIONS

Jeweler's Circular-Keystone-8/79-p. 18-Watch at bottom.

Hong Kong Enterprises-11/81-p. 79-Watches at center.
European Jeweler-2/83-p. 90-Watches at top, and bottom-right.

Primary Examiner-Nelson C. Holtje
Attorney, Agent, or Firm-Frishauf, Holtz, Goodman & Woodward

[57] **CLAIM**

The ornamental design for a wrist watch, substantially as shown.

DESCRIPTION

FIG. 1 is a front elevational view of a wrist watch showing my new design;

FIG. 2 is a top plan view thereof;

FIG. 3 is a right side elevational view thereof;

FIG. 4 is a left side elevational view thereof;

FIG. 5 is a bottom plan view thereof;

FIG. 6 is a rear elevational view thereof; and

FIG. 7 is a perspective view thereof.

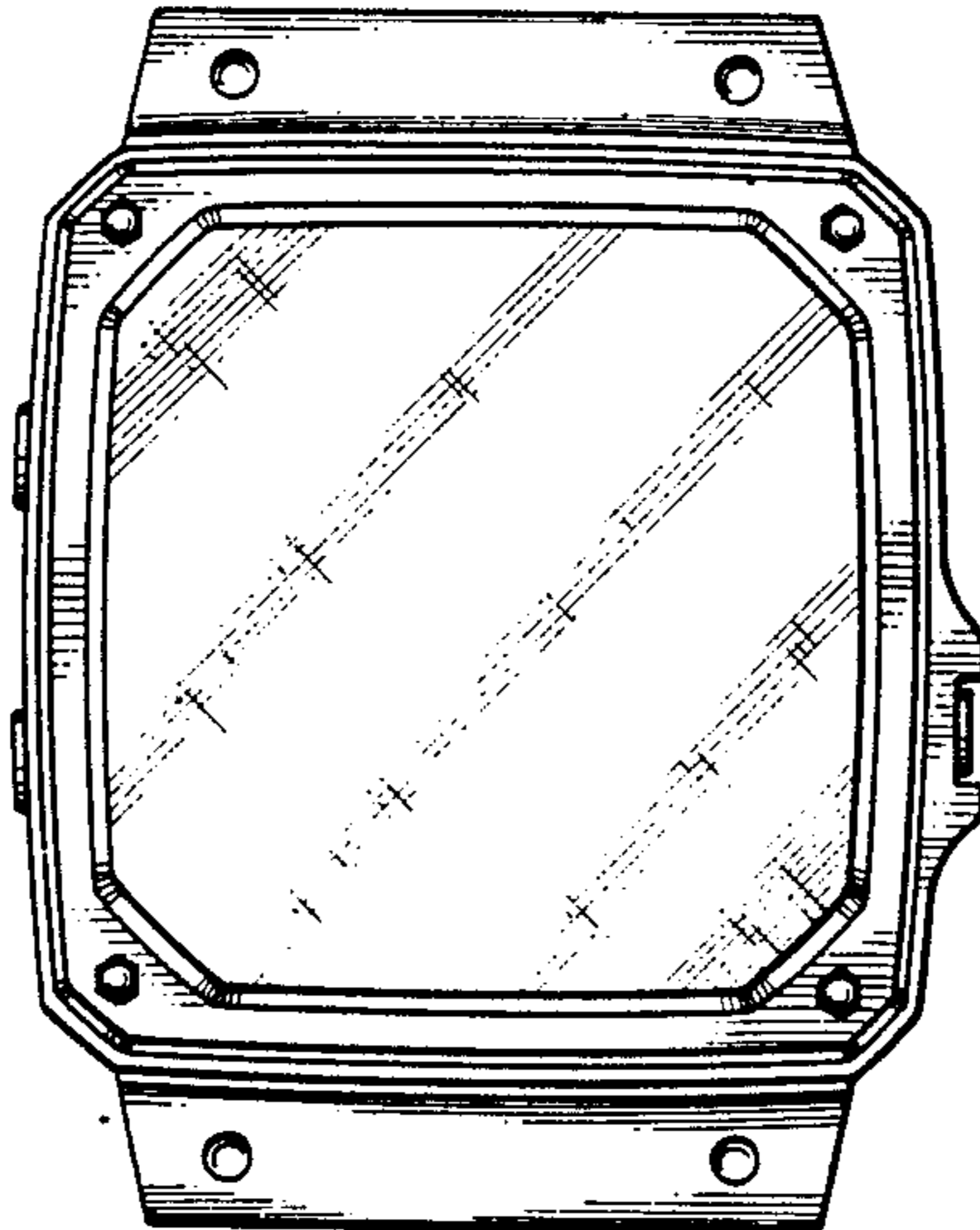

FIG. 1

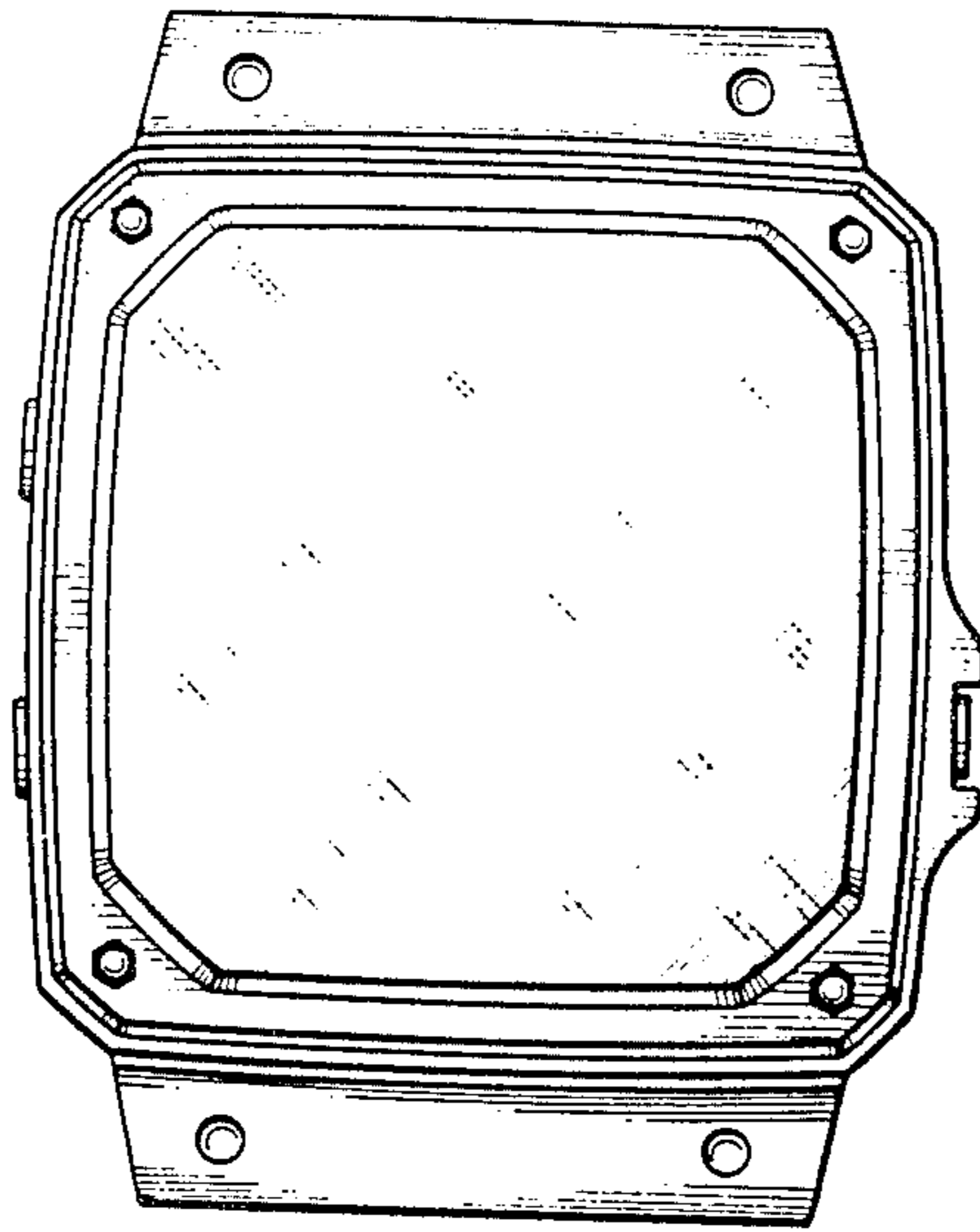

FIG. 2

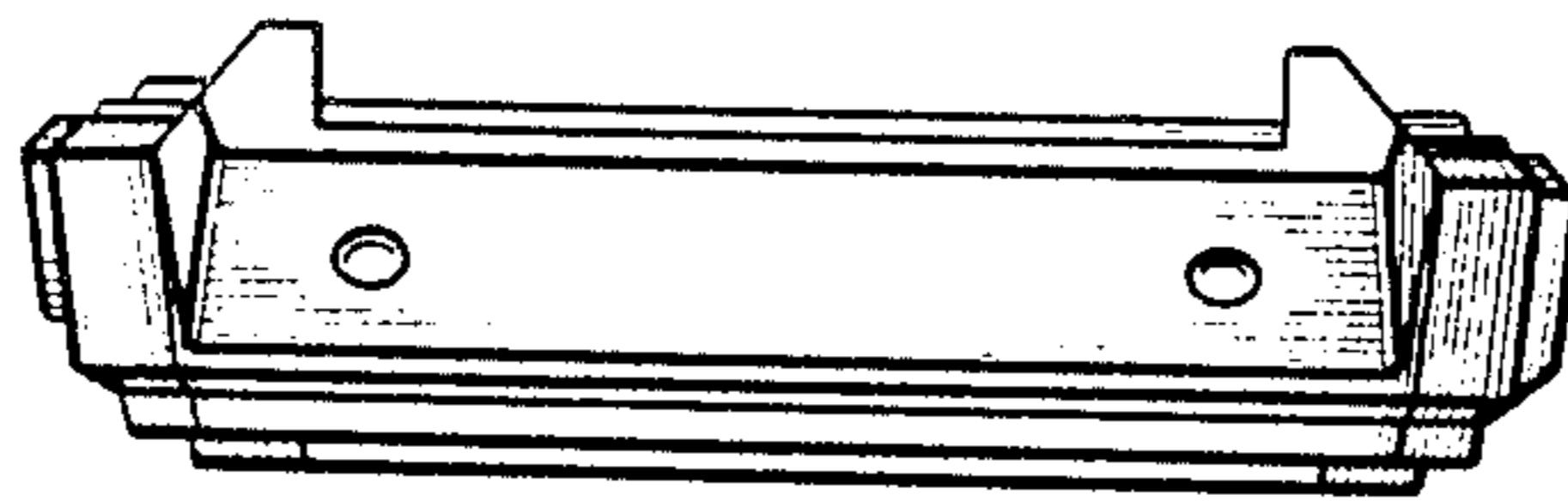

FIG. 4

FIG. 3

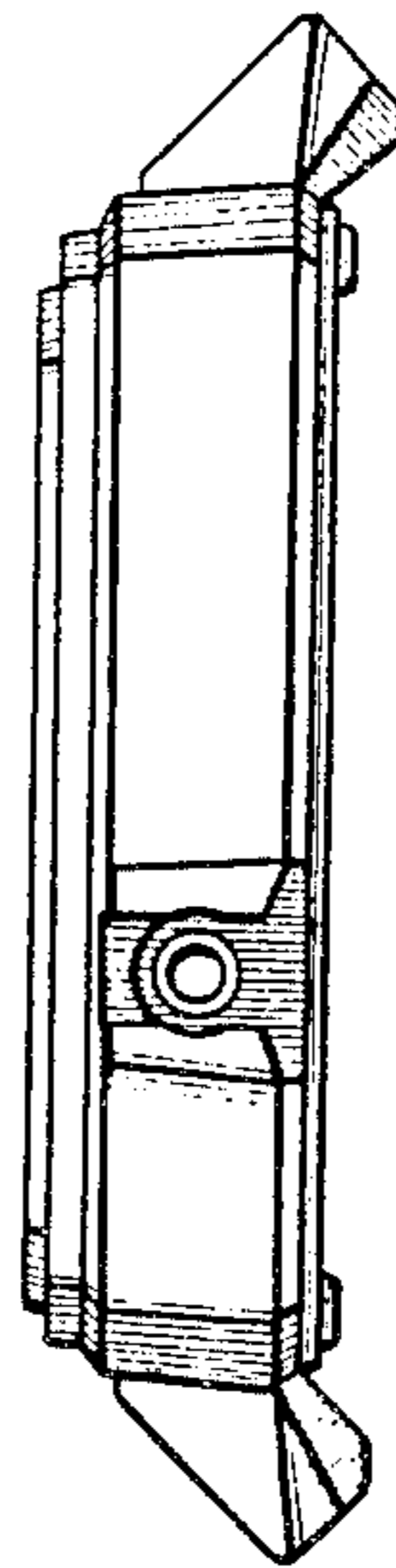
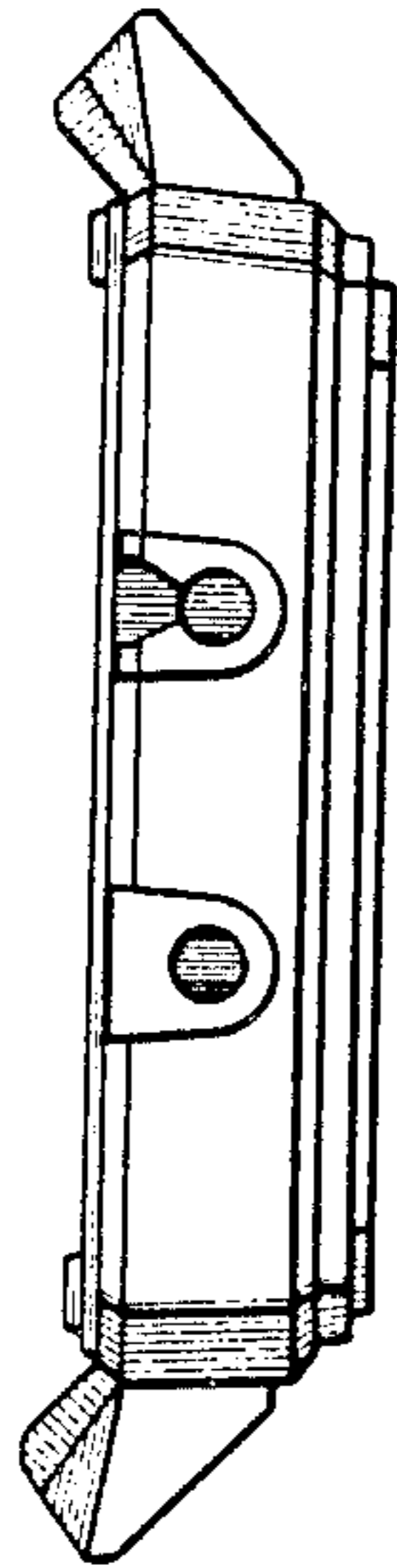

FIG. 5

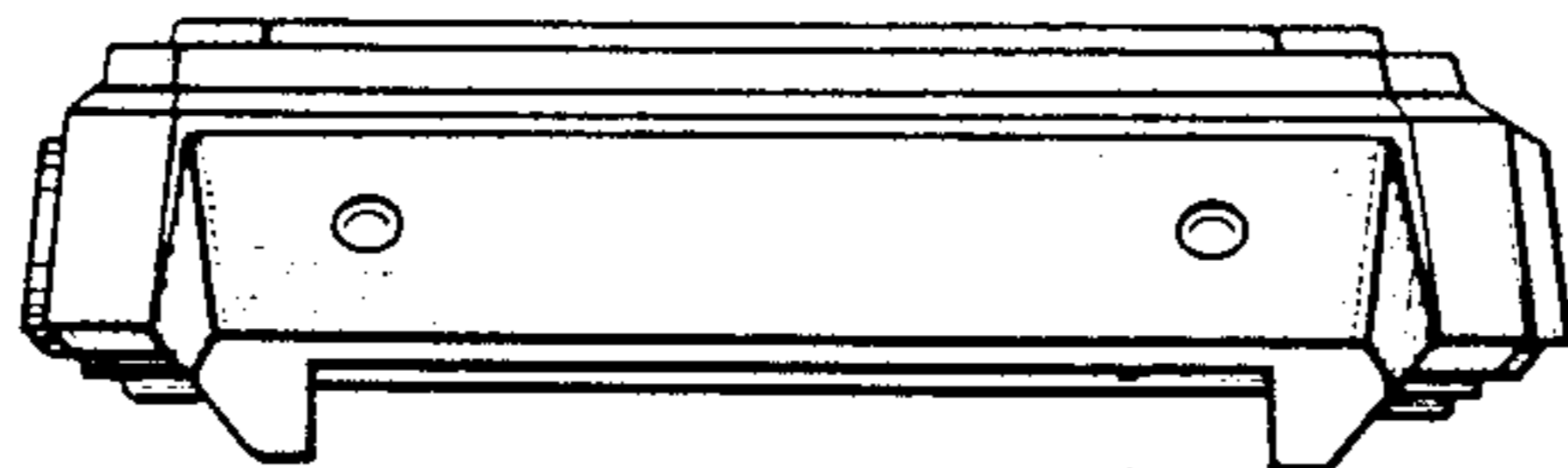

FIG. 6

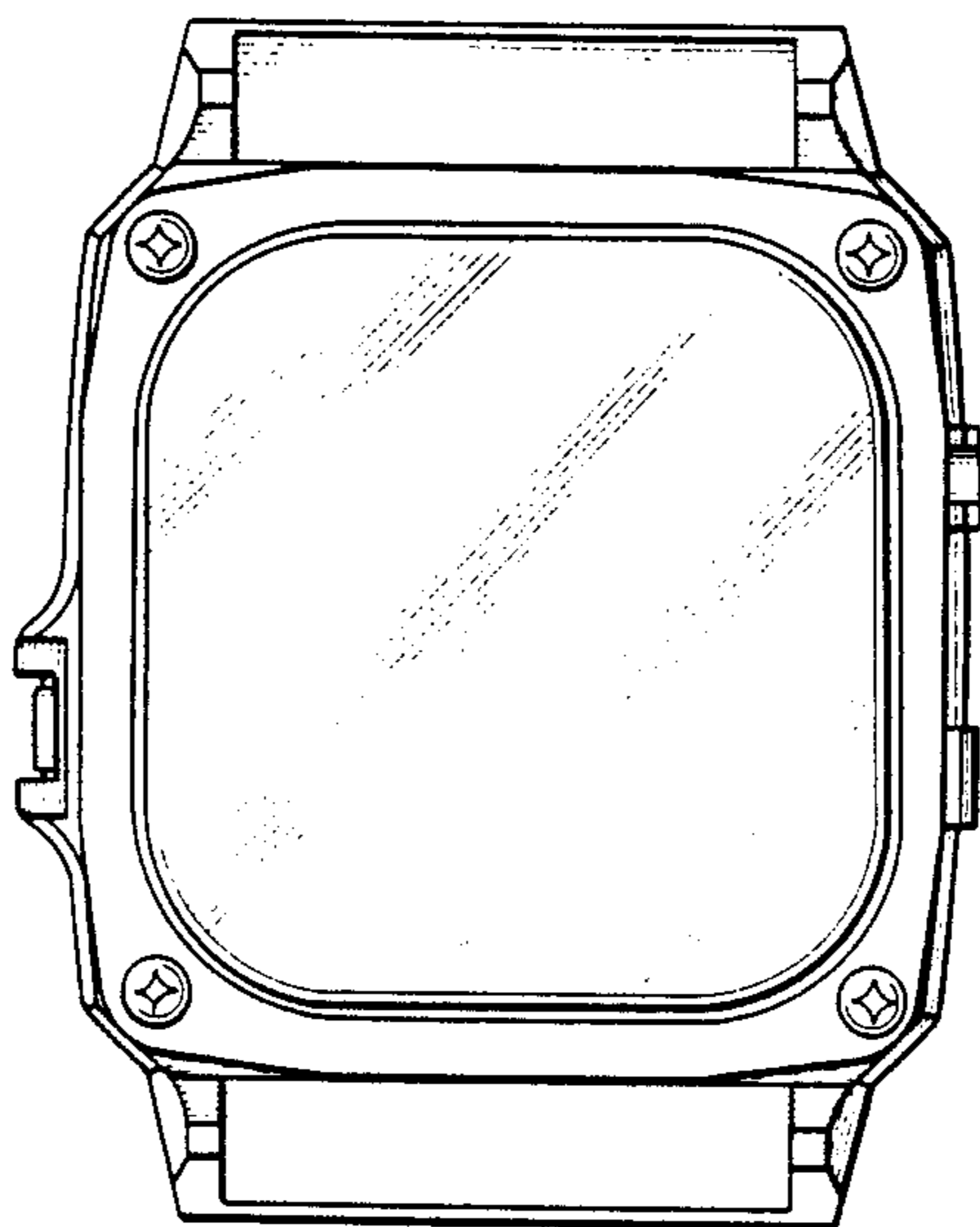

FIG. 7

