

[54] COLLAPSIBLE HAMMOCK STAND

35773 7/1912 Sweden 5/128

[76] Inventors: Larry Frick, 913 Woodlawn Ave.;
Harrison R. Thompson, 415
Woodlands Rd., both of Columbia,
S.C. 29209

Primary Examiner—Carmen H. Vales
Attorney, Agent, or Firm—Newton, Hopkins & Ormsby

[**] Term: 14 Years

[57] CLAIM

The ornamental design for a collapsible hammock stand, as shown and described.

[21] Appl. No.: 805,050

DESCRIPTION

[22] Filed: Nov. 12, 1985

[52] U.S. Cl. D6/387

[58] Field of Search D6/386, 387; 5/127,
5/128, 130

FIG. 1 is a perspective view of a collapsible hammock stand showing our new design;
FIG. 2 is a top plan view;
FIG. 3 is a front elevational view, the rear view being identical thereto;
FIG. 4 is a bottom plan view;
FIG. 5 is a side elevational view, the opposite side being identical thereto;
FIG. 6 is a perspective view in collapsed position;
FIG. 7 is a side elevational view, the opposite side being identical thereto;
FIG. 8 is a front elevational view, the rear view being identical thereto;
FIG. 9 is a top plan view thereof; and
FIG. 10 is a bottom plan view thereof.

[56] References Cited

U.S. PATENT DOCUMENTS

- D. 39,975 5/1909 Hoffman D6/387
- D. 233,708 11/1974 Gresk D6/387
- 240,522 4/1881 Ketcham 5/128
- 340,071 4/1886 Adams 5/128
- 2,353,220 7/1944 Charlop 5/128

FOREIGN PATENT DOCUMENTS

- 2853993 7/1980 Fed. Rep. of Germany 5/127

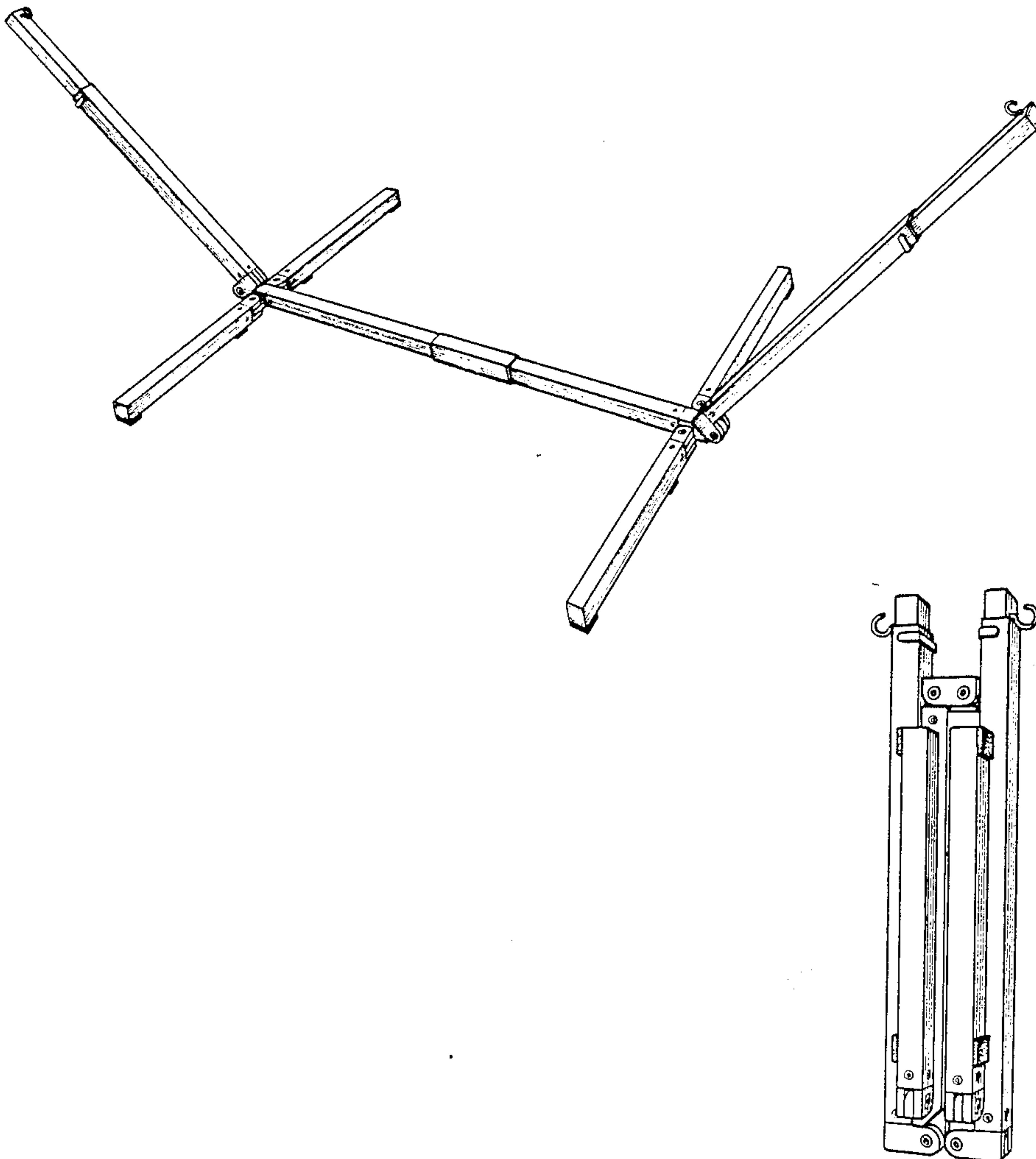

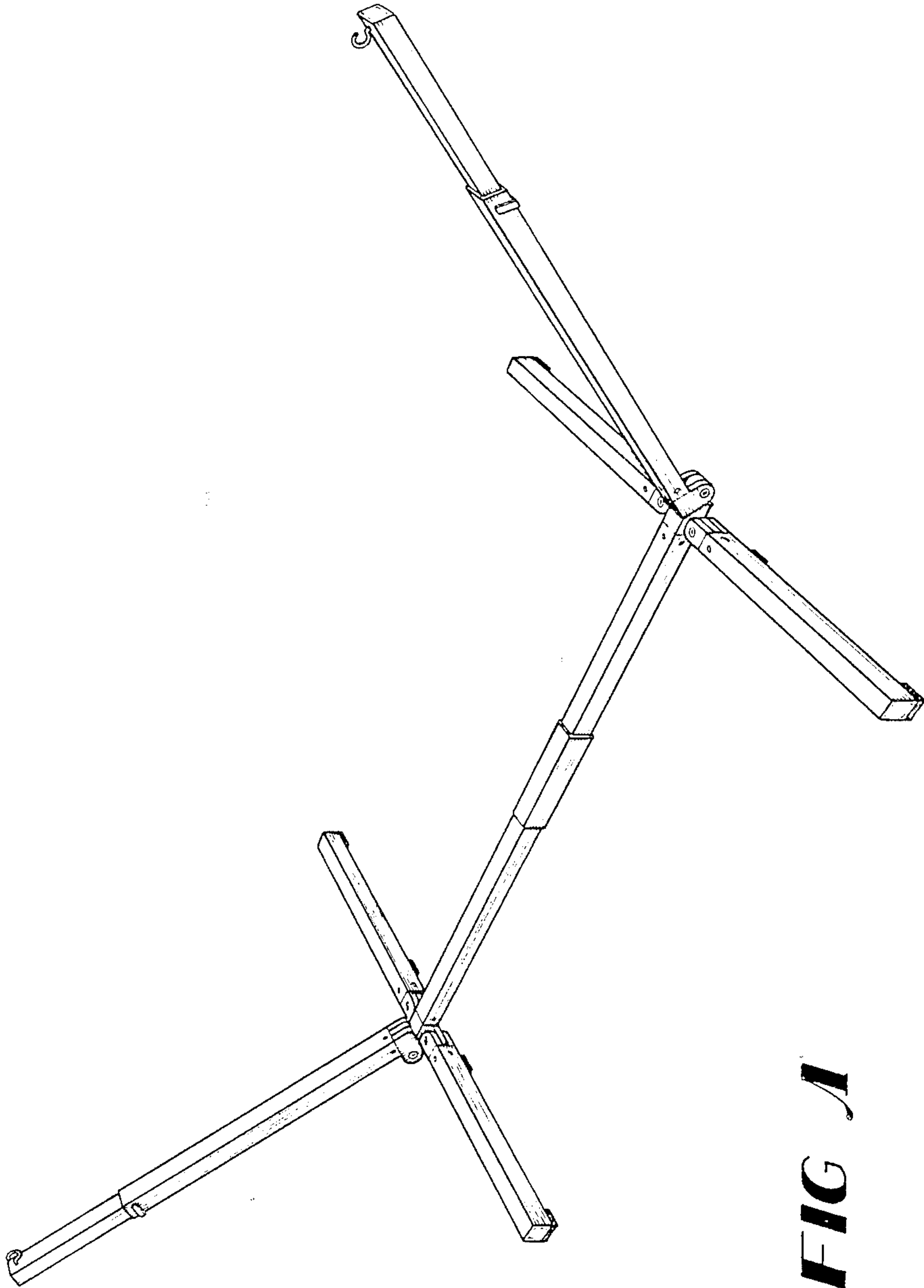

FIG 1

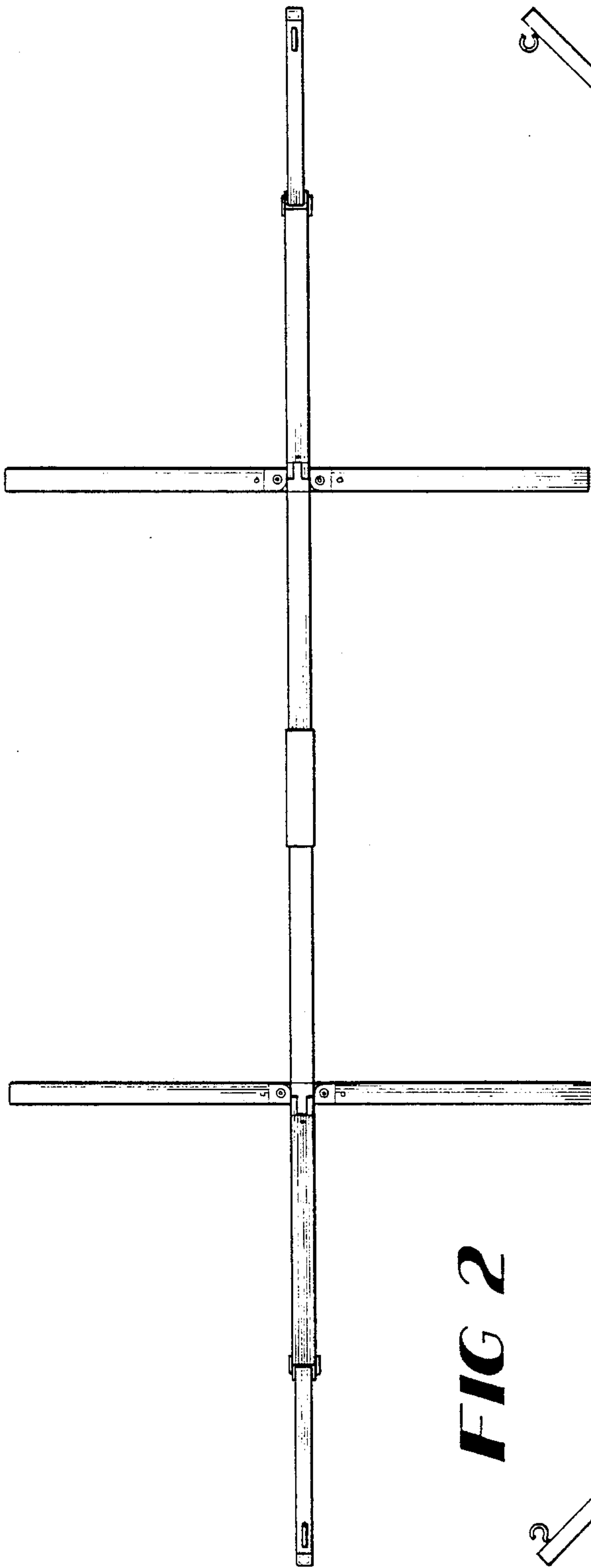

FIG 2

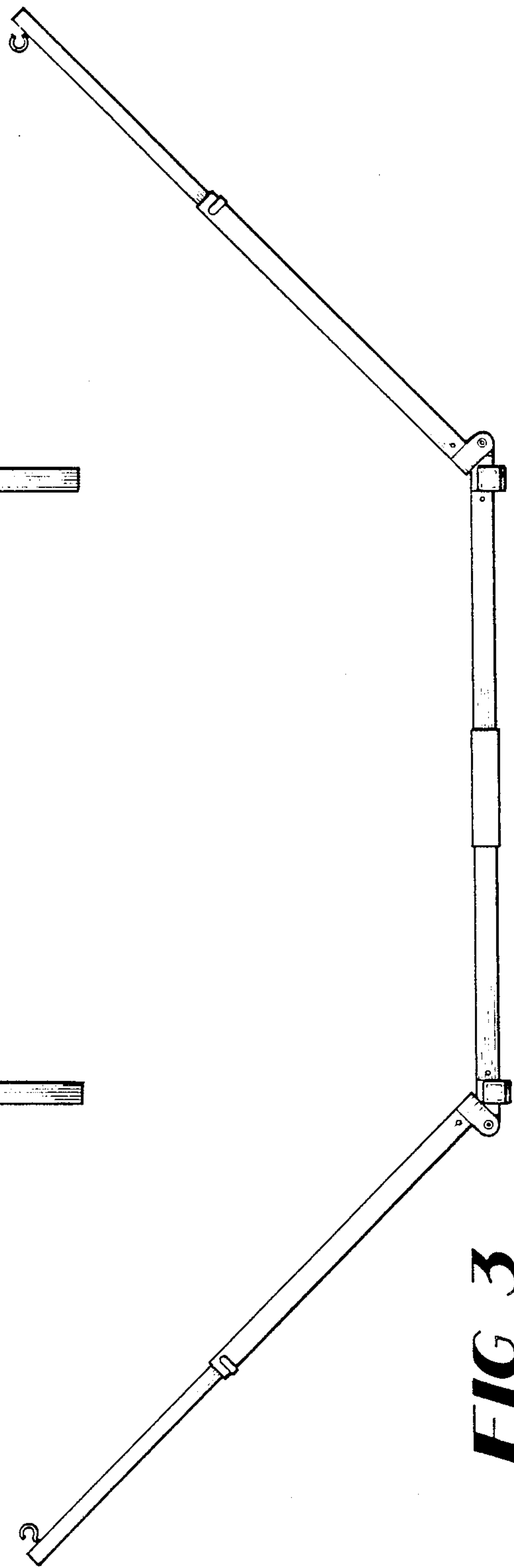

FIG 3

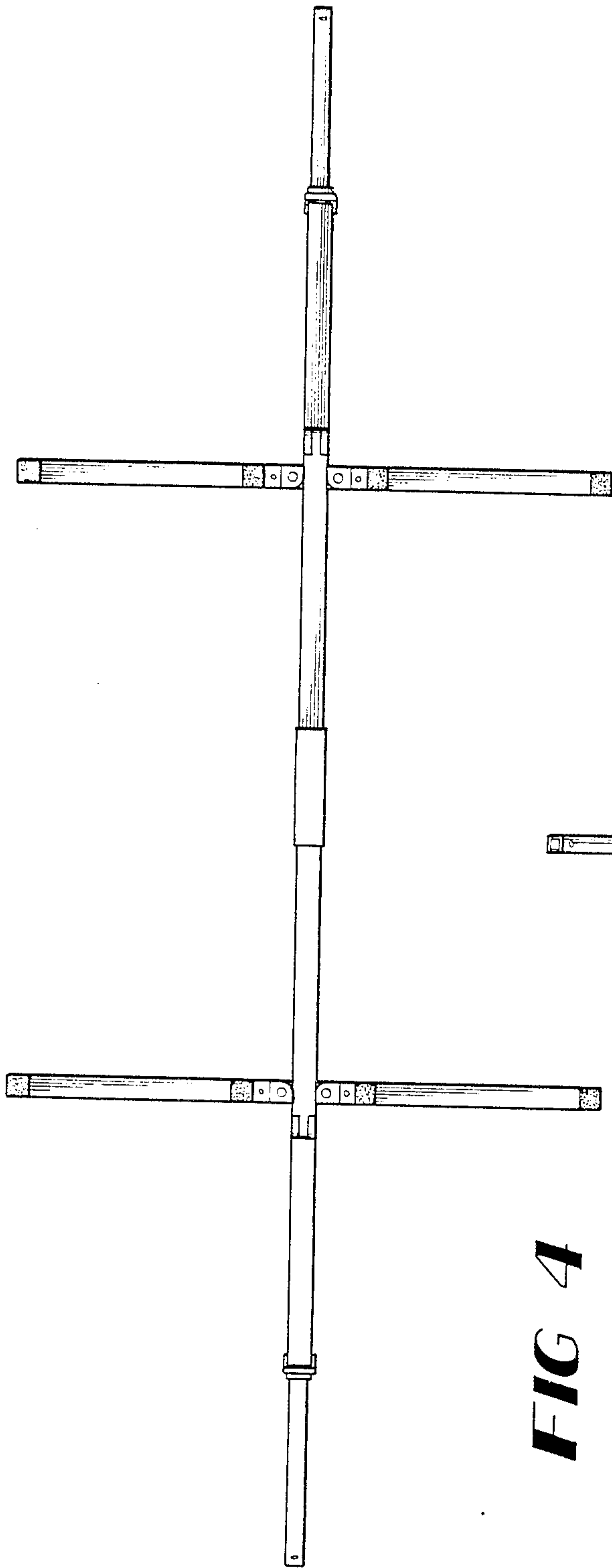

FIG 4

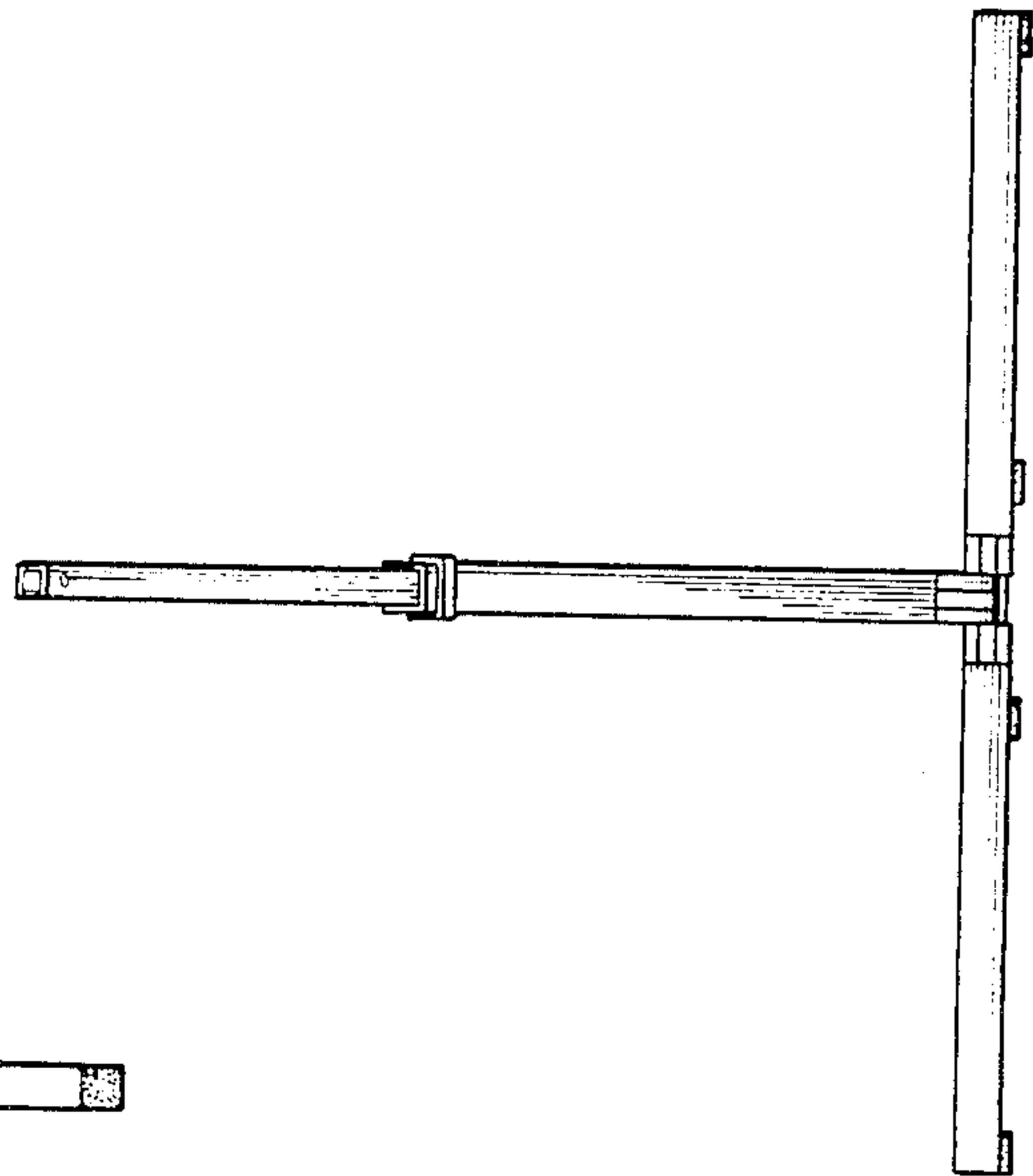

FIG 5

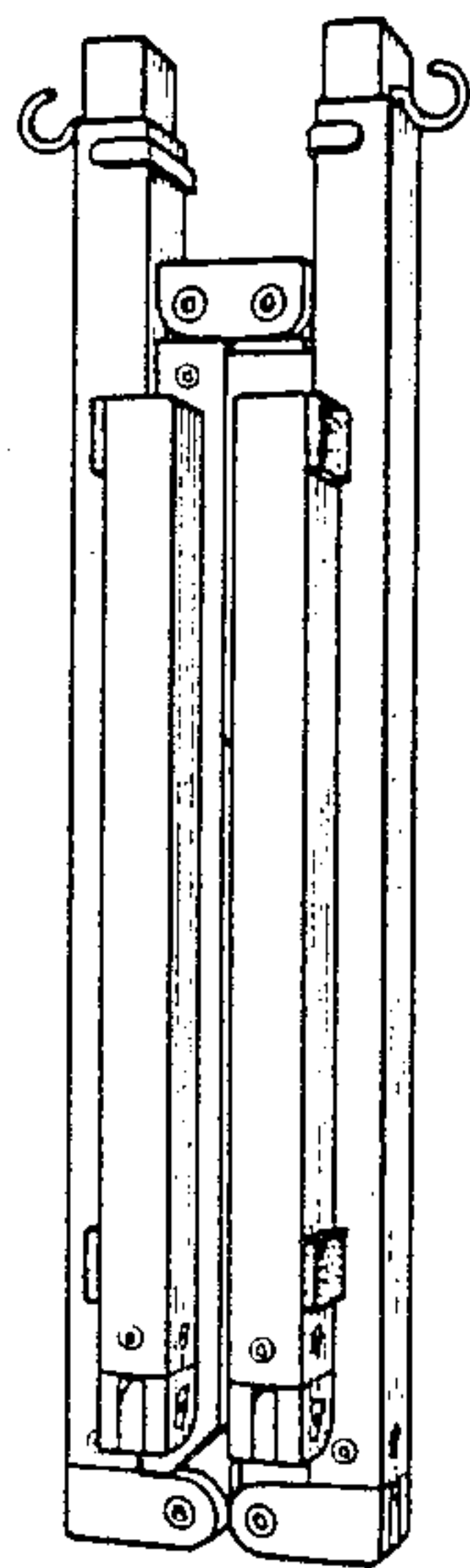

FIG 6

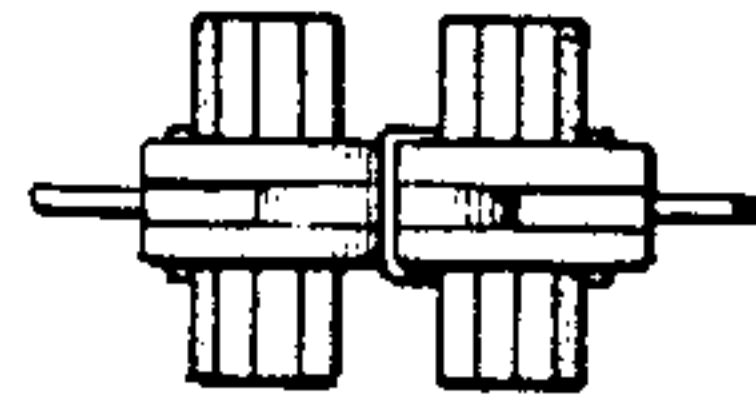

FIG 10

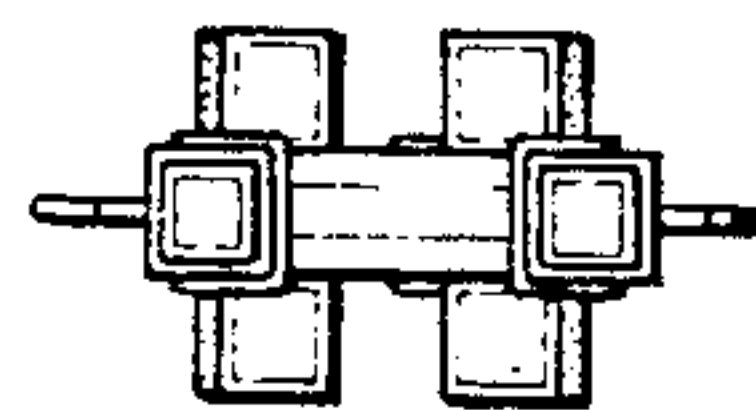

FIG 9

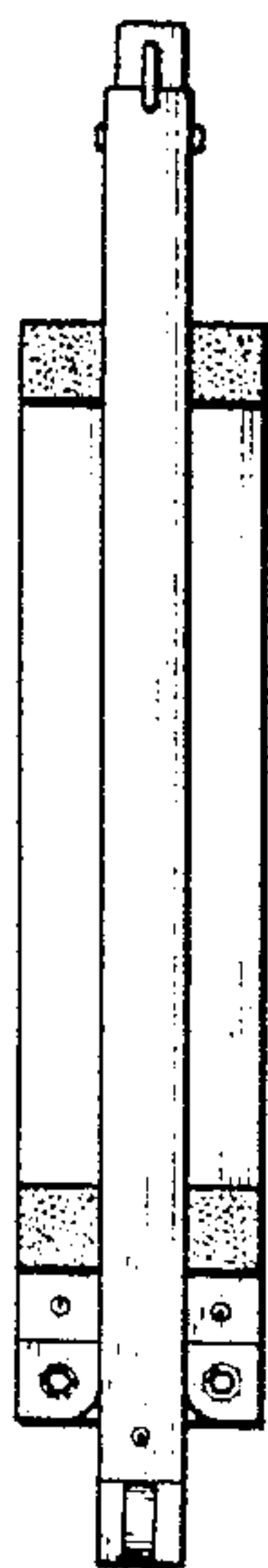

FIG 7

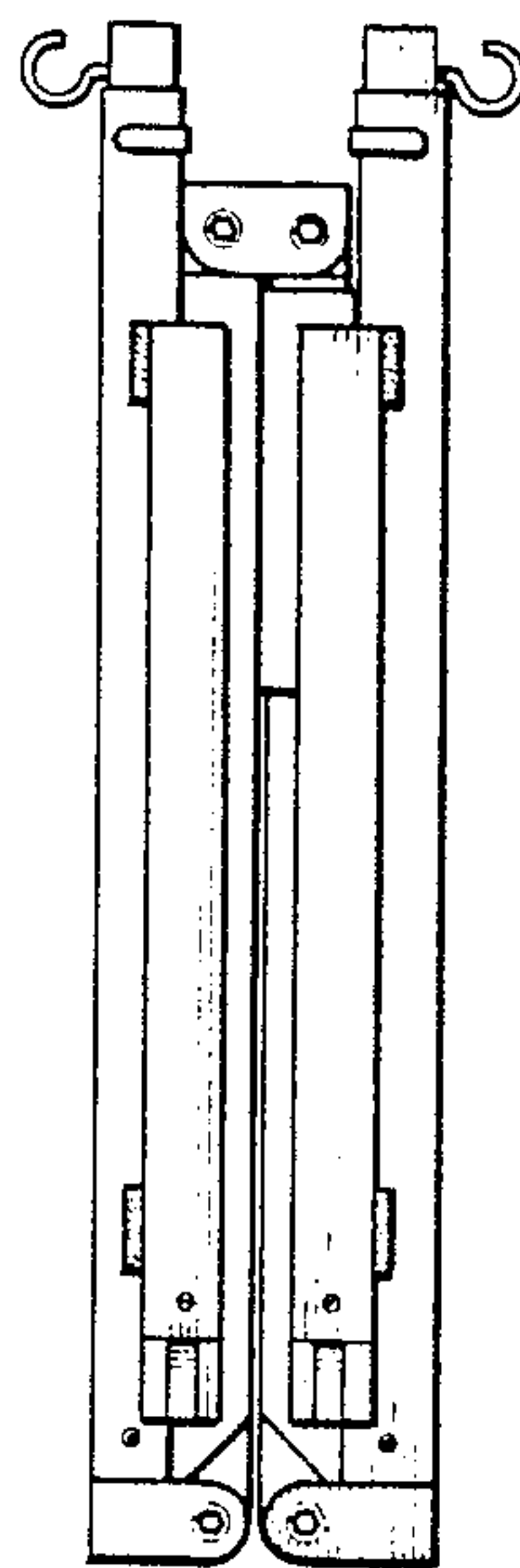

FIG 8