

[54] FRAME FOR A CHAIR
[75] Inventor: Robert F. Stubblefield, Miami, Fla.
[73] Assignee: Medallion Leisure Division Mar-Tec, Inc., Miami, Fla.
[**] Term: 14 Years
[21] Appl. No.: 784,028
[22] Filed: Oct. 4, 1985
[52] U.S. Cl. D6/373; D6/500
[58] Field of Search D6/334, 370, 372, 373, D6/375, 379, 380, 500; 297/441, 445, 447

[56] References Cited
U.S. PATENT DOCUMENTS
D. 277,908 3/1985 Liisberg D6/373
D. 287,437 12/1986 Frinier et al. D6/370 X

D. 291,157 8/1987 Martin D6/373
D. 291,391 8/1987 Arthur, Jr. D6/370
3,972,559 8/1976 Anacker 297/441 X

Primary Examiner—Bruce W. Dunkins
Attorney, Agent, or Firm—John Cyril Malloy

[57] CLAIM
The ornamental design for a frame for a chair, as shown and described.

DESCRIPTION
FIG. 1 is a front elevational view of the chair frame of the present invention.
FIG. 2 is a left side view.
FIG. 3 is a rear elevational view.
FIG. 4 is a right side view.
FIG. 5 is a top plan view.
FIG. 6 is a bottom plan view.

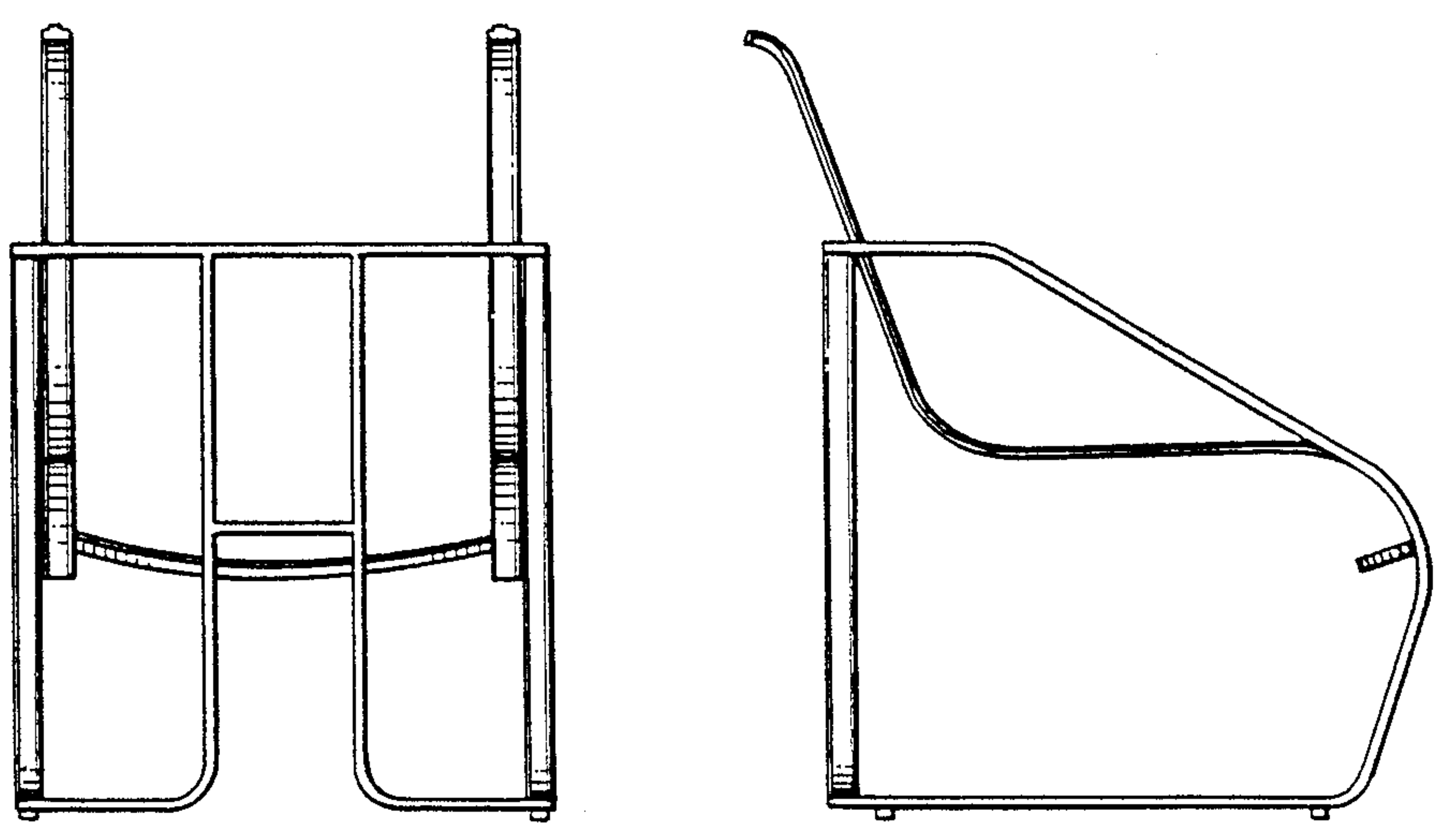

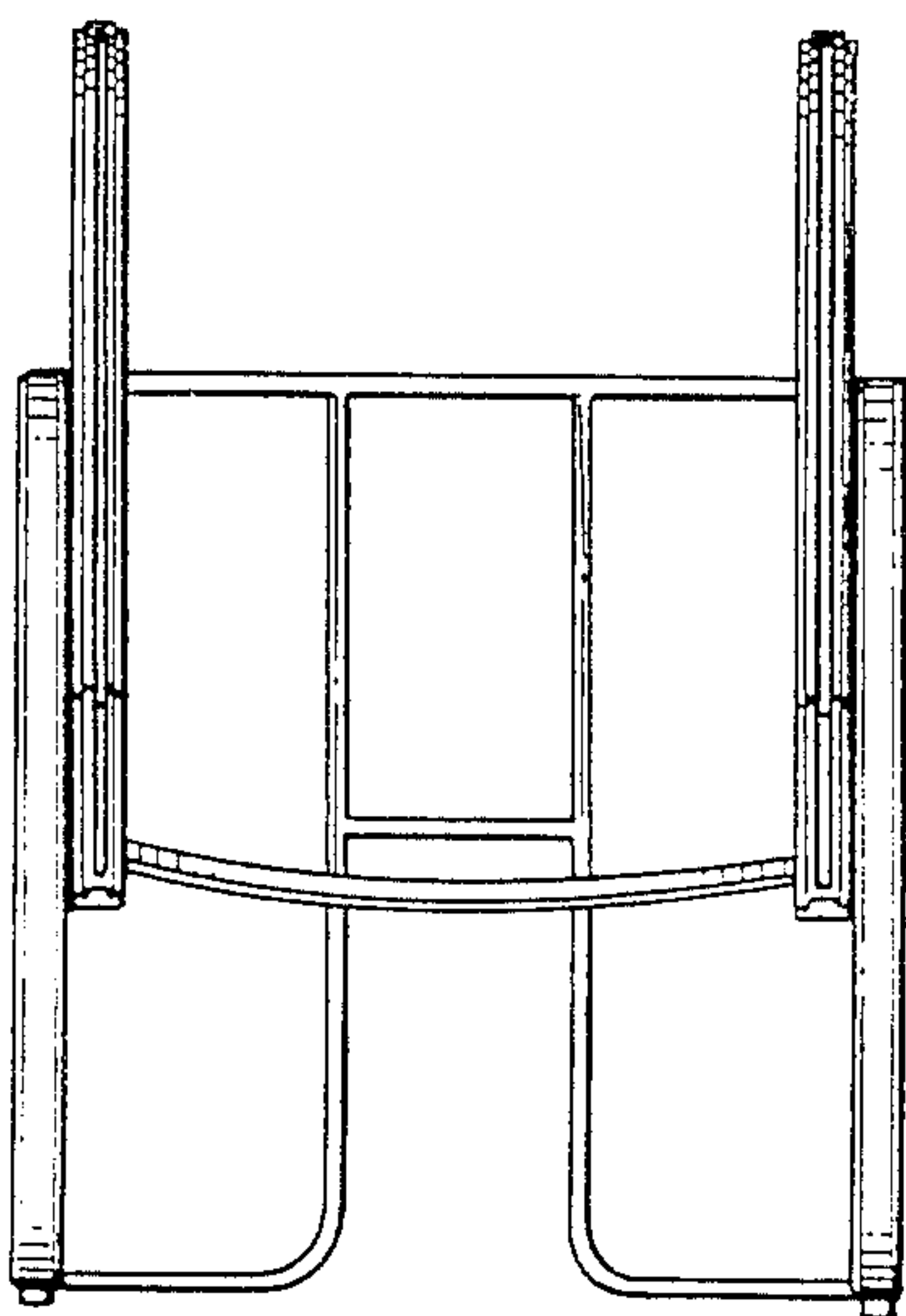

FIG. 1

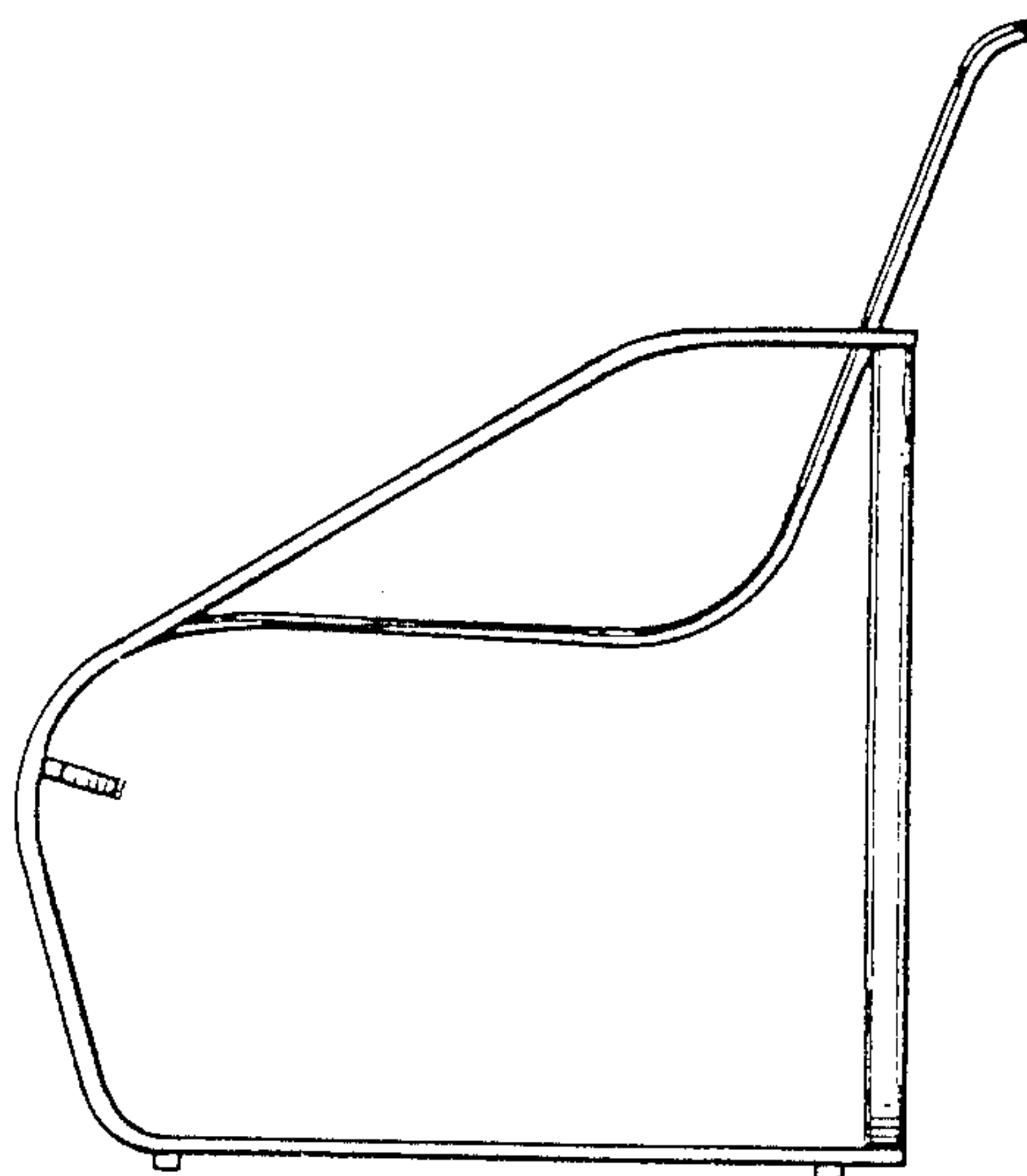

FIG. 2

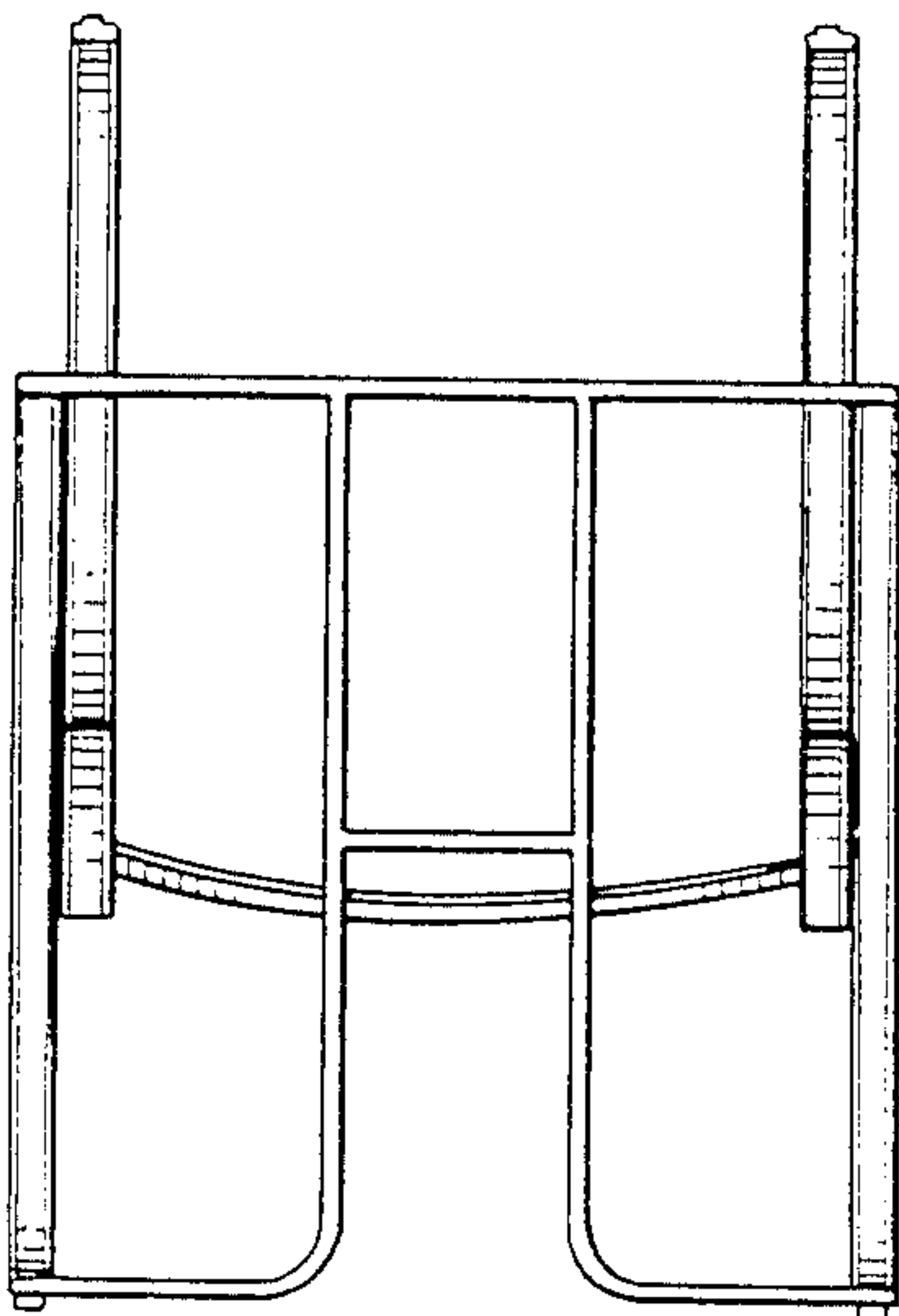

FIG. 3

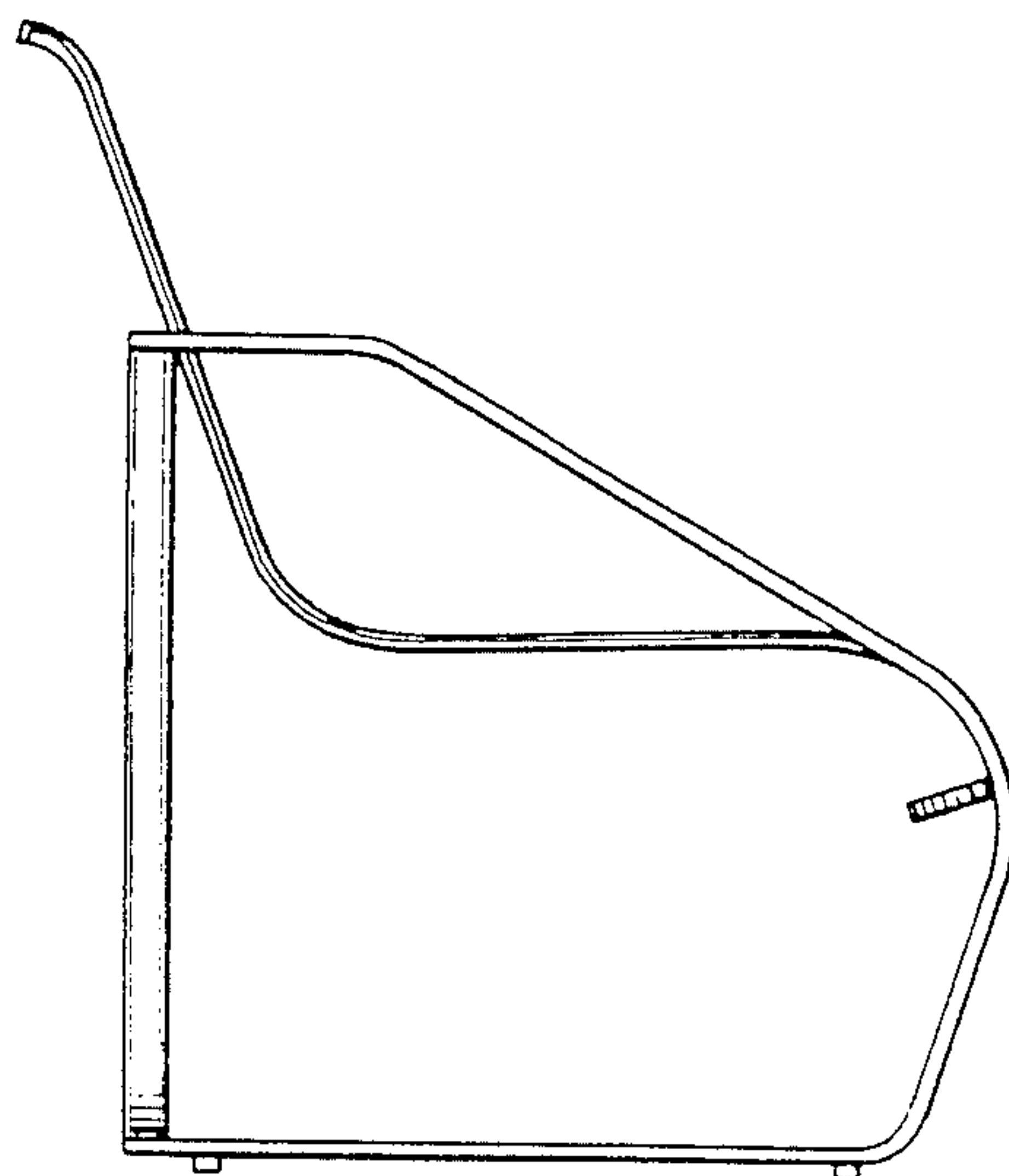

FIG. 4

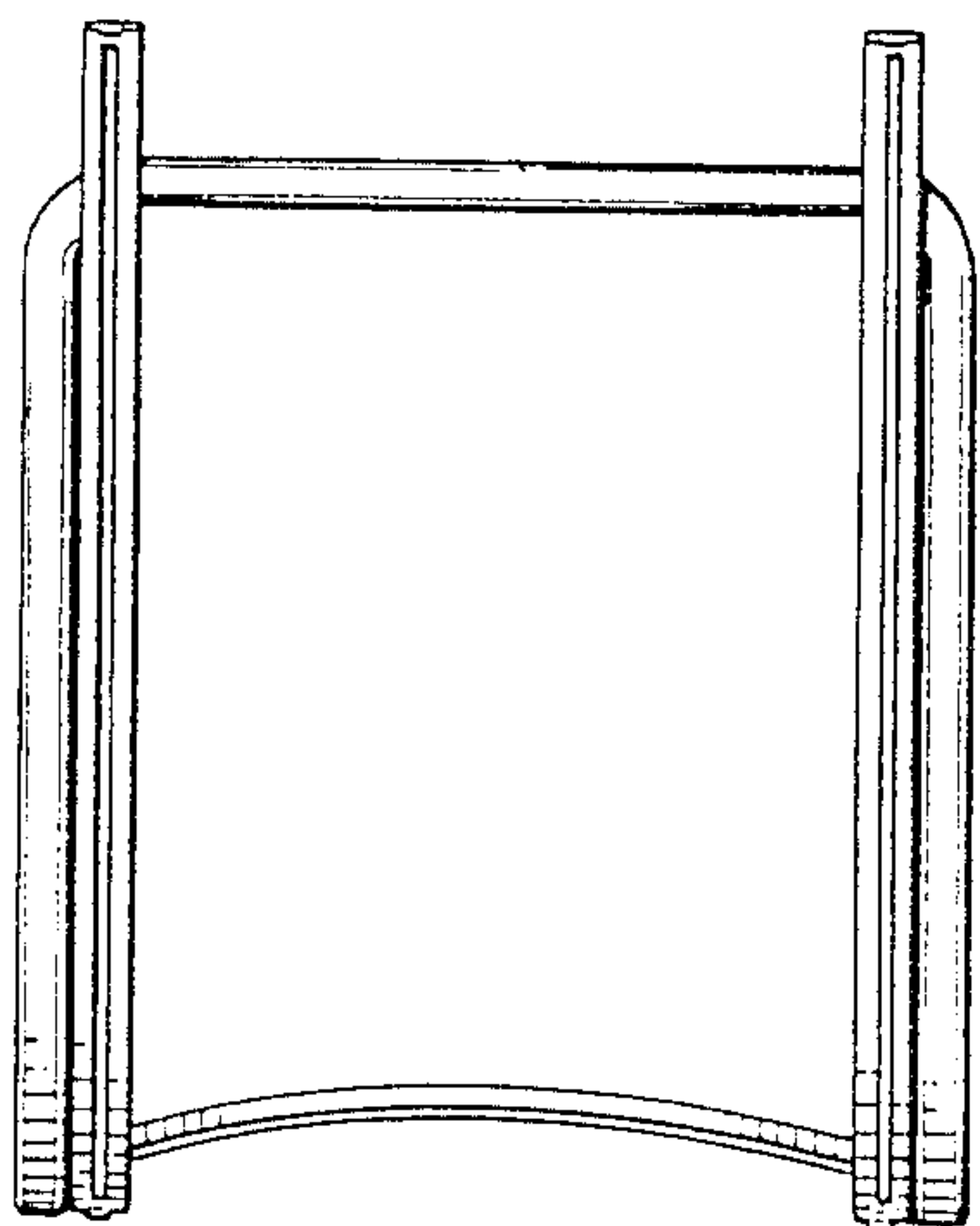

FIG. 5

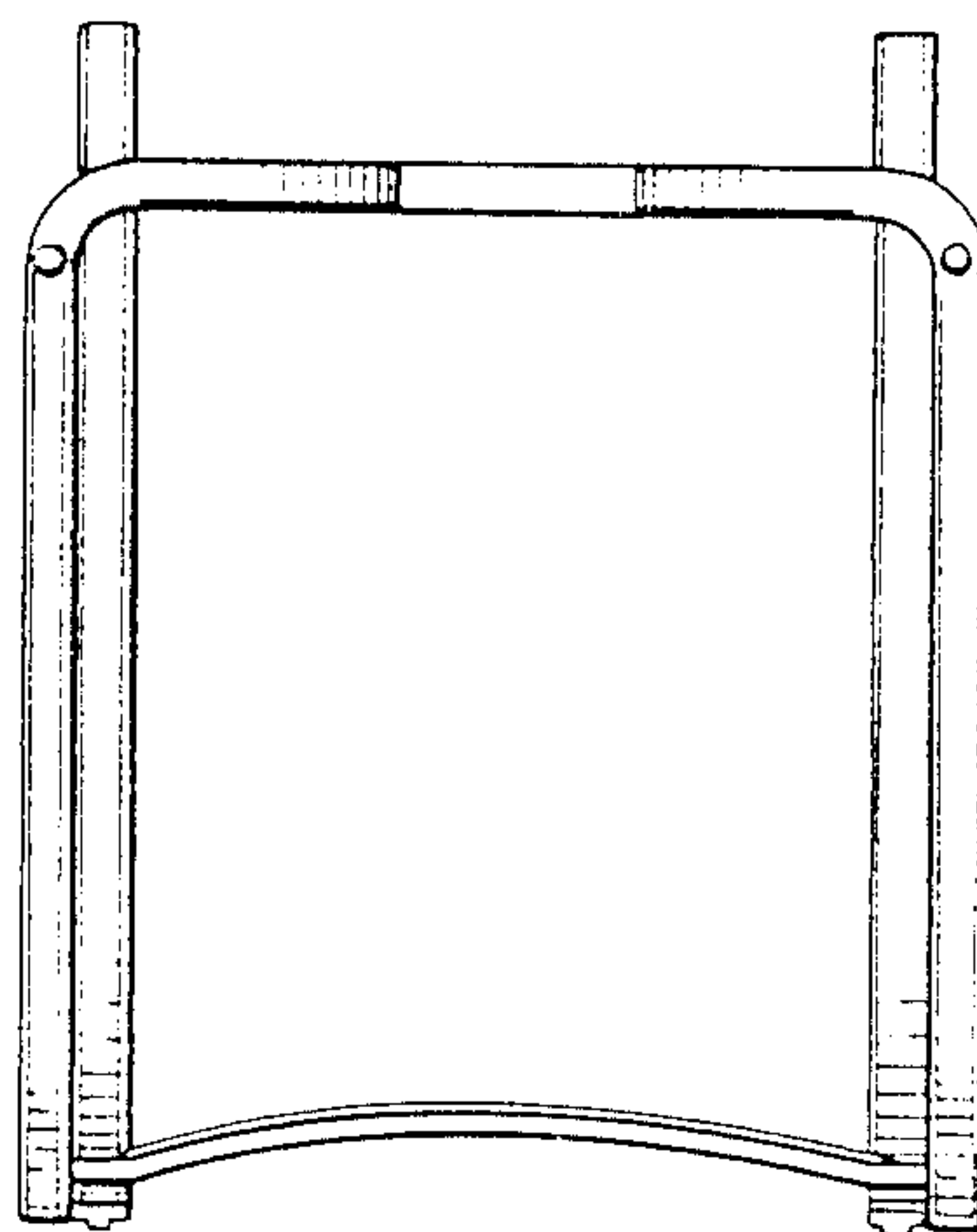

FIG. 6