

[54] ANTERIOR ARTICULATOR

[76] Inventor: Lloyd A. Kwok, 6170 Skyline Blvd.,
Burlingame, Calif. 94010

[**] Term: 14 Years

[21] Appl. No.: 806,014

[22] Filed: Nov. 21, 1985

[52] U.S. Cl. D24/10

[58] Field of Search D24/4-5,
D24/10-16; 433/53-68, 41-43, 68-71,
213-214; 264/16-20

[56] References Cited

U.S. PATENT DOCUMENTS

2,286,288	6/1942	Lover	433/68
4,022,419	5/1977	Haker	433/37 X
4,299,570	11/1981	Yogosawa	433/64 X
4,439,151	3/1984	Whelan	433/60
4,538,987	9/1985	Weissman	433/60

Primary Examiner—B. J. Bullock
Assistant Examiner—Brian N. Vinson

Attorney, Agent, or Firm—Thomas M. Freiburger

[57] CLAIM

The ornamental design for an anterior articulator, substantially as shown and described.

DESCRIPTION

FIG. 1 is a top plan view of an anterior articulator showing my new design in an open position;
FIG. 2 is a bottom plan view of the lower portion thereof;
FIG. 3 is a right side elevational view of the lower portion thereof, the left side being a mirror image;
FIG. 4 is a front elevational view of the lower portion thereof;
FIG. 5 is a rear elevational view of the lower portion thereof;
FIG. 6 is a top, front perspective view of the lower portion thereof; and
FIG. 7 is a bottom, front fragmentary perspective view of the upper portion thereof, the area shown broken-away being identical in appearance to the lower portion.

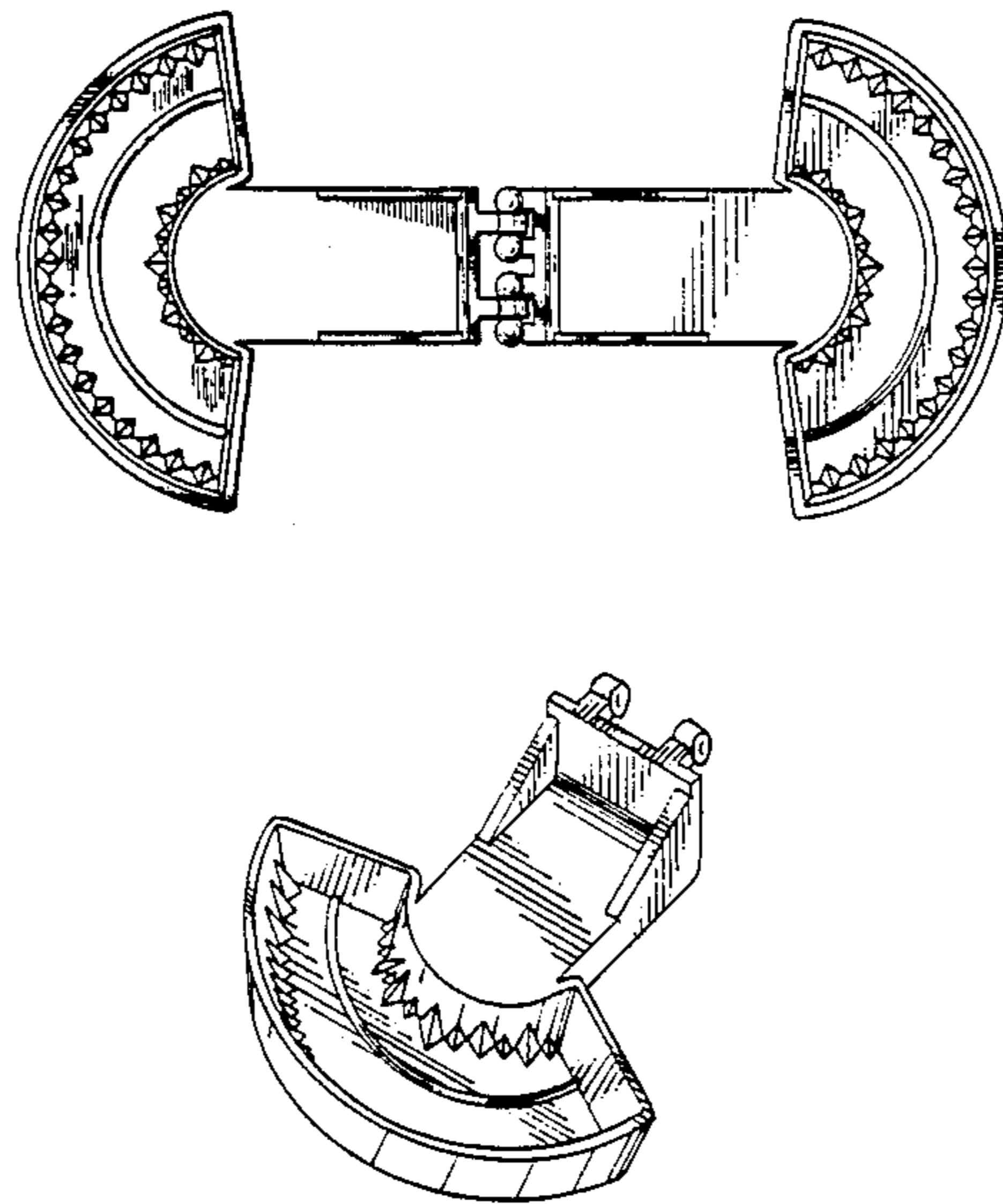

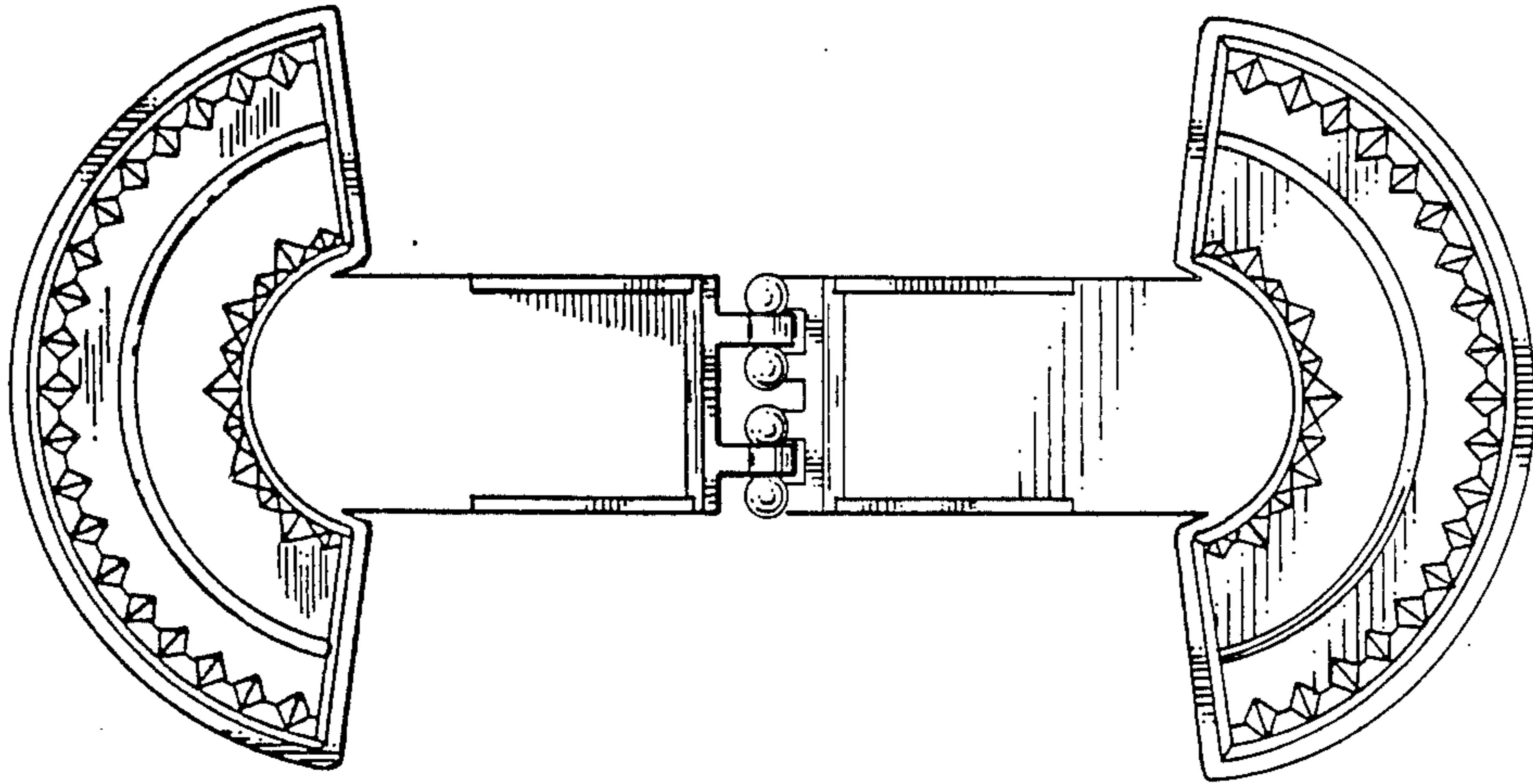

FIG _ 1

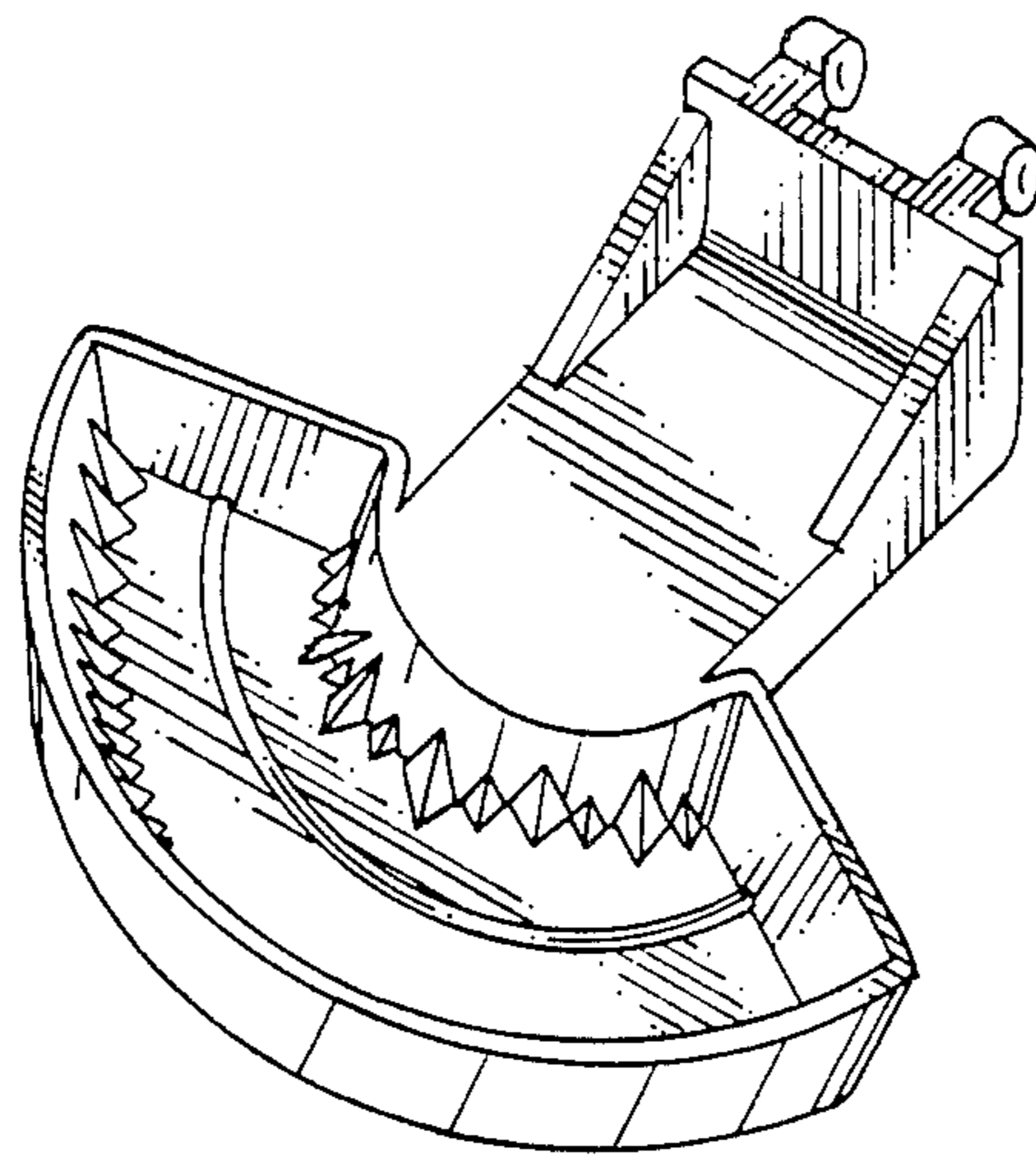
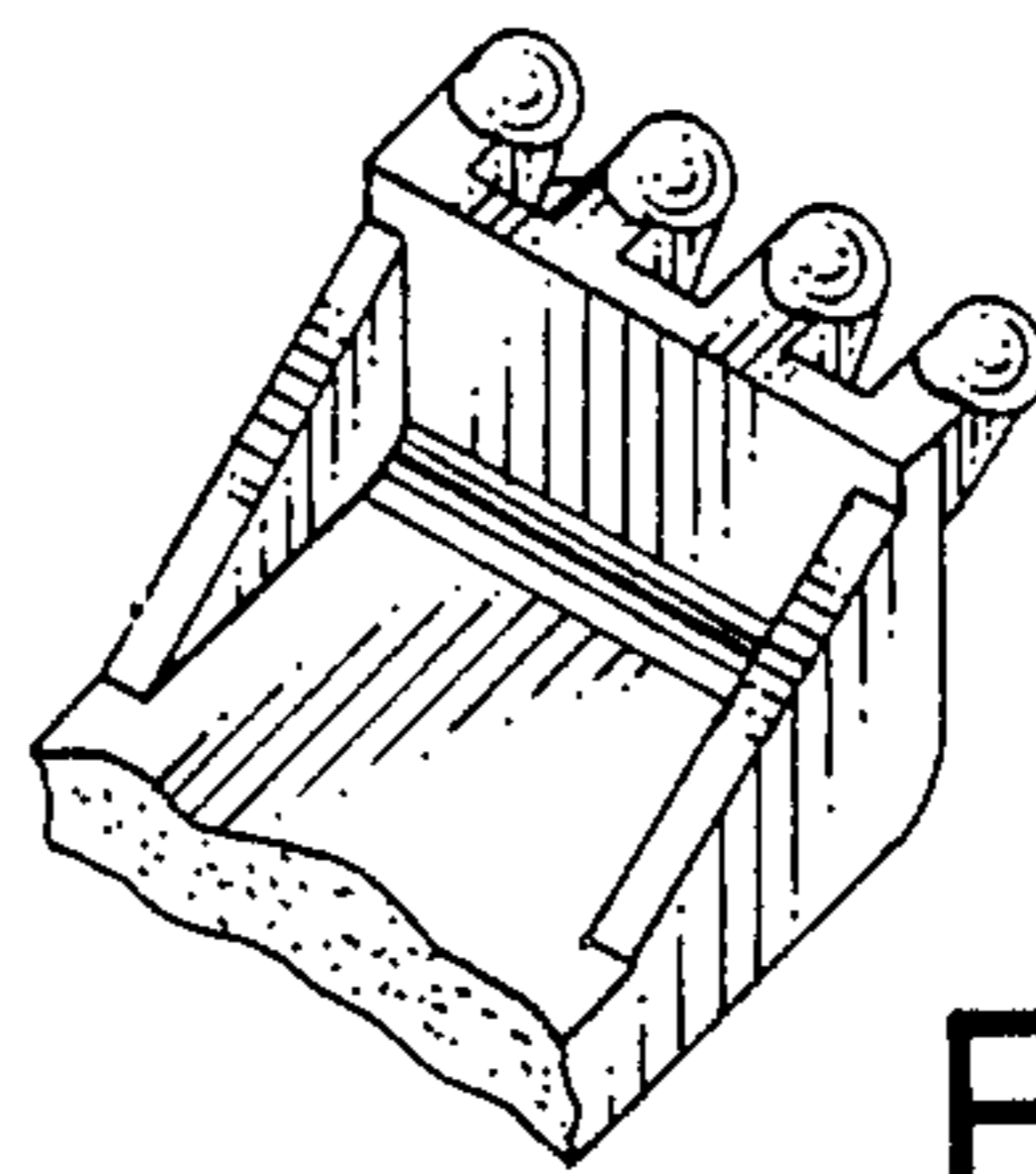

FIG _ 6



FIG_7

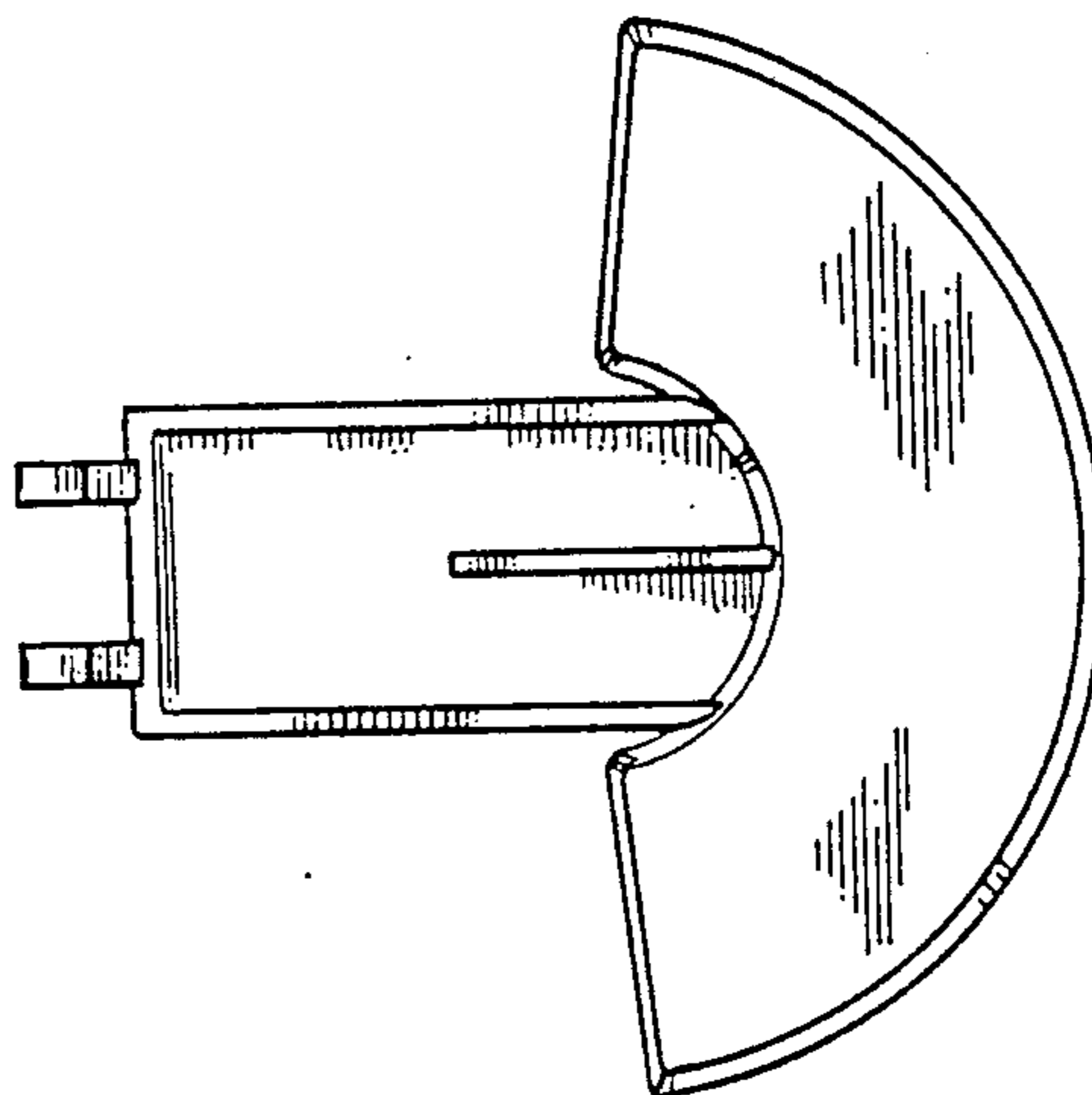

FIG _ 2

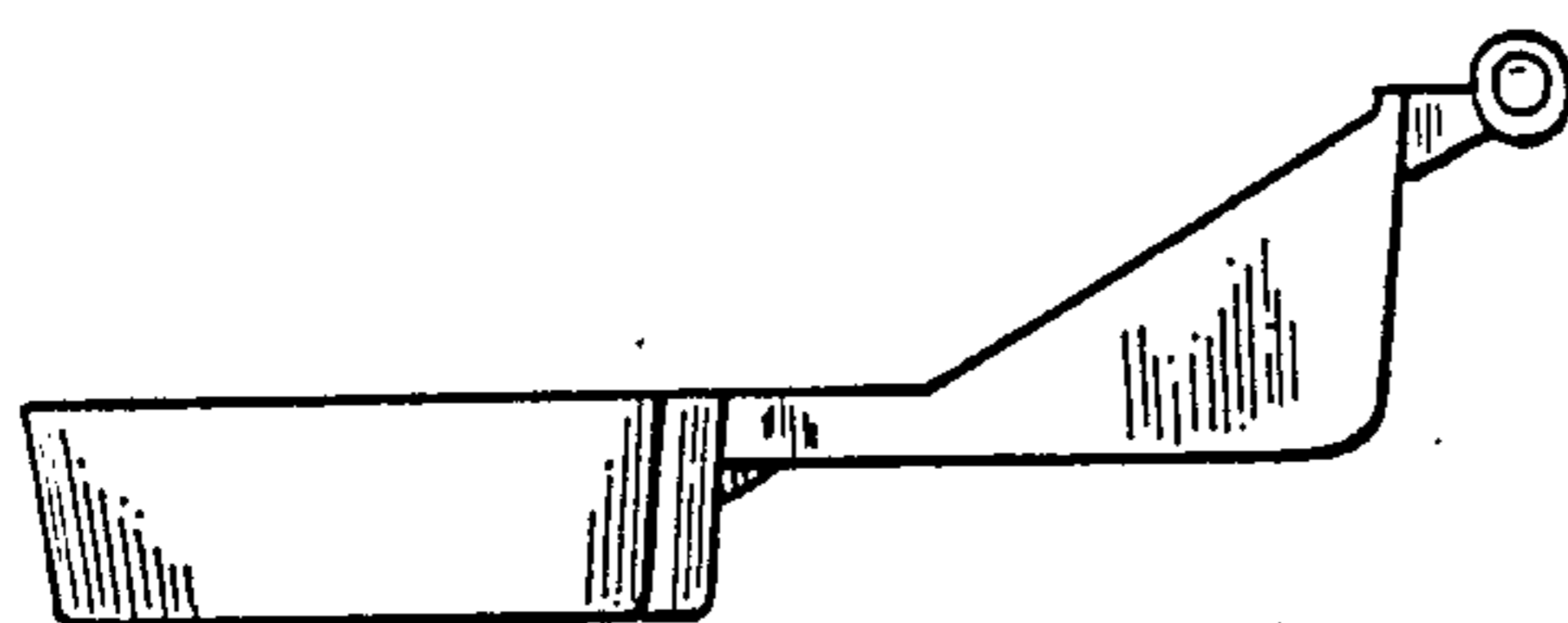

FIG _ 3

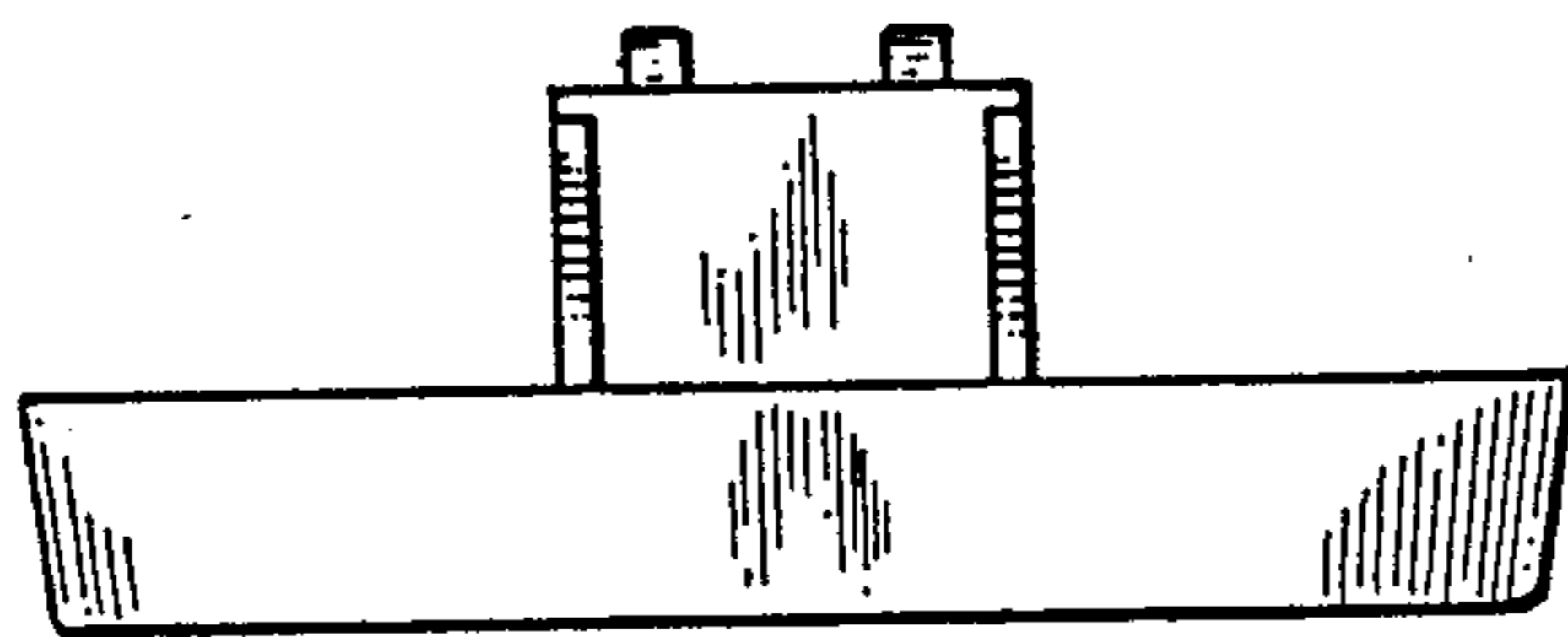

FIG _ 4

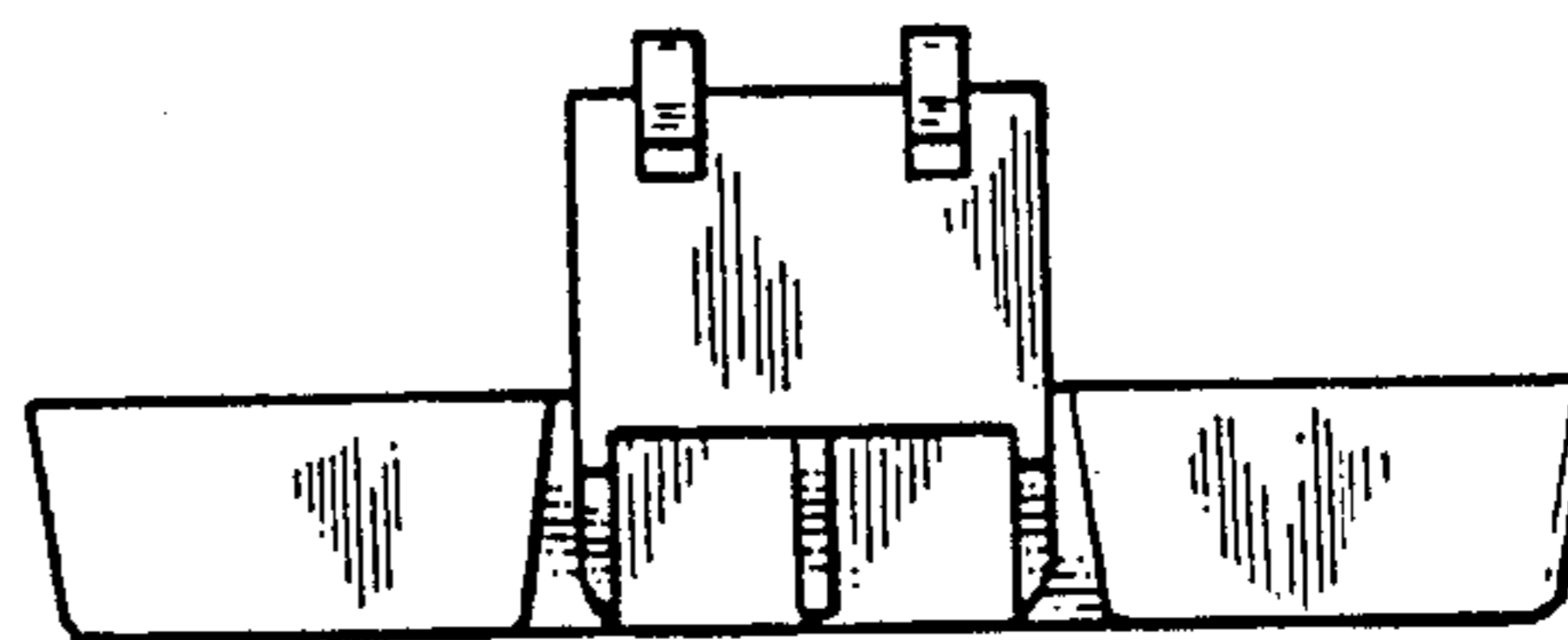

FIG _ 5