

[54] SORTER FOR A COPIER

[75] Inventor: Minoru Aoyama, Tokyo, Japan

[73] Assignee: Canon Kabushiki Kaisha, Tokyo, Japan

[**] Term: 14 Years

[21] Appl. No.: 766,407

[22] Filed: Aug. 16, 1985

[30] Foreign Application Priority Data

Feb. 22, 1985 [JP] Japan 60-6921

[52] U.S. Cl. D16/32; D14/110

[58] Field of Search D16/32, 27-31; D14/110; 271/283-293

[56] References Cited

U.S. PATENT DOCUMENTS

- D. 236,854 9/1975 Lucker D14/110
- D. 245,166 7/1977 Bevilacqua D16/32
- D. 248,400 7/1978 Alderson D16/32

- D. 261,653 11/1981 Lawrence D16/32 X
- D. 266,523 10/1982 Yasutani D16/32

OTHER PUBLICATIONS

The Office-7/85, p. 76-Np7550 Copier at bottom-left with Dual Collator.

Primary Examiner—Nelson C. Holtje
Attorney, Agent, or Firm—Fitzpatrick, Cella, Harper & Scinto

[57] CLAIM

The ornamental design for a sorter for a copier, as shown and described.

DESCRIPTION

- FIG. 1 is a front elevational view of a sorter for a copier showing my new design;
- FIG. 2 is a rear elevational view thereof;
- FIG. 3 is a top plan view thereof;
- FIG. 4 is a bottom plan view thereof;
- FIG. 5 is a left side elevational view thereof;
- FIG. 6 is a right side elevational view thereof;
- FIG. 7 is a top and right front perspective view thereof.

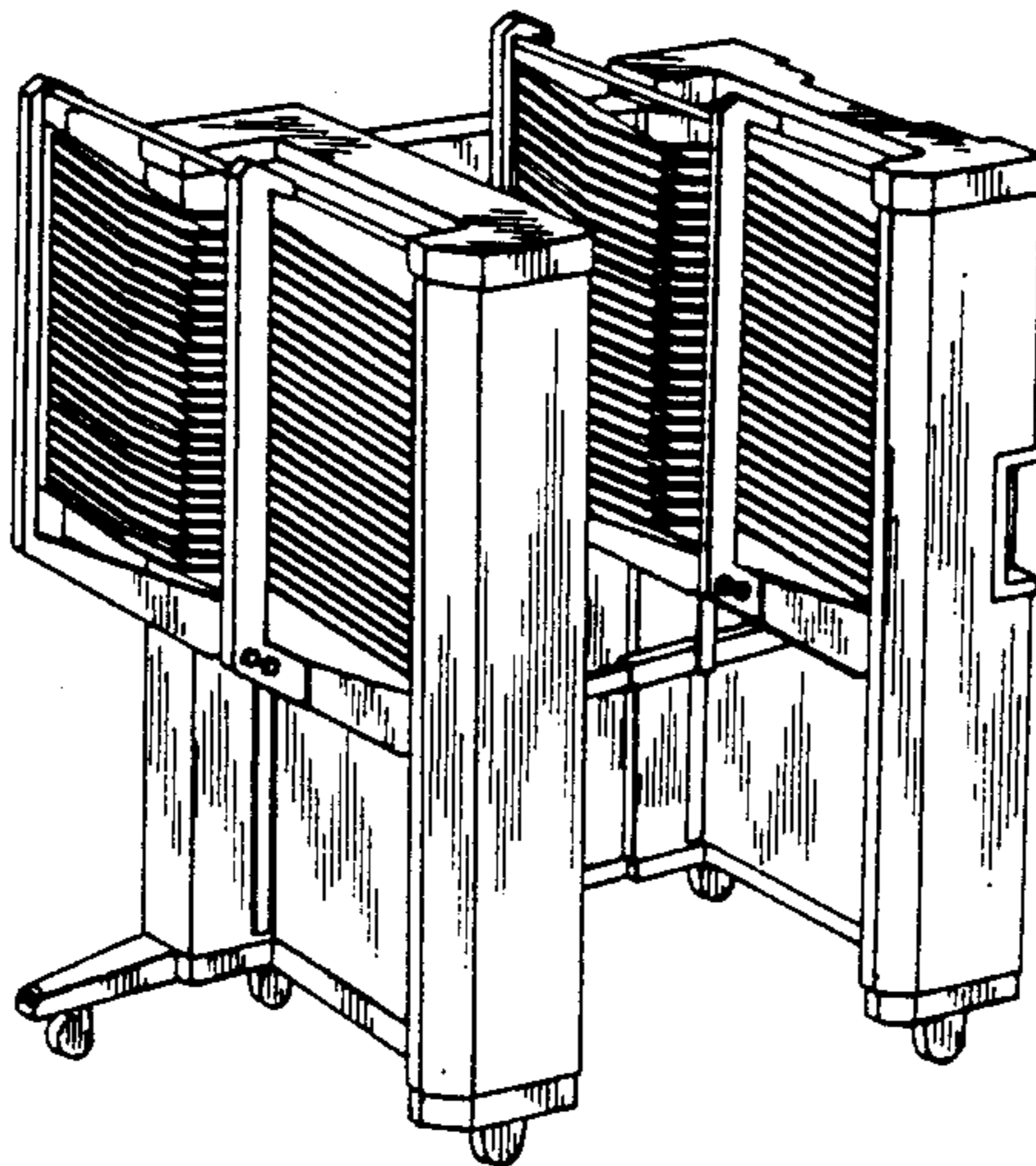

FIG. 1

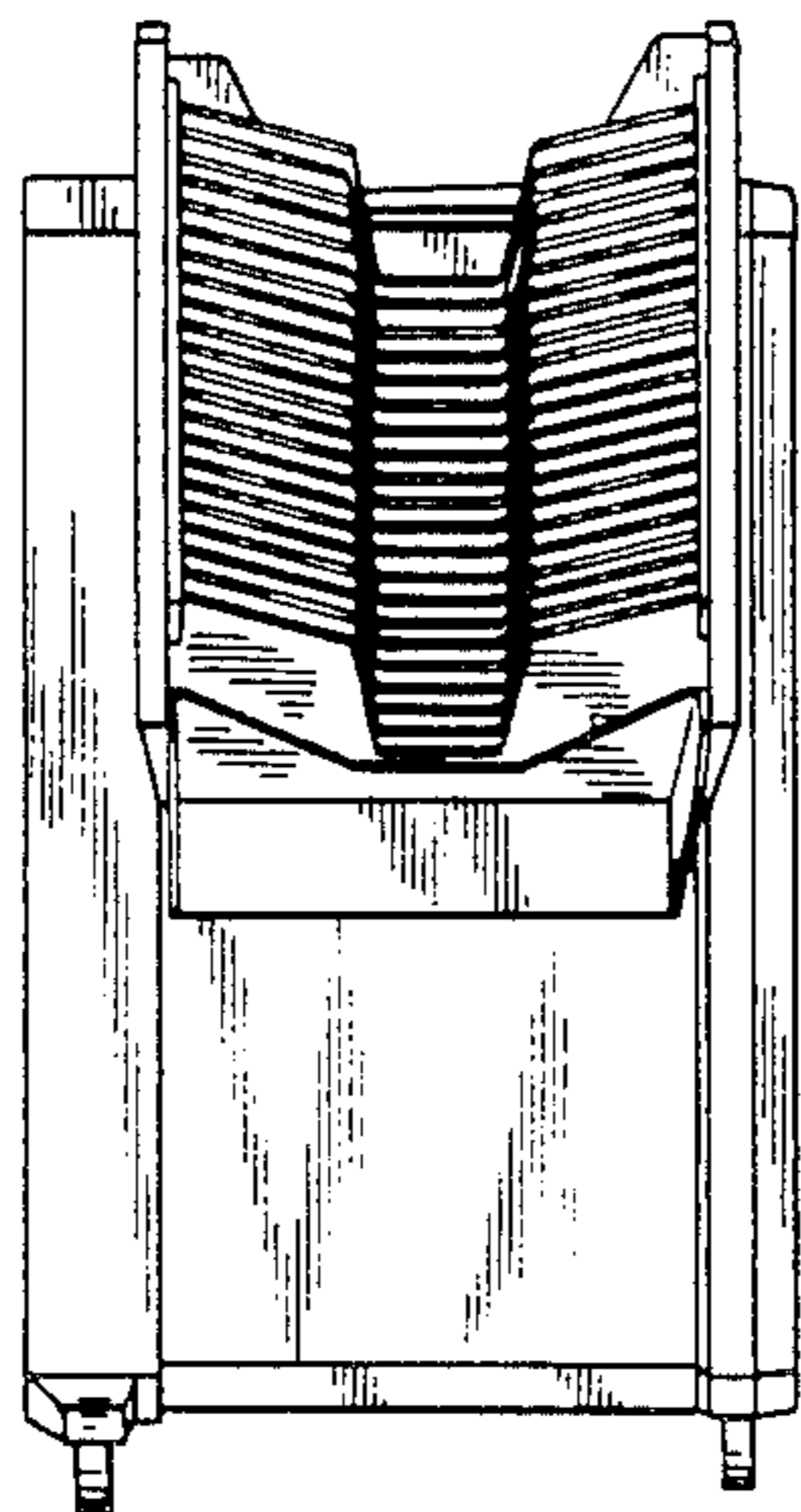

FIG. 2

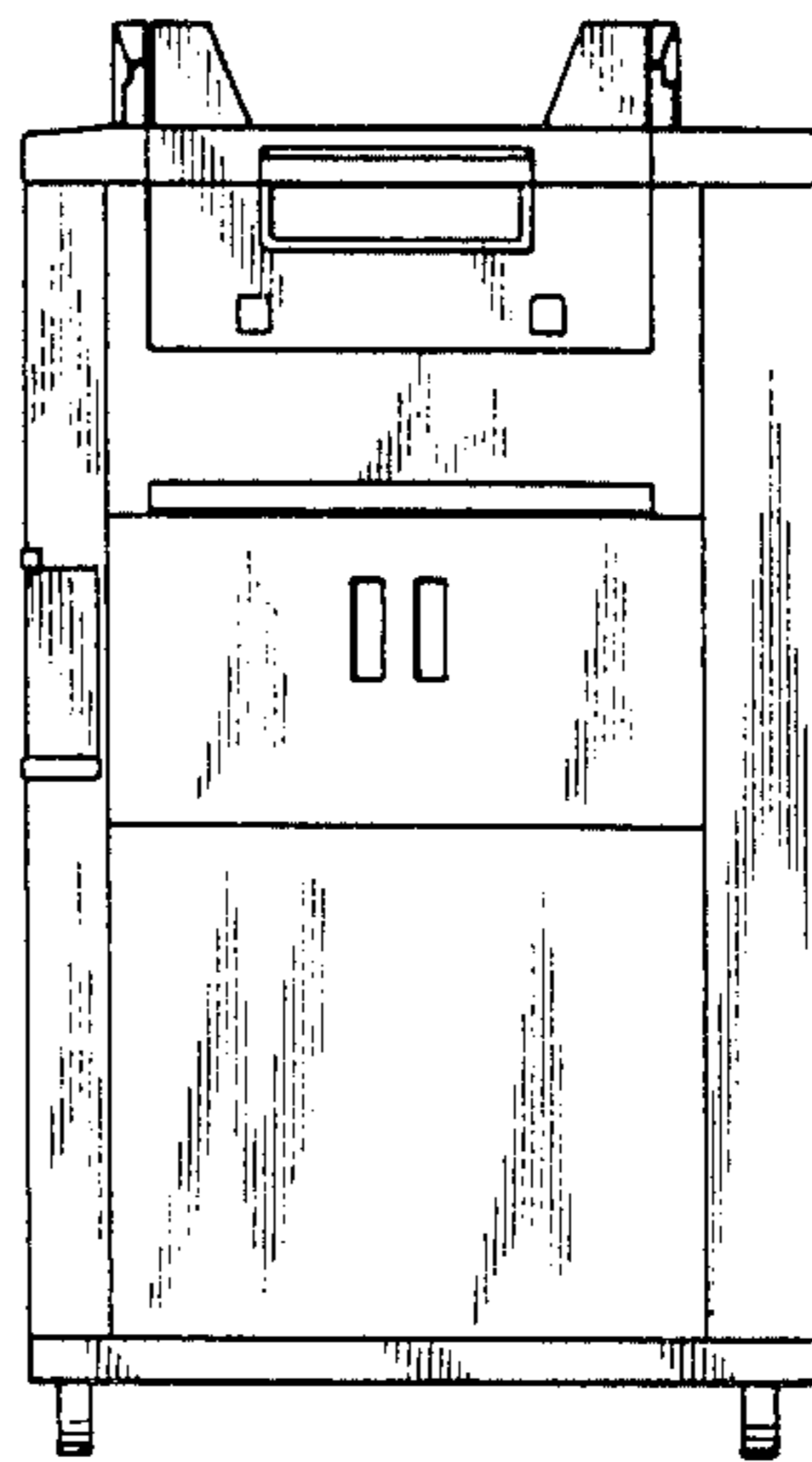

FIG. 3

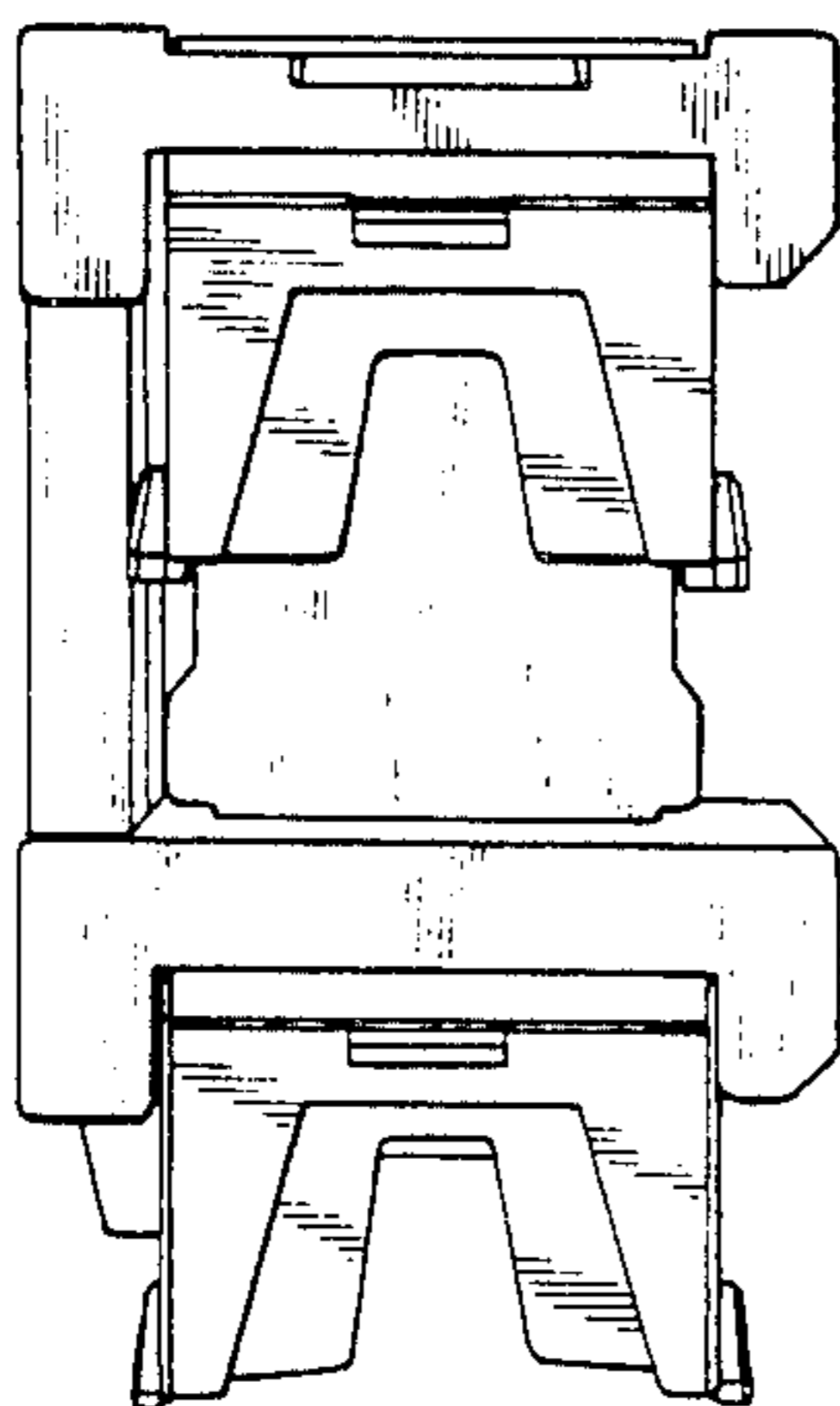

FIG. 4

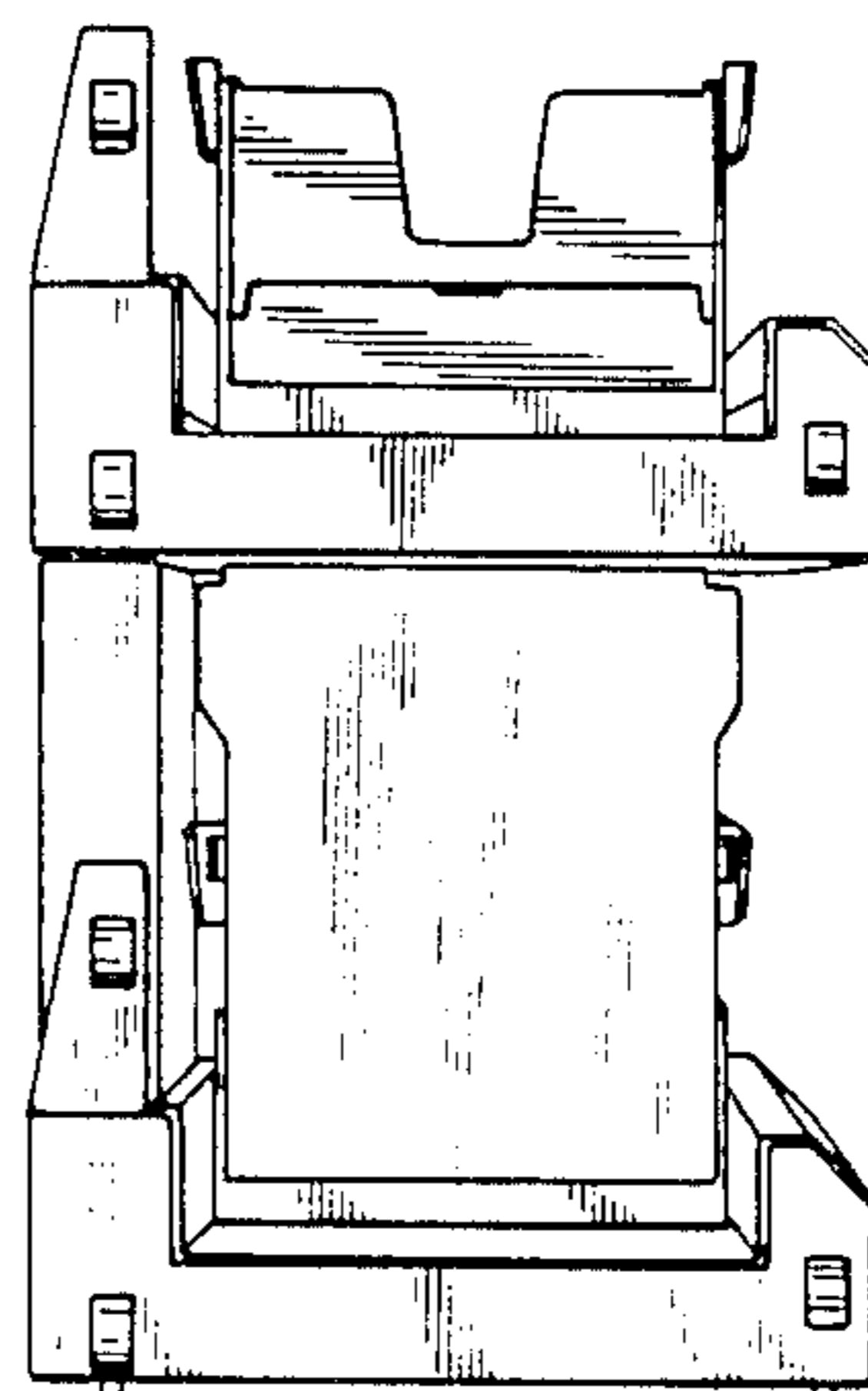

FIG. 5

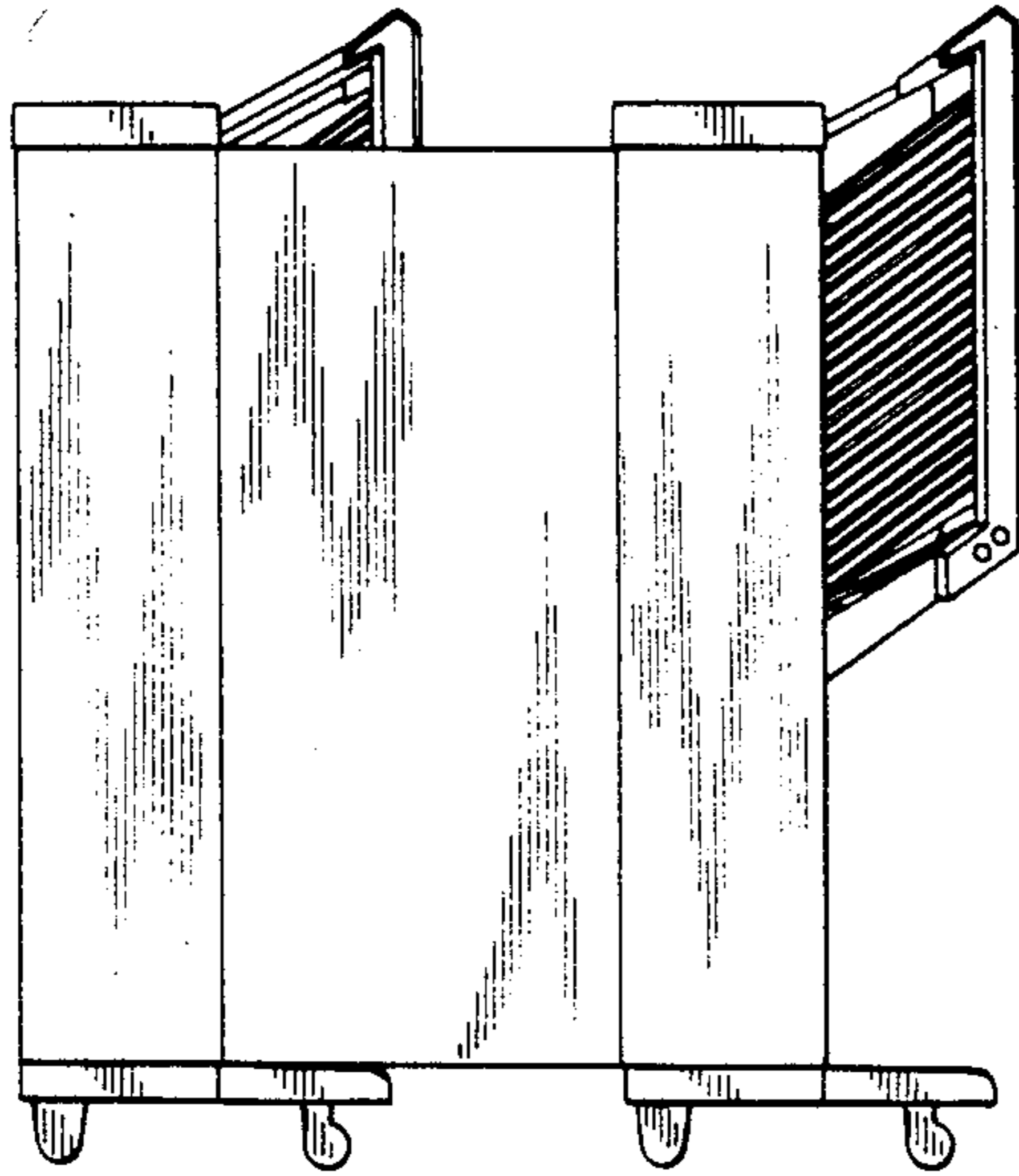

FIG. 6

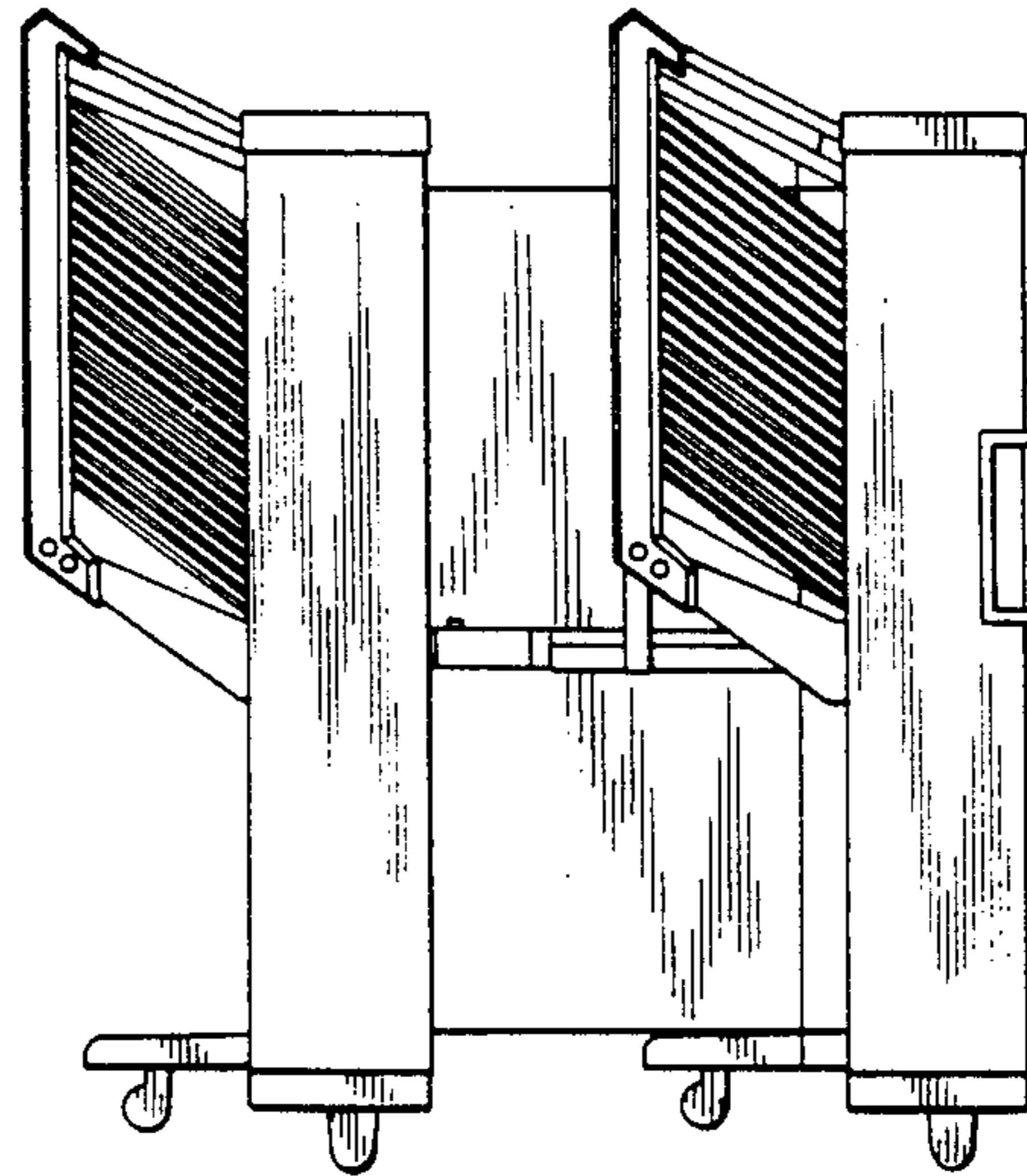

FIG. 7

