

[54] STORAGE AND CARRYING BASE FOR A PORTABLE ELECTRIC DRILL

[75] Inventor: Alain Verdier, Ste Foy les Lyon, France

[73] Assignee: Black & Decker Inc., Newark, Del.

[\*\*] Term: 14 Years

[21] Appl. No.: 770,760

[22] Filed: Aug. 29, 1985

[30] Foreign Application Priority Data

Mar. 1, 1985 [FR] France ..... 85.0924

[52] U.S. Cl. .... D3/73; D3/30.1; D3/74

[58] Field of Search ..... D3/30.1, 35, 73, 74; D8/34-37; D6/553, 556; 206/349-379

[56] References Cited

U.S. PATENT DOCUMENTS

- D. 201,781 7/1965 Cuccio et al. .... D3/73
- D. 245,880 9/1977 Malcolm ..... D3/73
- D. 291,747 9/1987 Bunge ..... D3/73

Primary Examiner—George P. Word  
Attorney, Agent, or Firm—Edward D. Murphy; Harold Weinstein; Edward D. C. Bartlett

[57] CLAIM

The ornamental design for a storage and carrying base for a portable electric drill, as shown.

DESCRIPTION

FIG. 1 is a front elevational view of a storage and carrying base for a portable electric drill, showing my new design;  
 FIG. 2 is a rear elevational view thereof;  
 FIG. 3 is a left side elevational thereof;  
 FIG. 4 is a right side elevational view thereof;  
 FIG. 5 is a top plan view thereof;  
 FIG. 6 is a bottom plan view thereof; and,  
 FIG. 7 is a perspective view thereof.

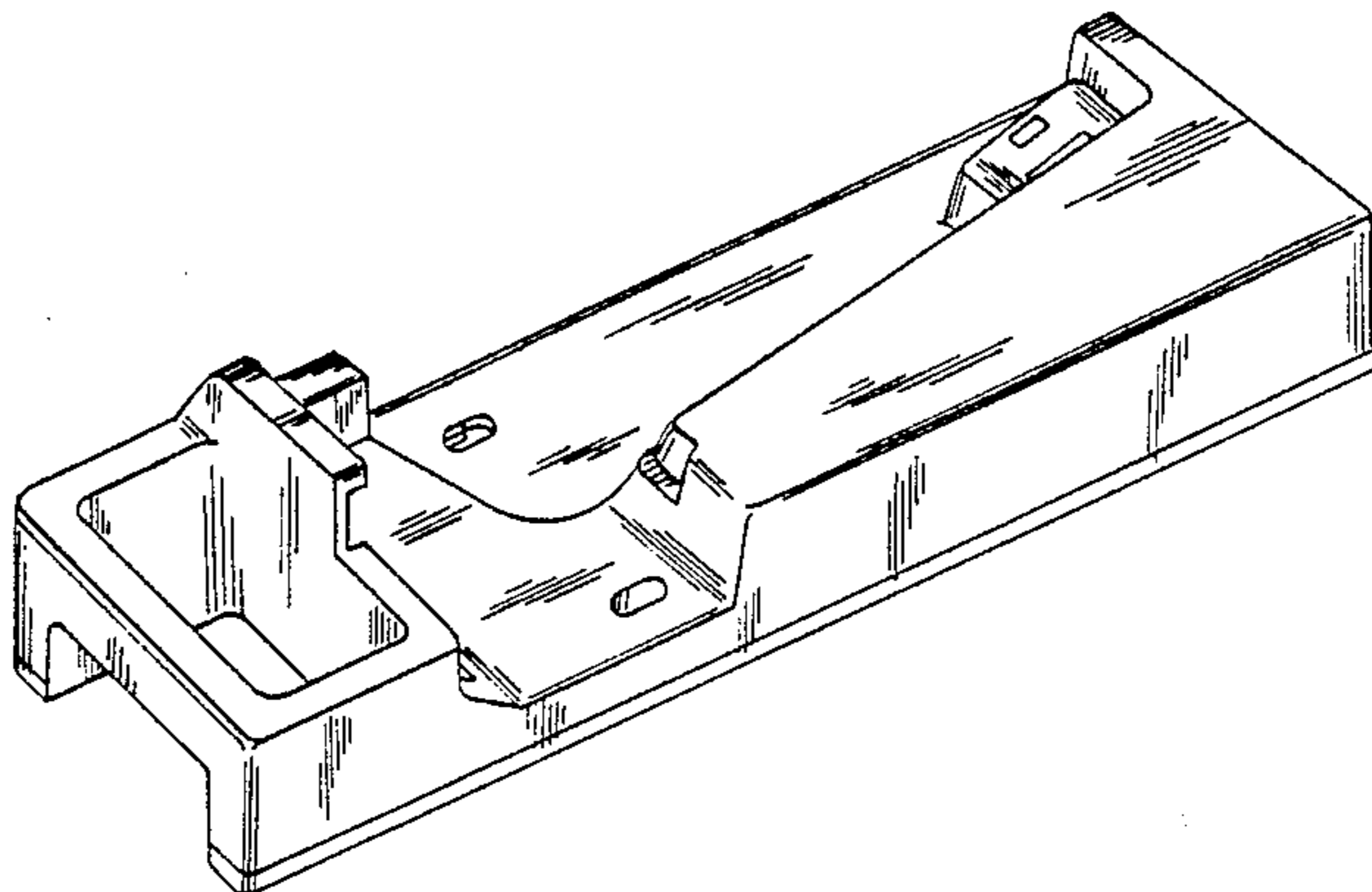

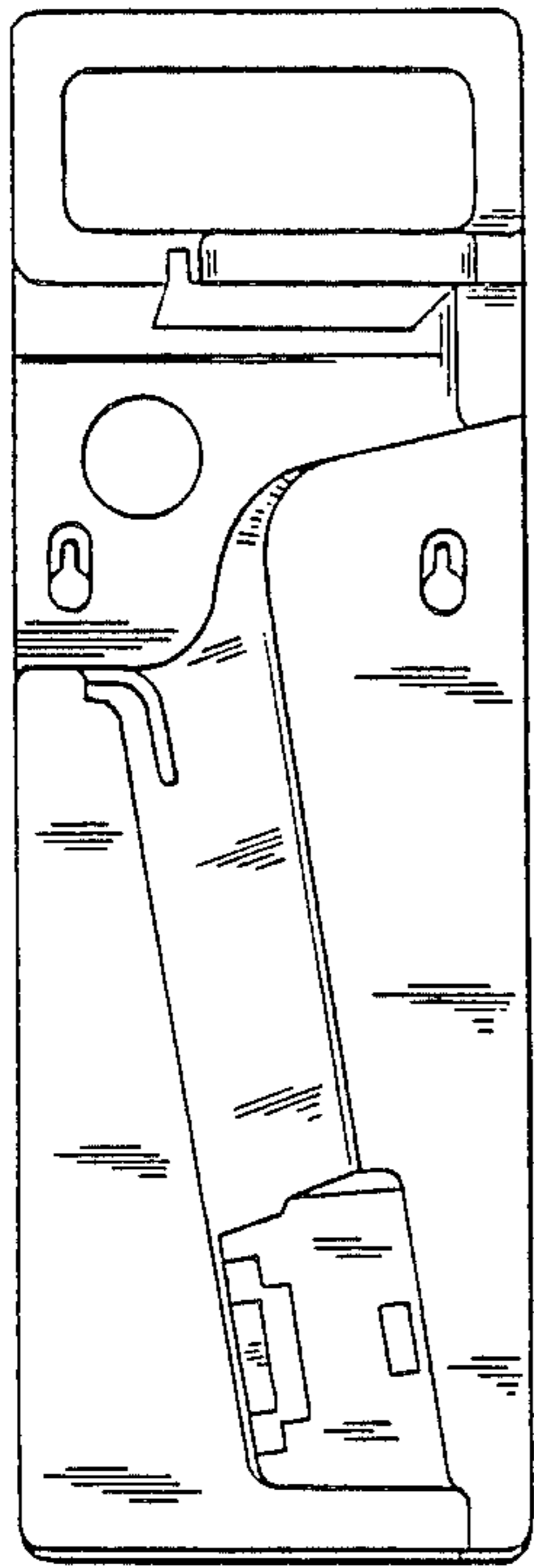

FIG. 1

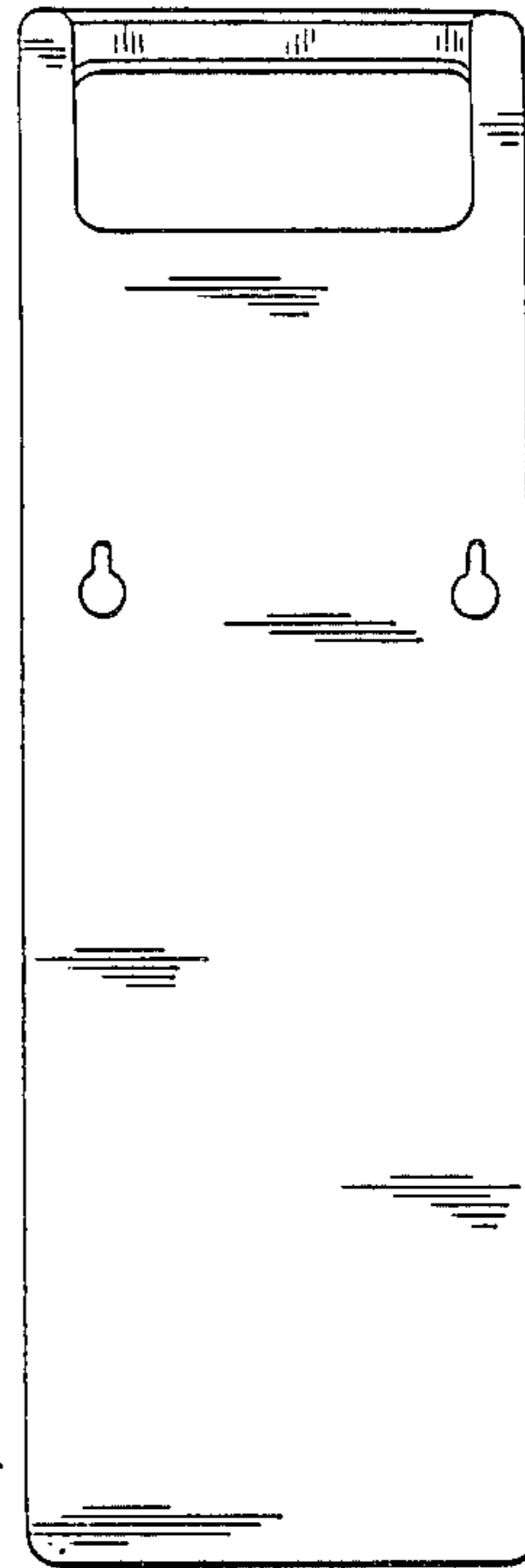

FIG. 2

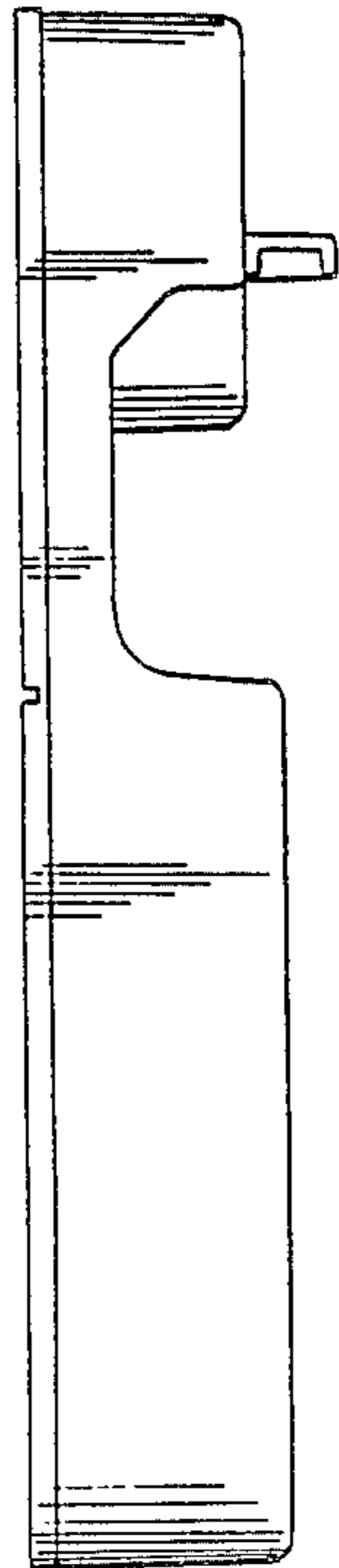

FIG. 3

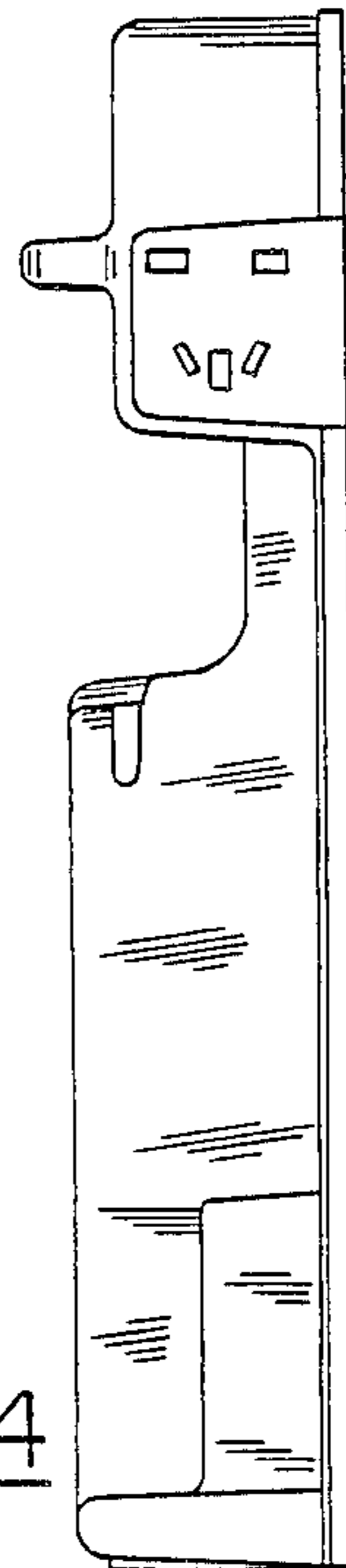

FIG. 4

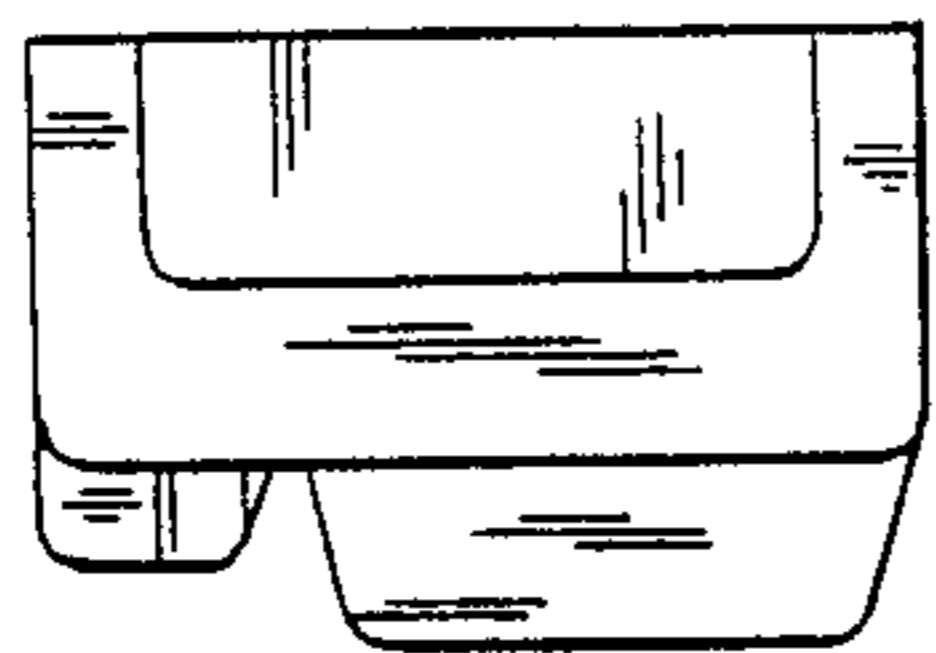

FIG. 5

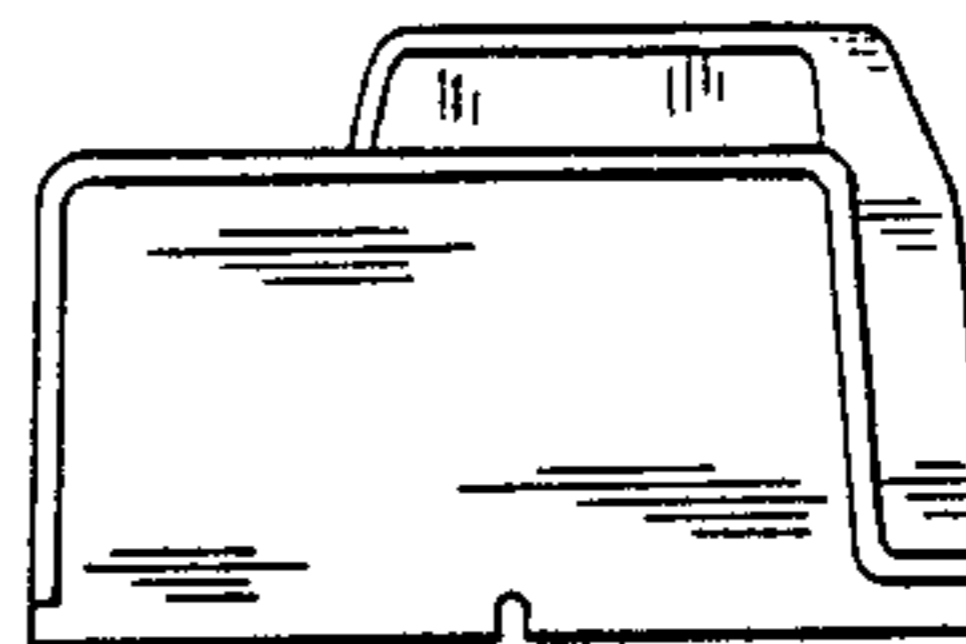

FIG. 6

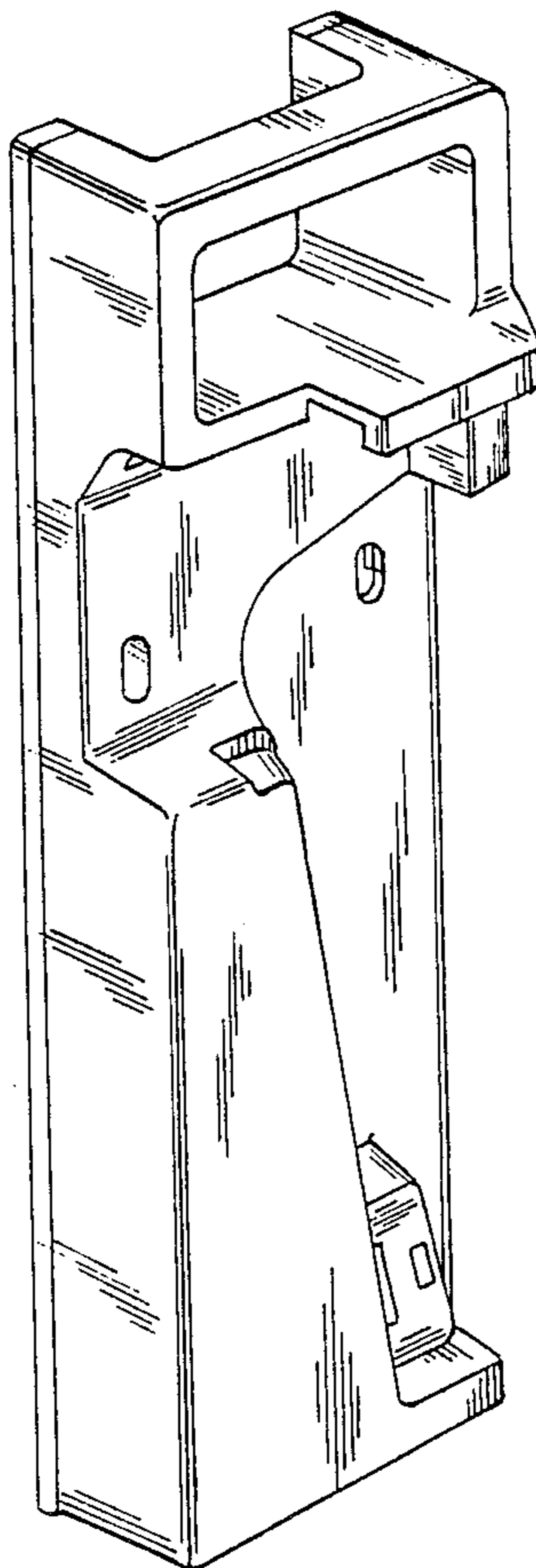

FIG. 7