

[54] PRINTER

[75] Inventor: Nobufusa Kuroki, Machida, Japan

[73] Assignee: Janome Sewing Machine Co. Ltd., Tokyo, Japan

[\*\*] Term: 14 Years

[21] Appl. No.: 722,181

[22] Filed: Apr. 10, 1985

[30] Foreign Application Priority Data

Nov. 13, 1984 [JP] Japan ..... 59-46460

[52] U.S. Cl. .... D14/111; D18/13

[58] Field of Search ..... D14/100, 107, 111, 114; D18/13, 22; 400/689-691

[56] References Cited

U.S. PATENT DOCUMENTS

D. 281,247 11/1985 Lahey et al. .... D14/111

D. 284,013 5/1986 Kuroki ..... D18/13

OTHER PUBLICATIONS

Infoworld, 12-19-1983, p. 22, Star TM printer. Meridian Ltd. "The Dedicated Line TM" catalog, 1983, p. 2, Diablo printer. NEC Information Systems, Inc. Spinwriter® user's guide, 5-1982, front cover, printer (center).

Primary Examiner—Susan J. Lucas  
Attorney, Agent, or Firm—Michael J. Striker

[57] CLAIM

The ornamental design for a printer, substantially as shown and described.

DESCRIPTION

FIG. 1 is a front elevational view of a printer showing my new design;  
FIG. 2 is a rear elevational view thereof;  
FIG. 3 is a left side elevational view thereof;  
FIG. 4 is a right side elevational view thereof;  
FIG. 5 is a top plan view thereof;  
FIG. 6 is a bottom plan view thereof;  
FIG. 7 is a front perspective view thereof;  
FIG. 8 is a cross sectional view thereof as taken along line 8-8 of FIG. 1.

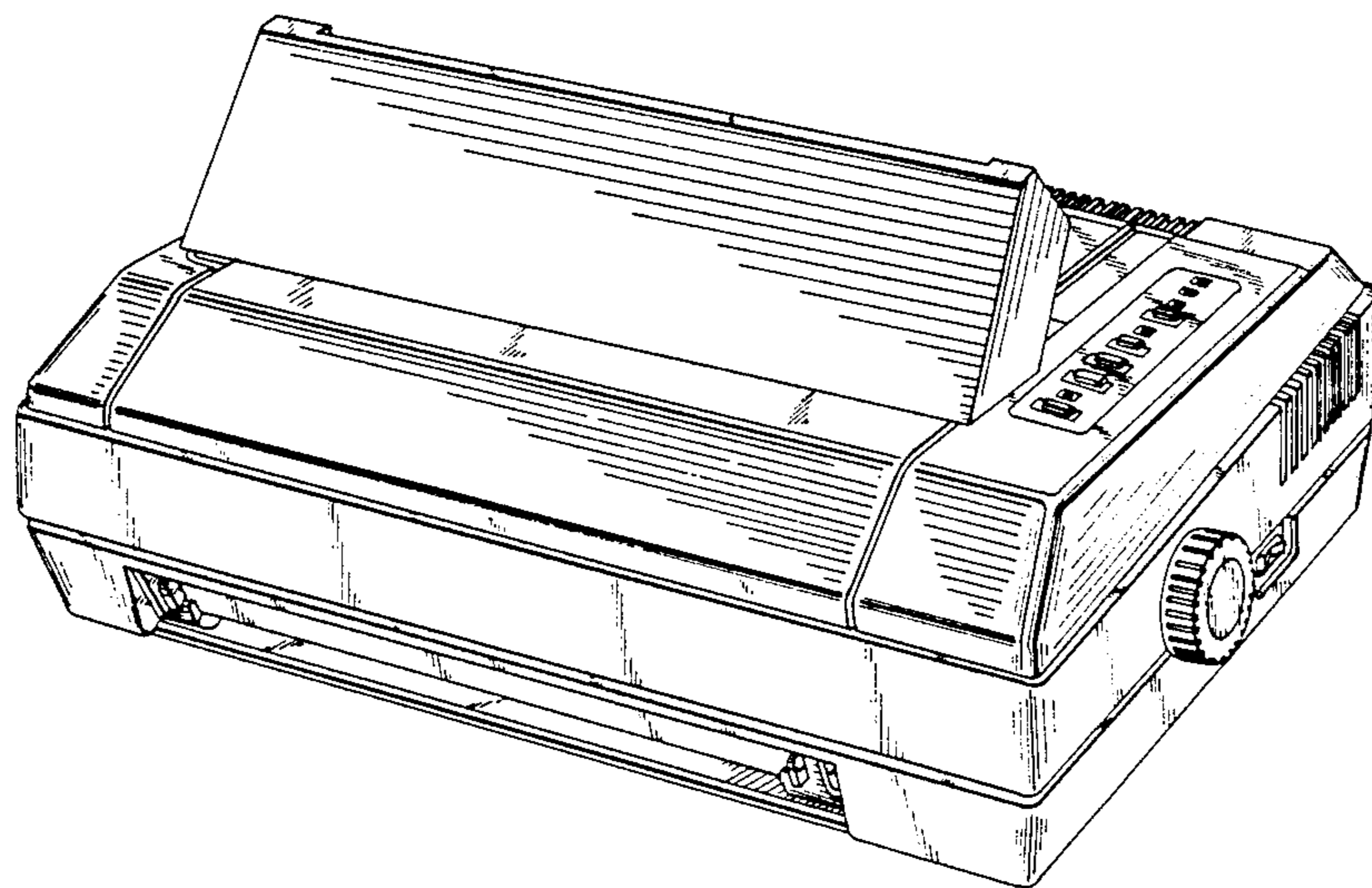

FIG. 1

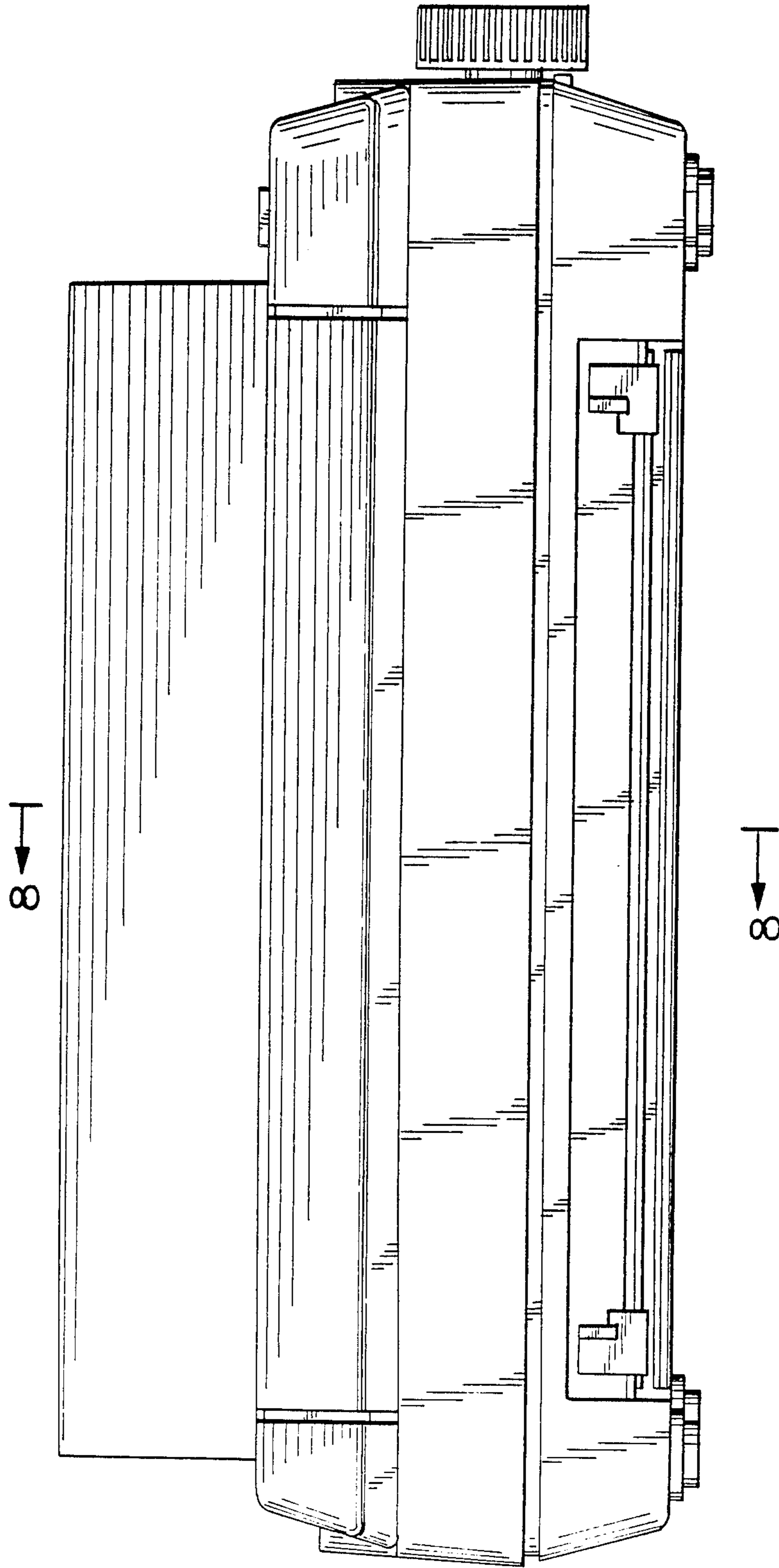

FIG. 2

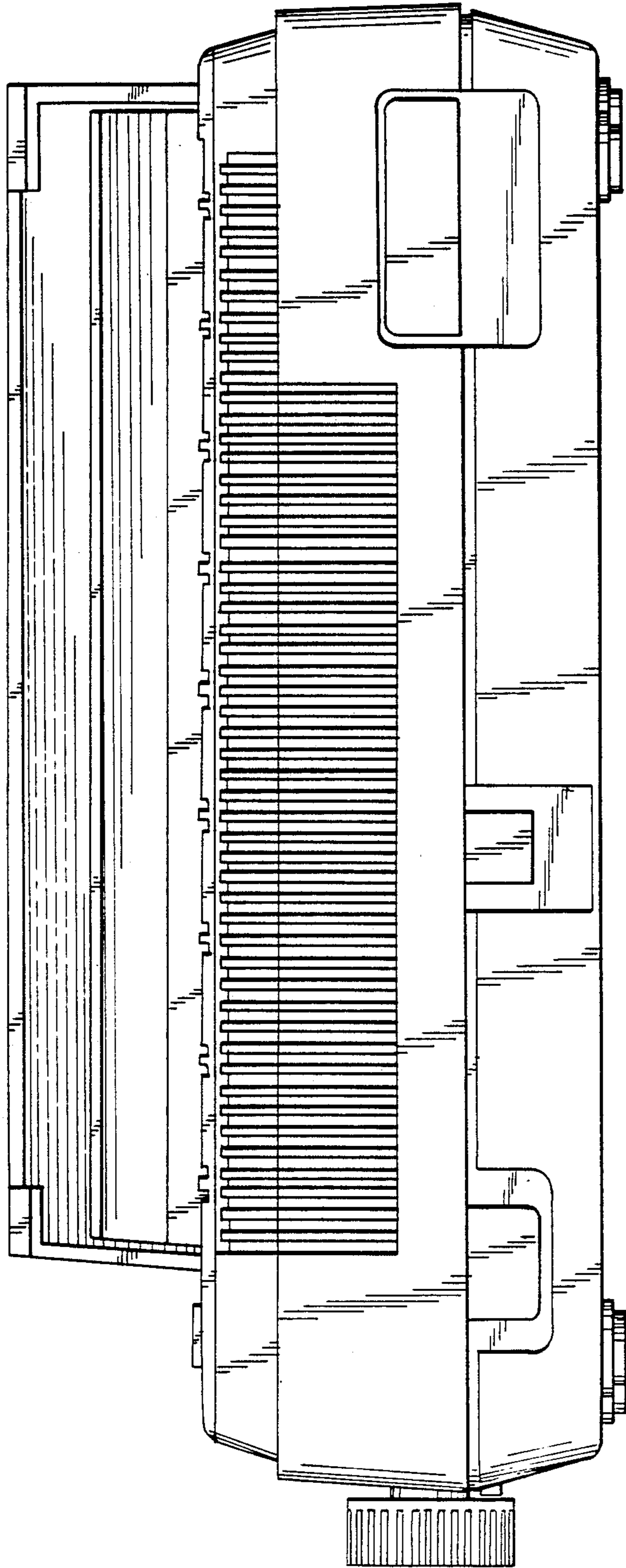

FIG. 3

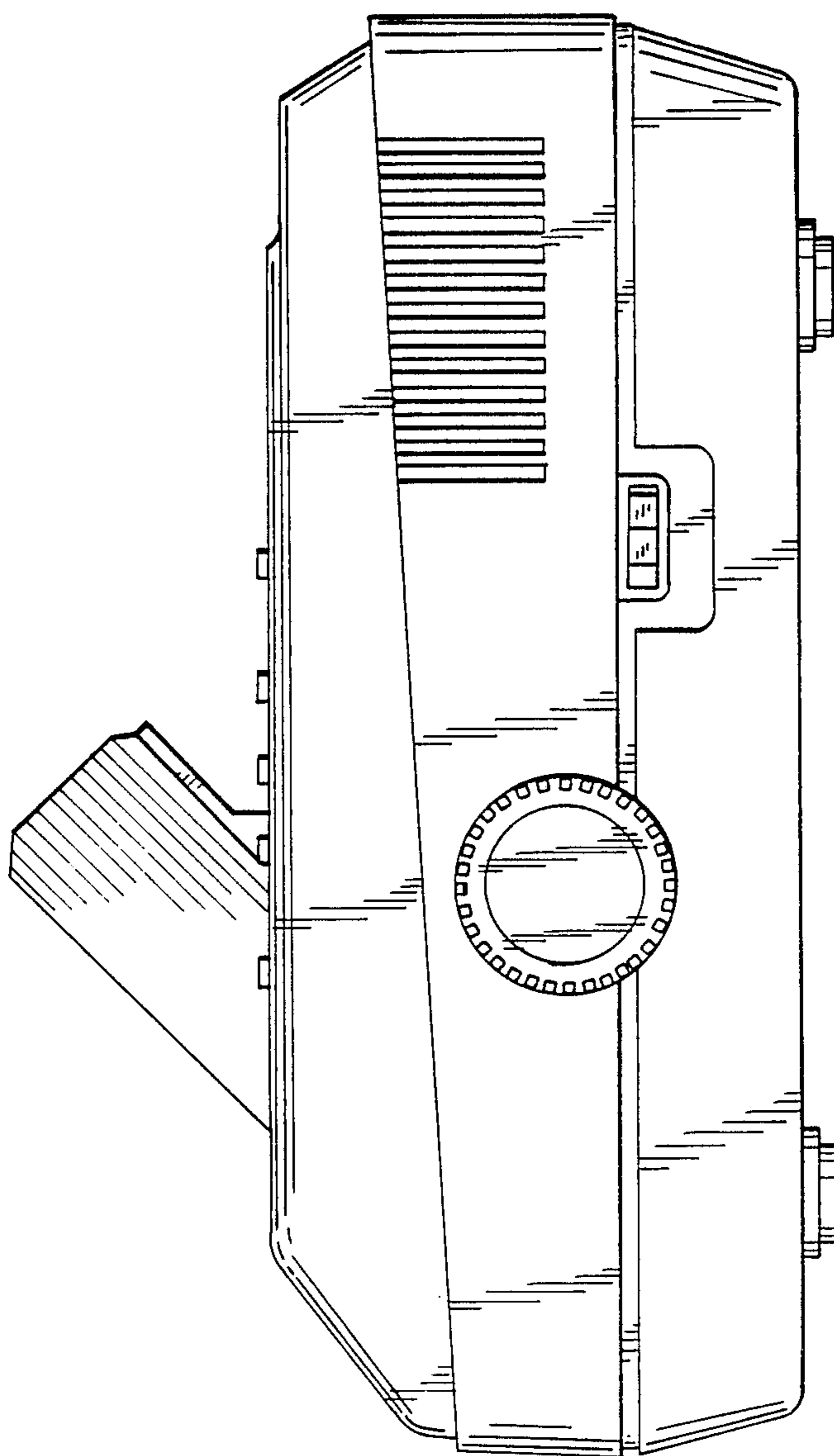

FIG. 4

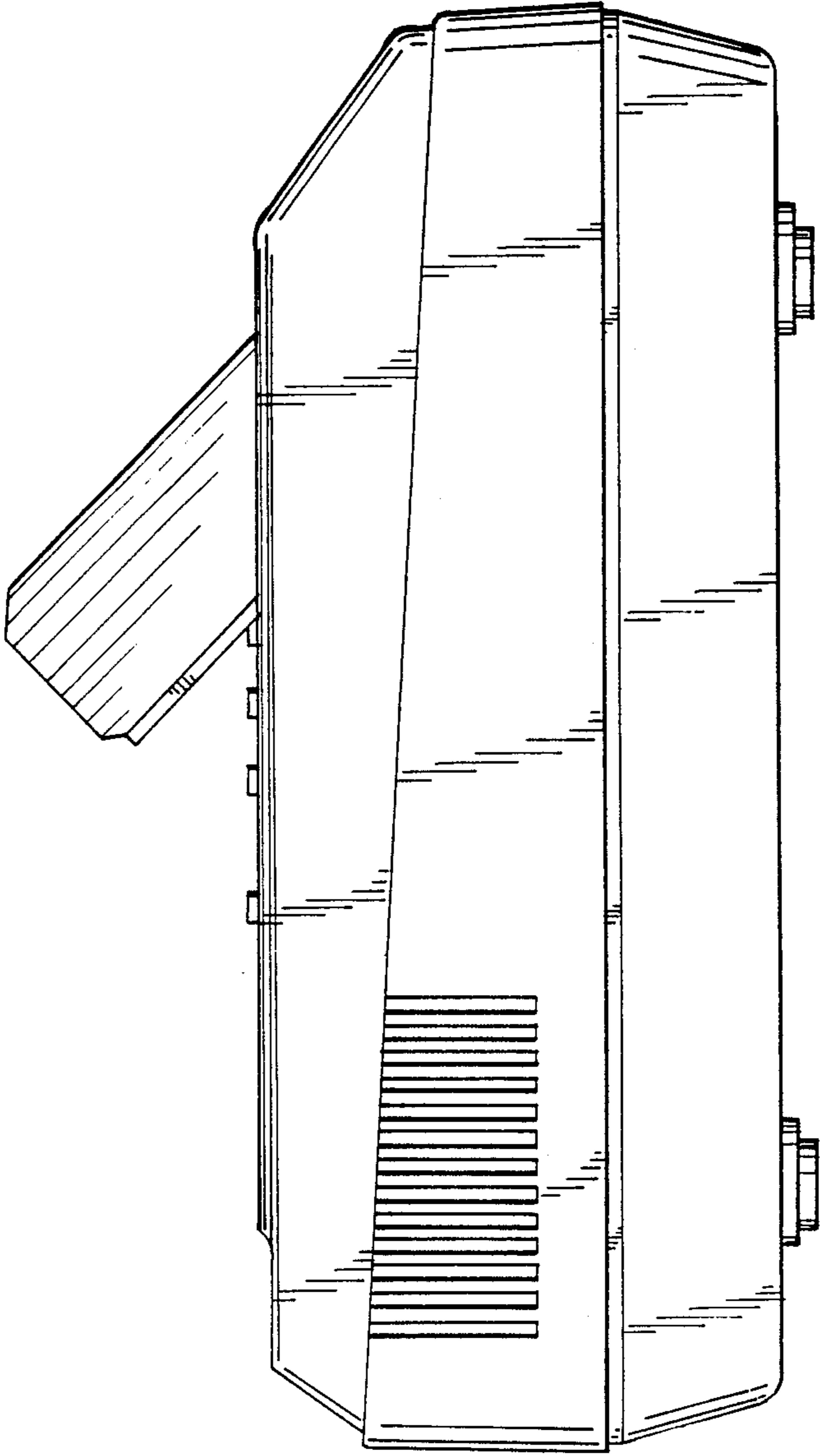



FIG 5

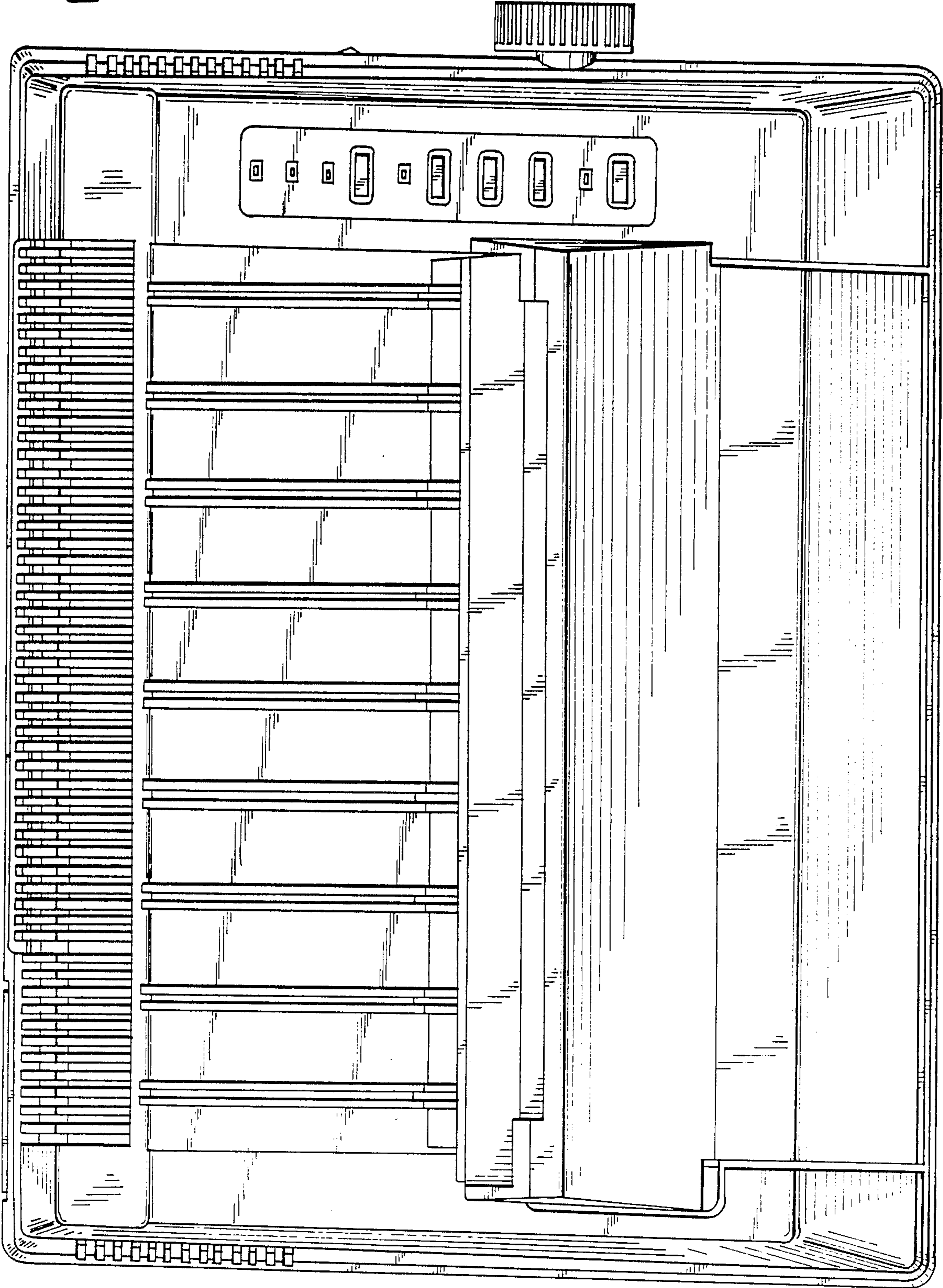

FIG. 6

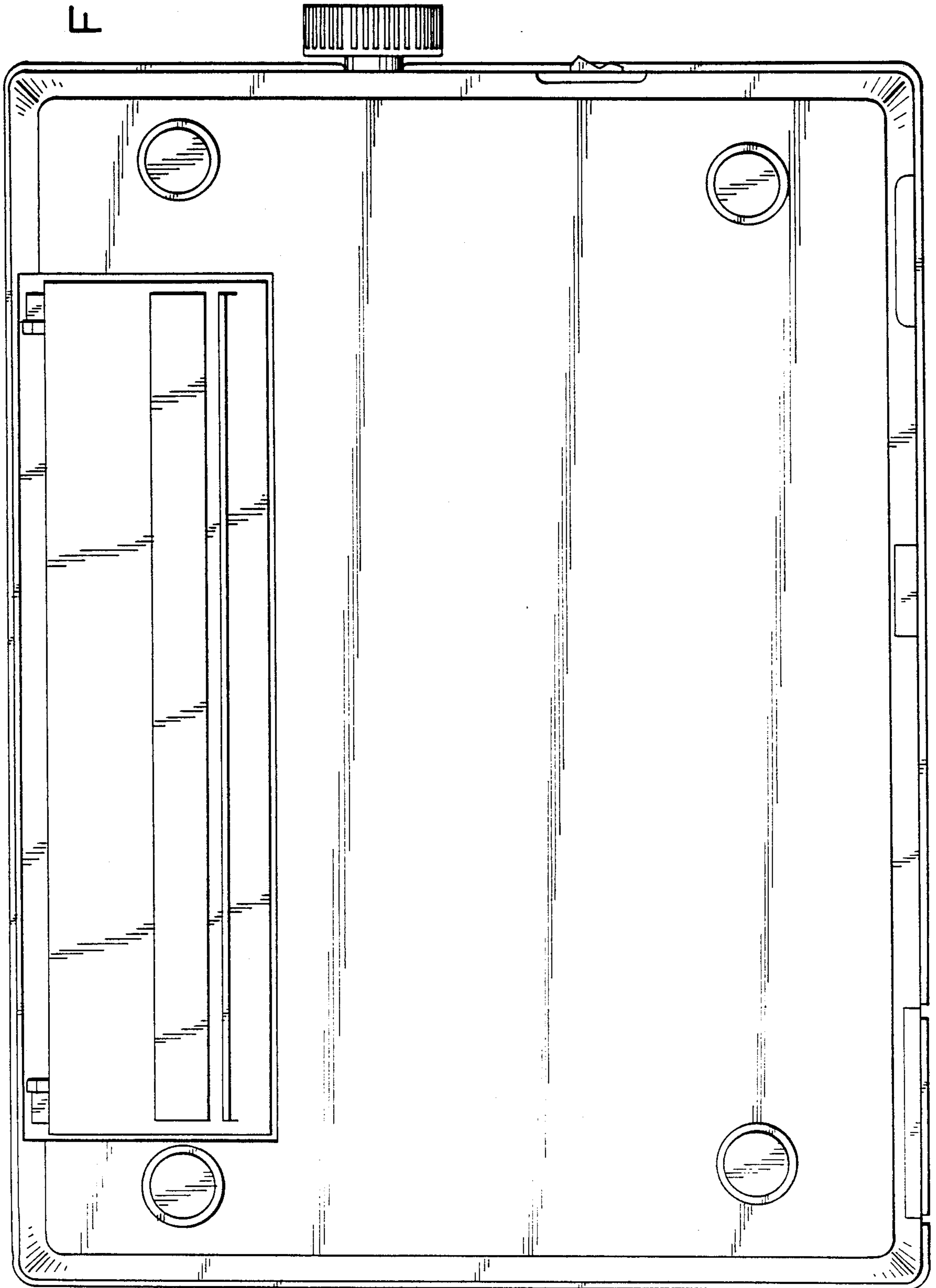

FIG. 7

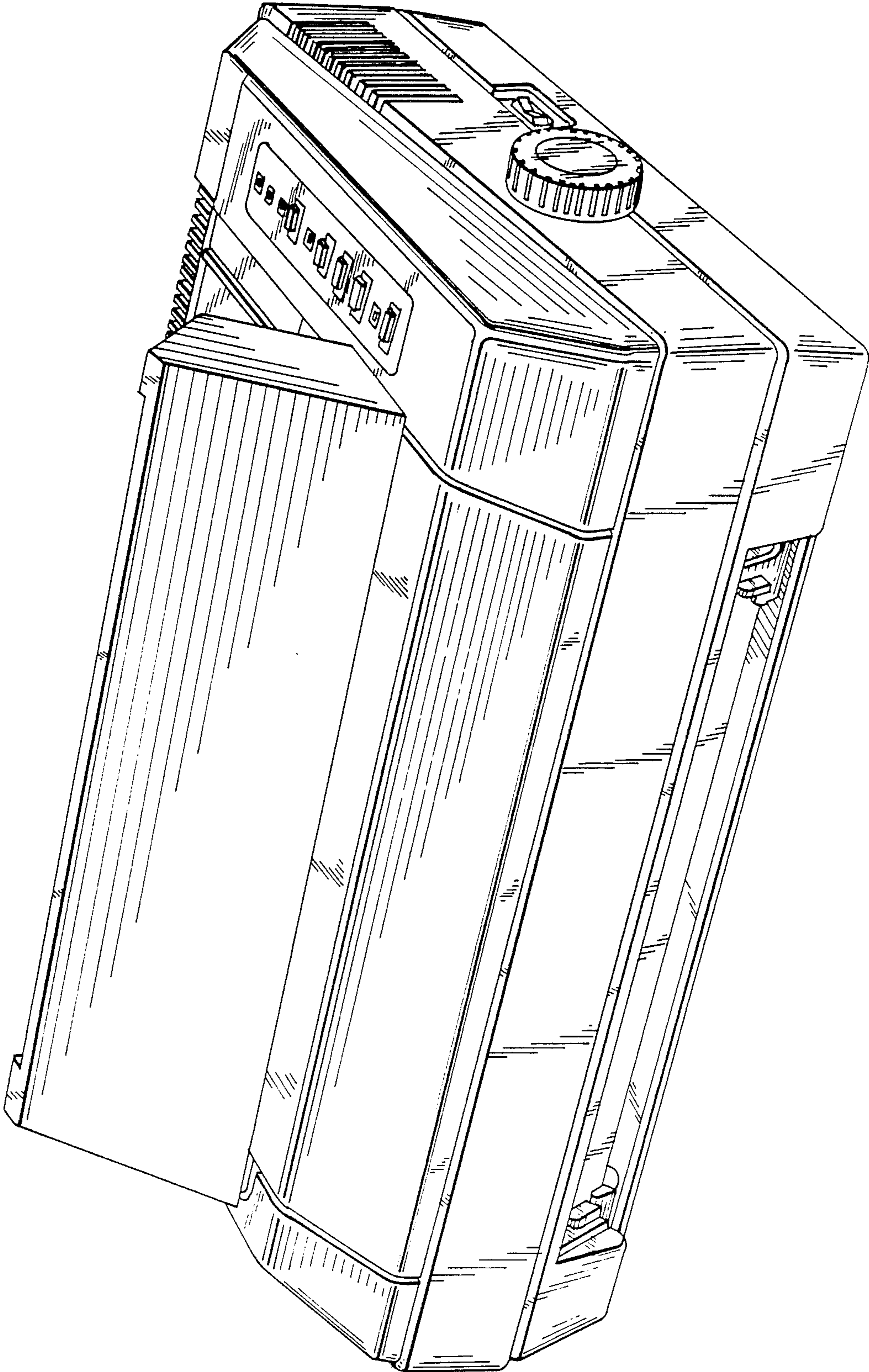



FIG. 8

