

[54] TELEVISION MODULE

[56] References Cited

[75] Inventors: Arnold R. Stevnton, Valencia;  
Robert F. Butler, Encino, both of  
Calif.

- U.S. PATENT DOCUMENTS
- D. 213,144 1/1969 Kraus et al. .... D12/195
  - D. 253,293 10/1979 Takaichi et al. .... D21/13
  - D. 259,038 4/1981 Smith ..... D12/345 X
  - D. 281,940 12/1985 Stevnton et al. .... D6/492

[73] Assignee: Aviation Entertainment Corporation,  
Valencia, Calif.

Primary Examiner—Bernard Ansher  
Assistant Examiner—Theodore M. Shooman  
Attorney, Agent, or Firm—Kelly, Bauersfeld & Lowry

[\*\*] Term: 14 Years

[57] CLAIM

The ornamental design for a television module, as shown and described.

[21] Appl. No.: 806,352

DESCRIPTION

[22] Filed: Nov. 25, 1985

FIG. 1 is a front, bottom and left side perspective view of a television module showing our new design;  
FIG. 2 is a bottom plan view thereof;  
FIG. 3 is a front elevational view thereof;  
FIG. 4 is a top plan view thereof;  
FIG. 5 is a right side elevational view thereof;  
FIG. 6 is a left side elevational view thereof; and  
FIG. 7 is a rear elevational view thereof.

[52] U.S. Cl. .... D14/77; D12/345;  
D12/192; D6/492

[58] Field of Search ..... D14/77, 79-85,  
D14/99, 113; D12/195, 345, 192; D21/13;  
358/254, 255; D6/492, 356

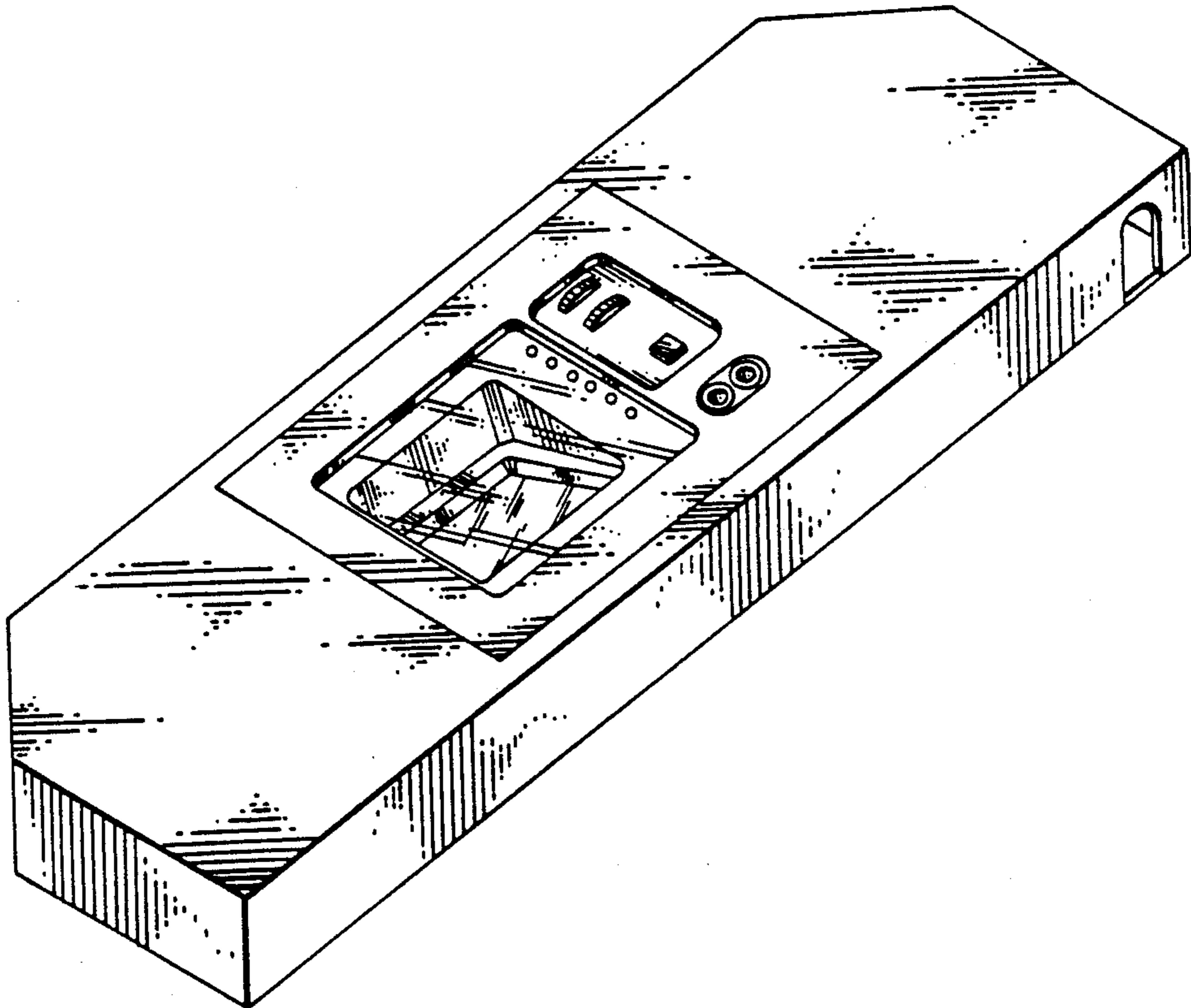

FIG. 1

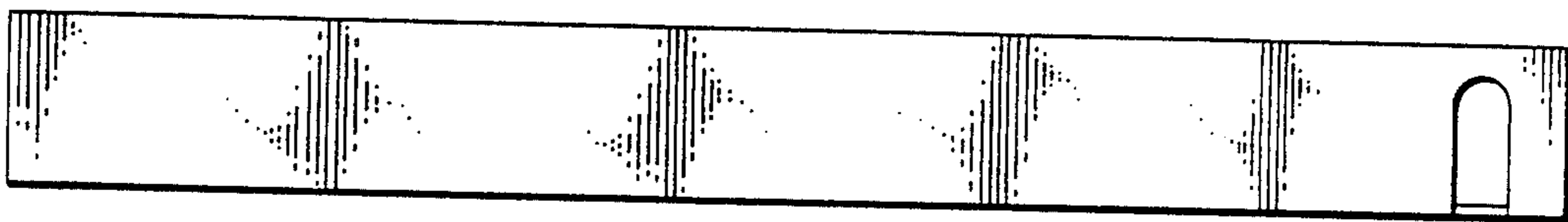
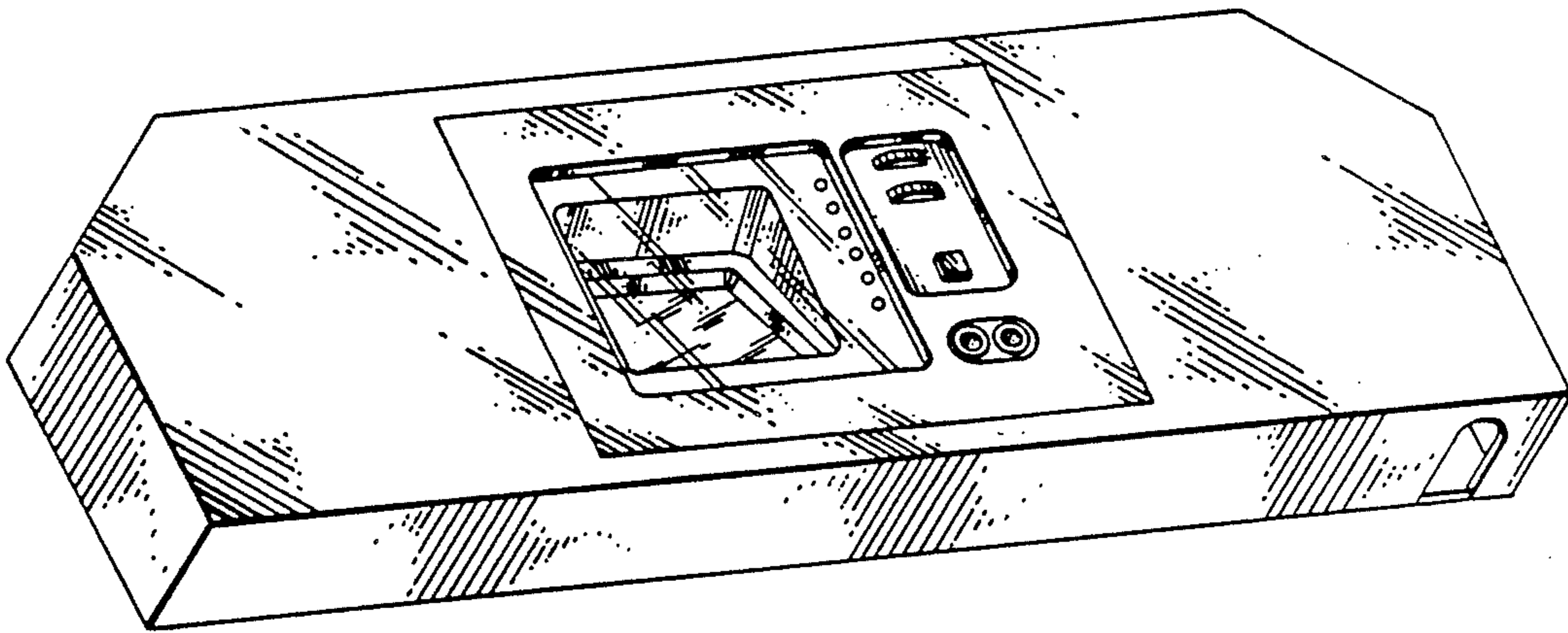

FIG. 2

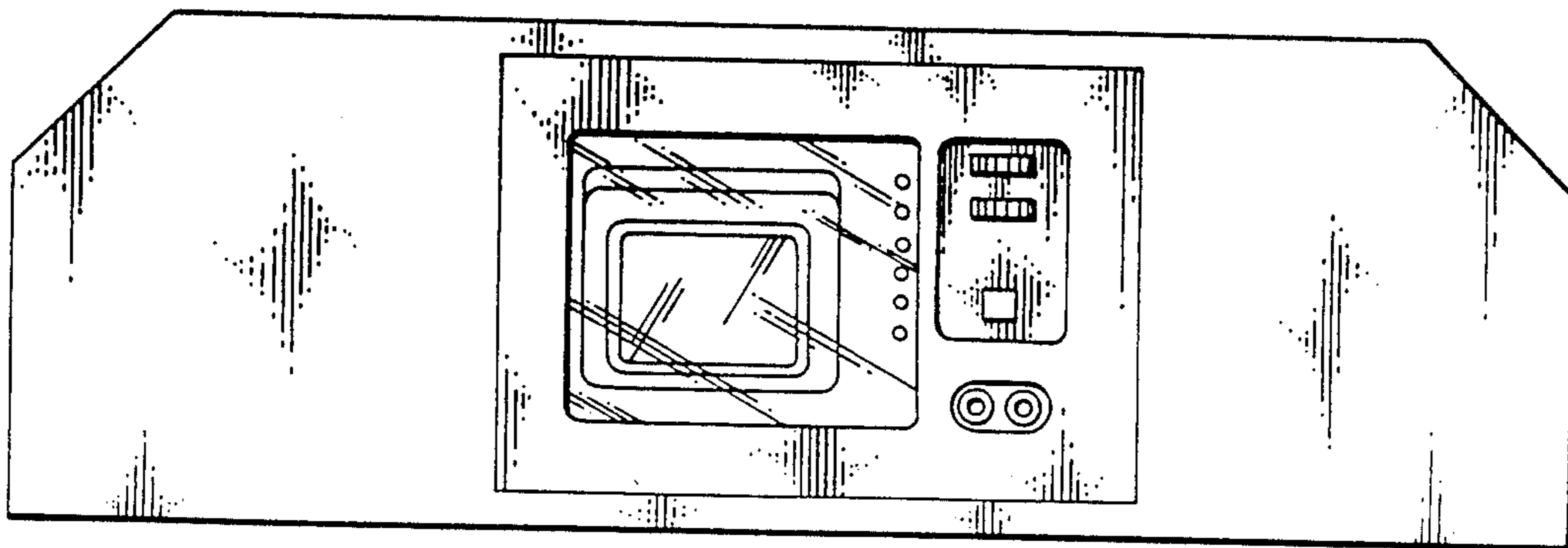

FIG. 3

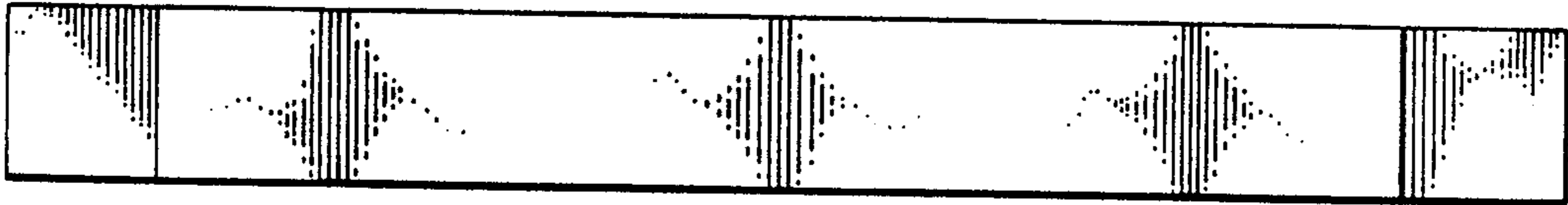

FIG. 4

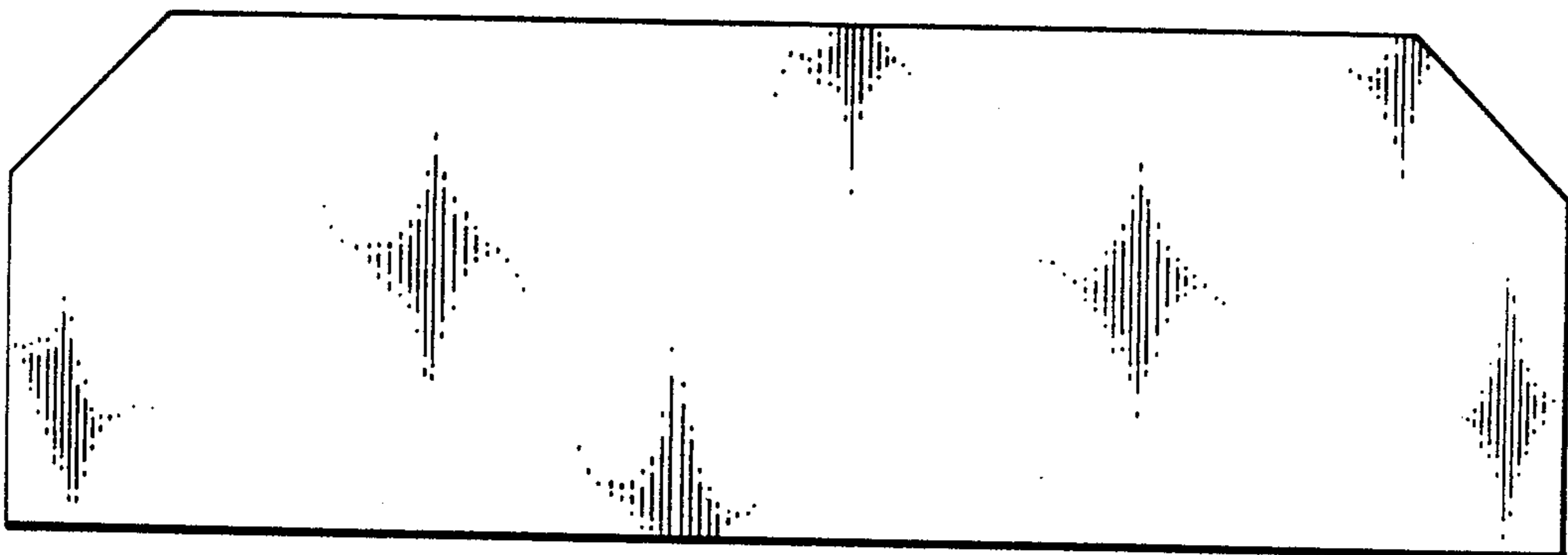

FIG. 5

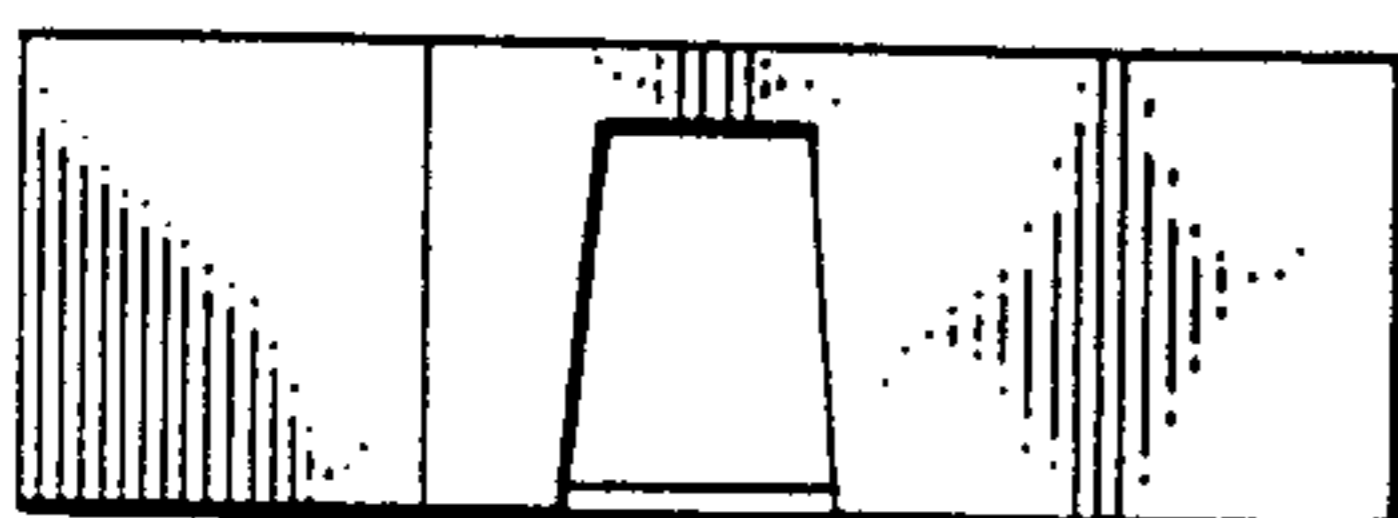

FIG. 6

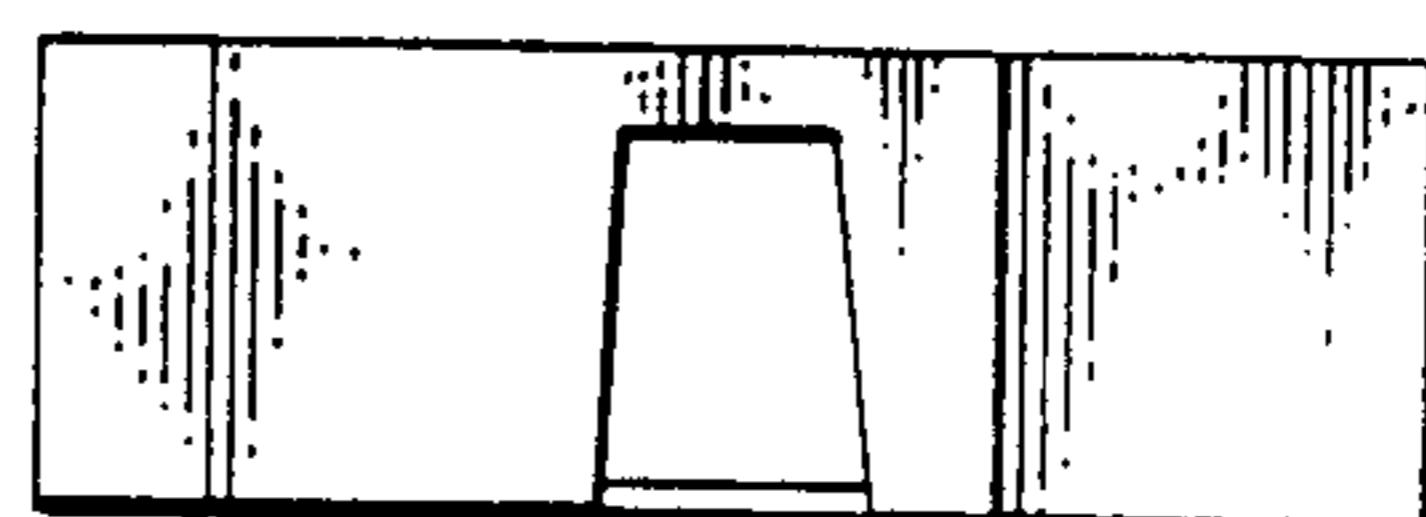

FIG. 7