

[54] **MANUAL WINDOW WASHER DEVICE**

[76] **Inventor: Danny R. Jinkins, 337 Center St.,
Bryan, Ohio 43506**

[**] **Term: 14 Years**

[21] **Appl. No.: 692,174**

[22] **Filed: Jan. 17, 1985**

[52] **U.S. Cl. D32/45; D9/338**

[58] **Field of Search D32/40-42,
D32/45; D9/338; 15/105, 118, 121, 244, 245;
401/16, 23, 25, 27, 137-139, 143, 188 R, 192,
195, 196; D4/116, 118**

[56] **References Cited**

U.S. PATENT DOCUMENTS

D. 235,411	6/1975	Savage	D4/118
D. 236,072	7/1975	Tsang	D32/41
D. 247,543	3/1978	Savage	D4/118
2,147,769	2/1939	Epstein	401/139
2,583,432	1/1952	Leverock	15/244 R X
2,859,463	11/1958	Hirsch	401/139

2,886,839	5/1959	Leopoldi	401/139
3,603,692	9/1971	Ball et al.	401/139
3,837,747	9/1974	Seymore	401/25
4,013,369	3/1977	Turek	401/139

FOREIGN PATENT DOCUMENTS

3214500	10/1983	Fed. Rep. of Germany	15/121
1330348	9/1973	United Kingdom	401/139

Primary Examiner—Catherine E. Kemper

[57] **CLAIM**

The ornamental design for a manual window washer device, as shown and described.

DESCRIPTION

FIG. 1 is a left, front perspective view of a manual window washer device, showing my new design;
FIG. 2 is a left side elevational view thereof;
FIG. 3 is a right side elevational view thereof;
FIG. 4 is a rear elevational view thereof;
FIG. 5 is a front elevational view thereof;
FIG. 6 is a top plan view thereof;
FIG. 7 is a bottom plan view thereof.

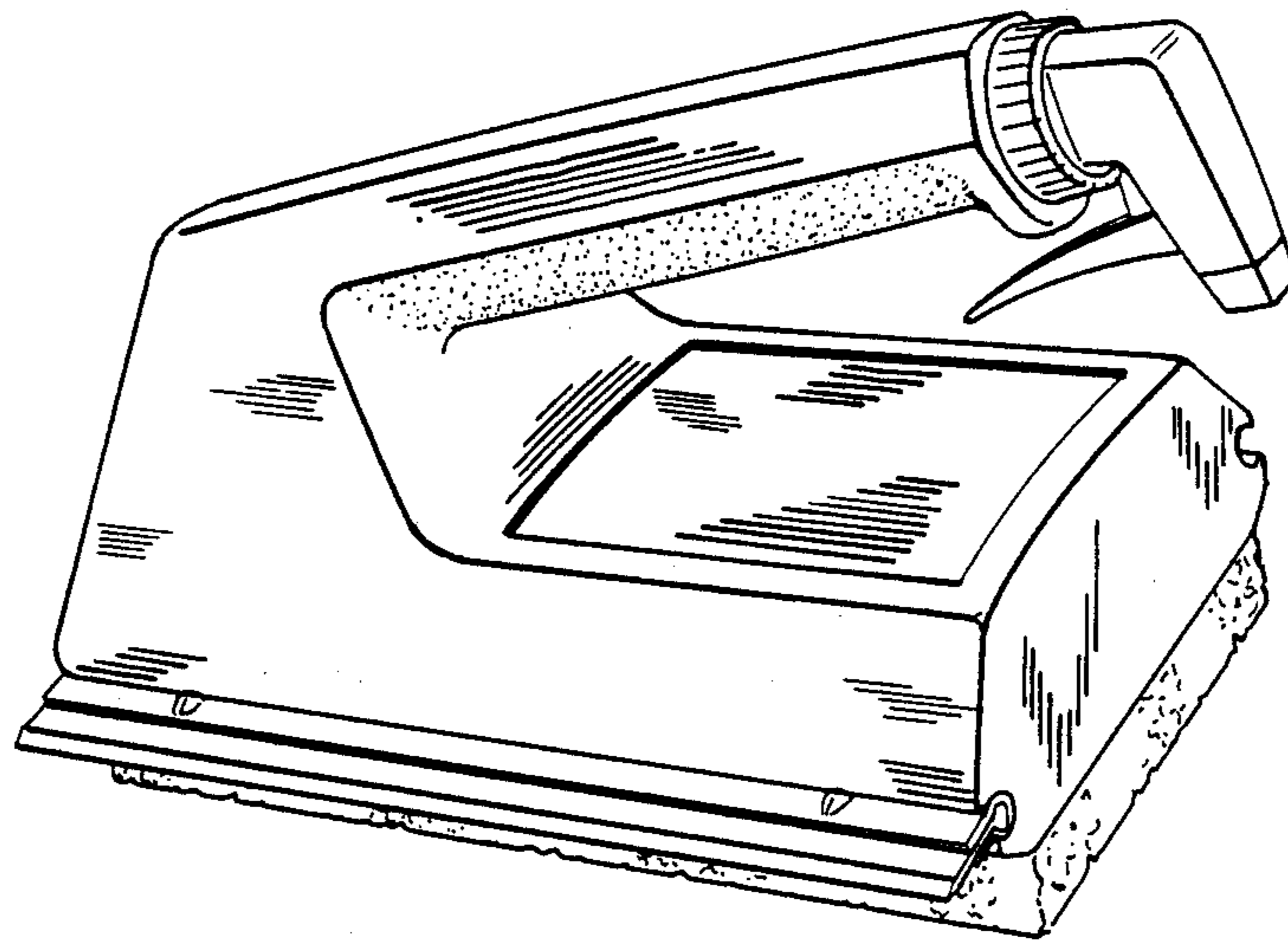

FIG. 1

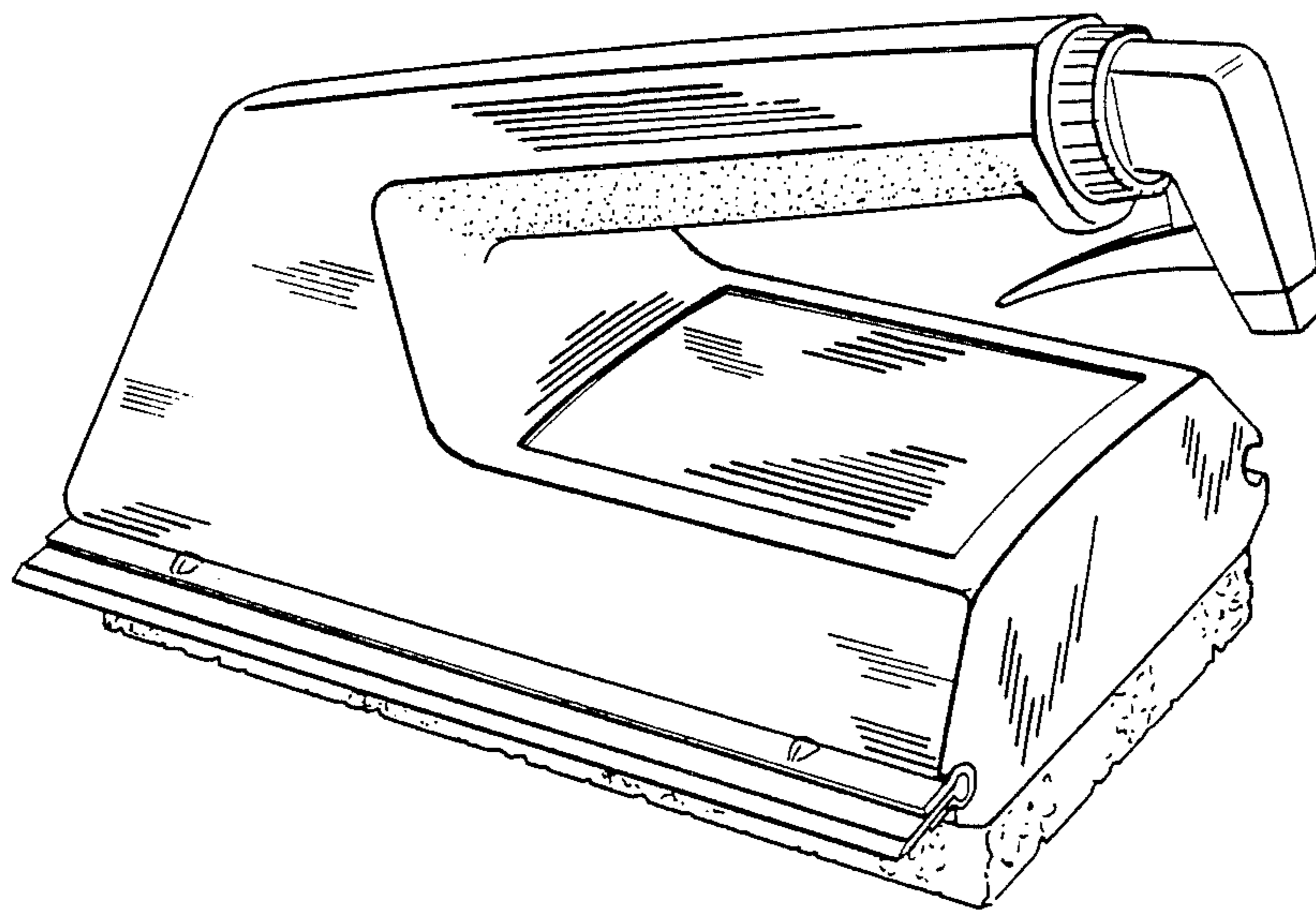

FIG. 2

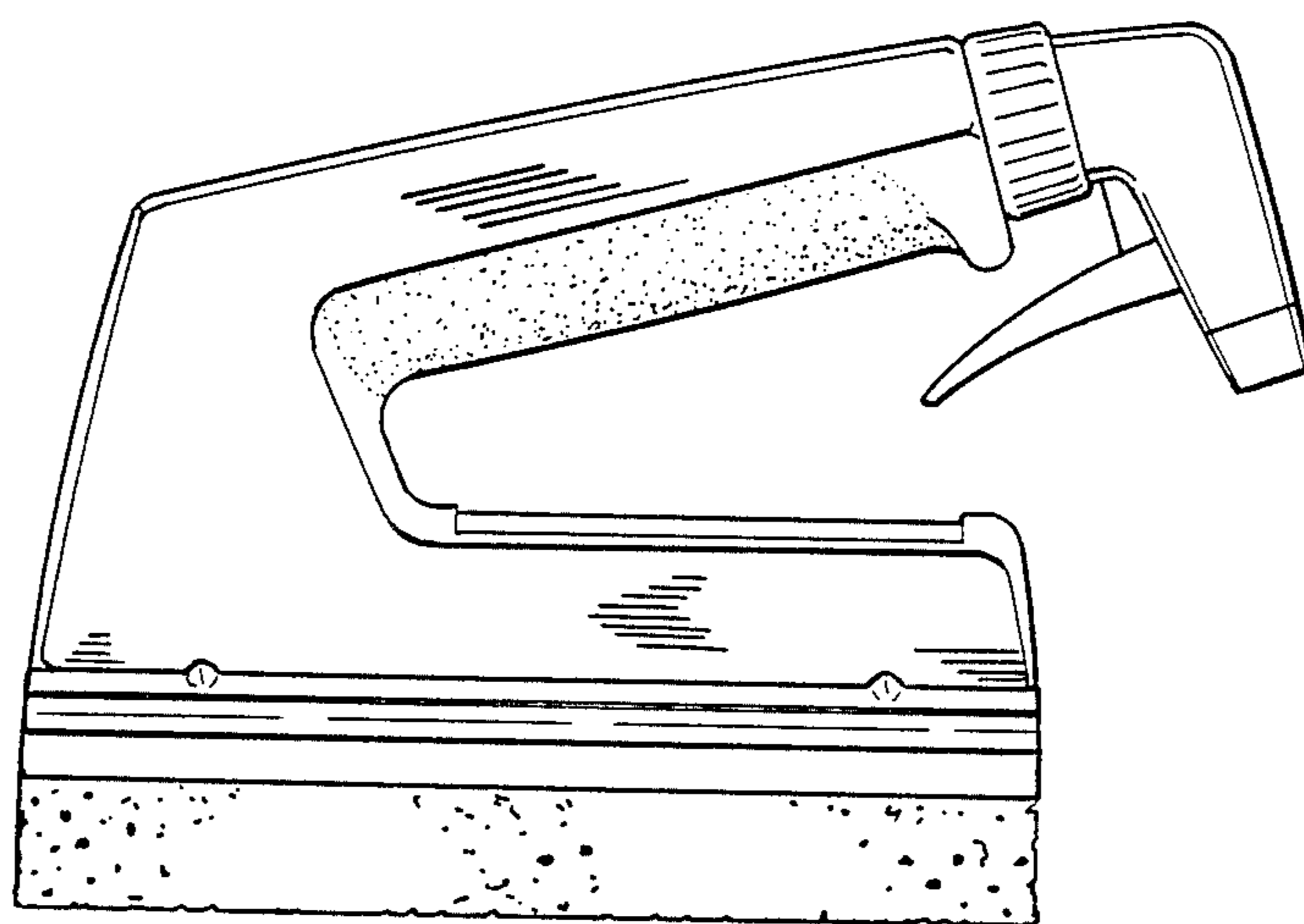

FIG. 3

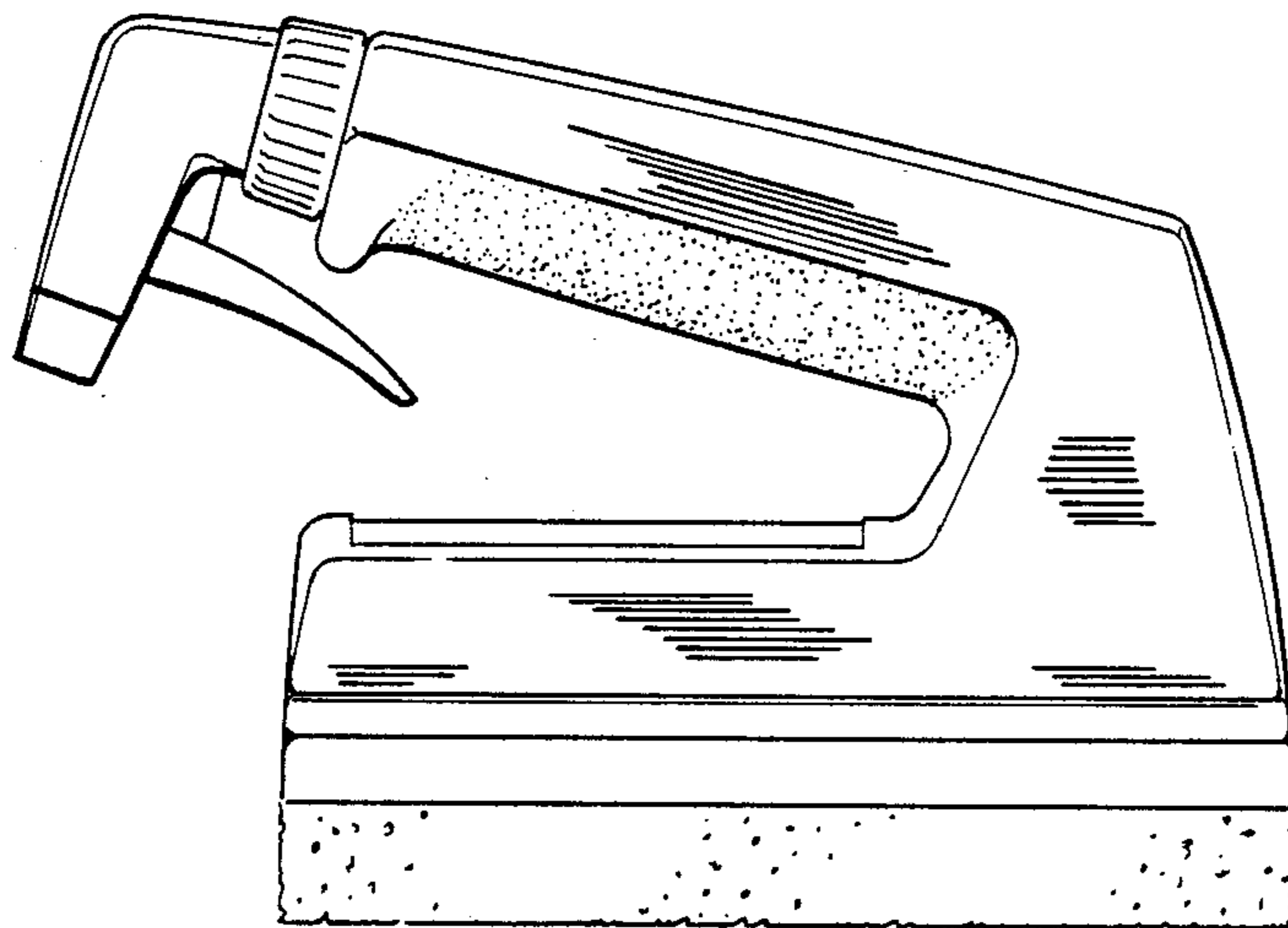

FIG. 4

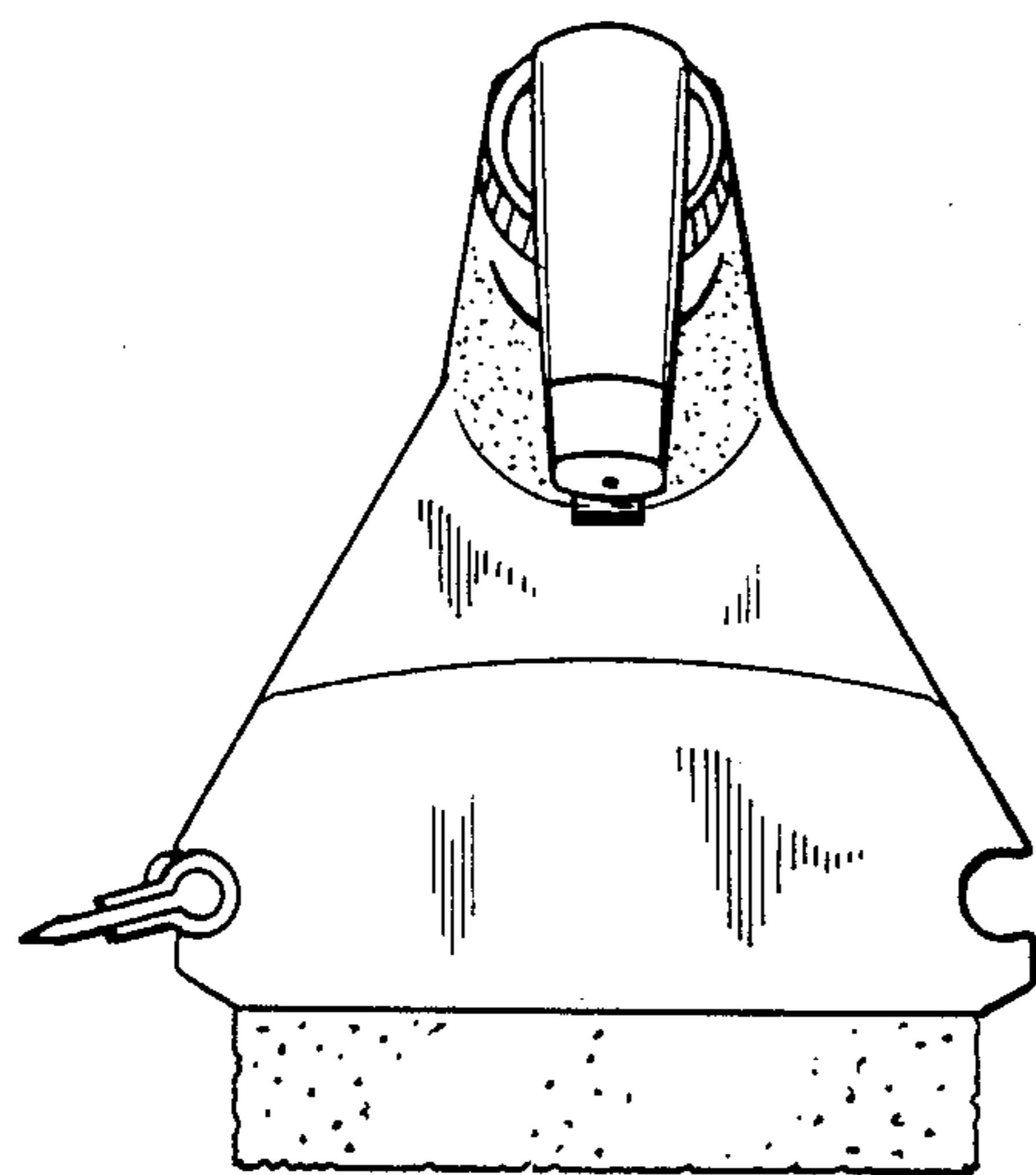

FIG. 5

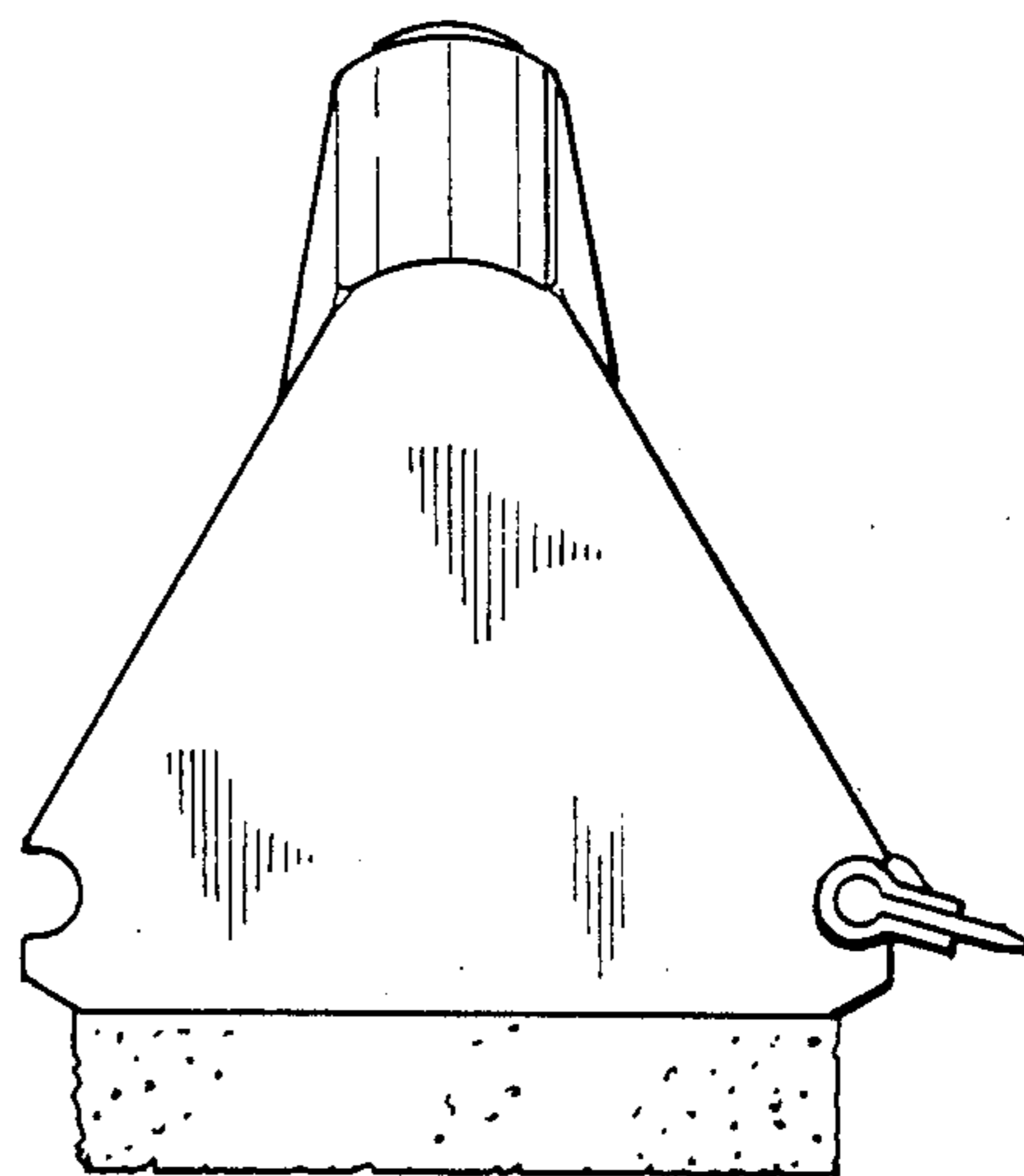

FIG. 6

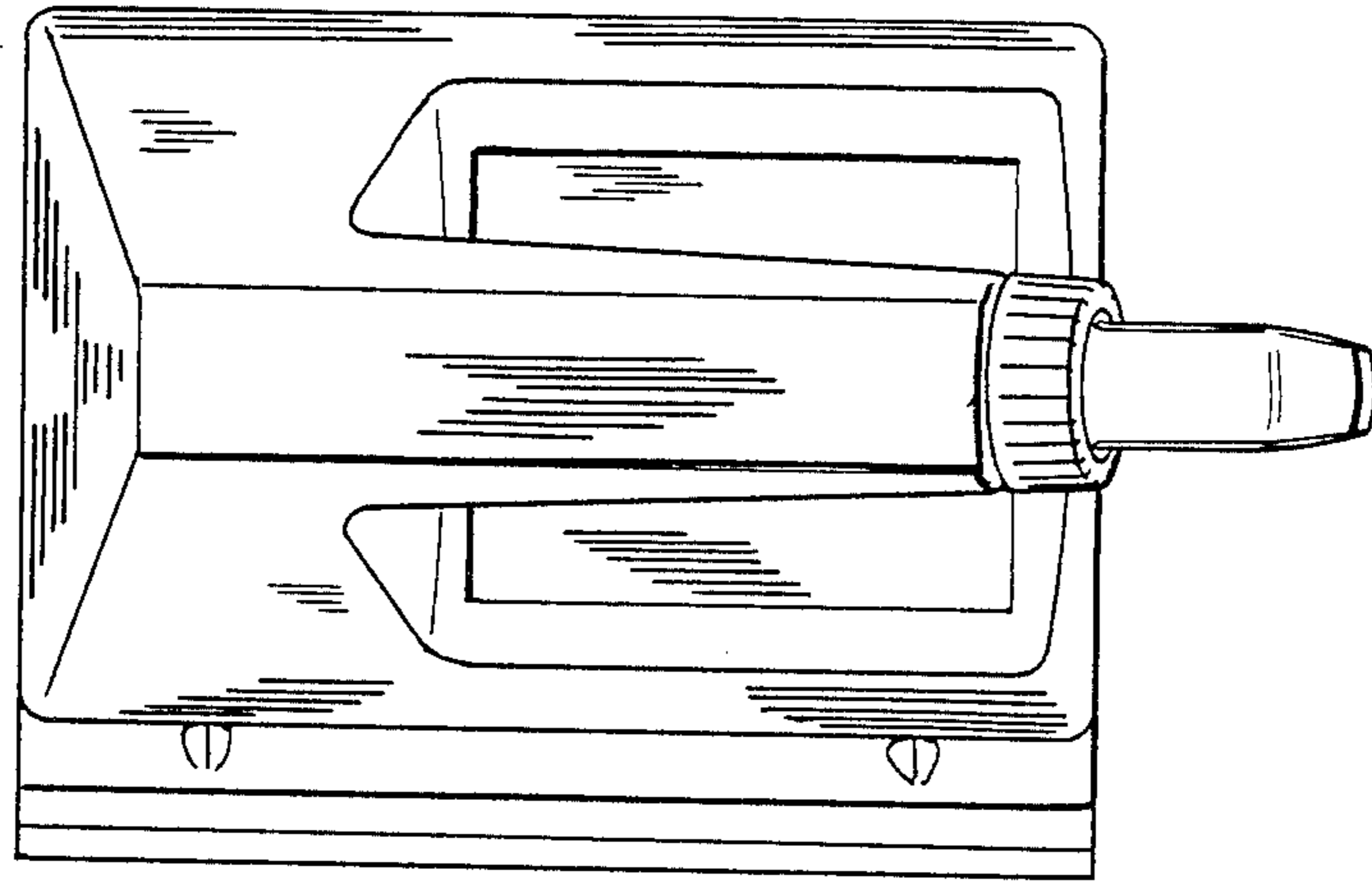

FIG. 7

