

[54] **ROLL PAPER HOLDER FOR PRINTER**

[75] **Inventor: Hiromitsu Nagahiro, Ube, Japan**

[73] **Assignee: Citizen Watch Company, Limited,
Tokyo, Japan**

[**] **Term: 14 Years**

[21] **Appl. No.: 805,222**

[22] **Filed: Nov. 15, 1985**

[30] **Foreign Application Priority Data**

Jul. 22, 1985 [JP] Japan 60-31009
[52] **U.S. Cl. D18/22**
[58] **Field of Search D18/12, 13, 22, 23,
D18/2, 7; D14/107, 111, 114; 400/689-694,
625, 629, 636, 638, 639, 641, 646, 647, 64.7**

[56] **References Cited**

U.S. PATENT DOCUMENTS

D. 247,198 2/1978 Ohie D18/7
D. 265,913 8/1982 Yoshioka et al. D18/7
3,333,671 8/1967 Rohde 400/646 X
4,341,480 7/1982 Mailer 400/647.1 X

Primary Examiner—Louis S. Zarfes

Attorney, Agent, or Firm—Cushman, Darby & Cushman

[57] **CLAIM**

The ornamental design for a roll paper holder for printer, as shown.

DESCRIPTION

FIG. 1 is a top, rear and right side perspective view of a roll paper holder for printer showing my new design; FIG. 2 is a bottom, front and right side perspective view thereof;

FIG. 3 is a front elevational view thereof;

FIG. 4 is a rear elevational view thereof;

FIG. 5 is a top plan view thereof;

FIG. 6 is a bottom plan view thereof, and

FIG. 7 is a right side elevational view thereof.

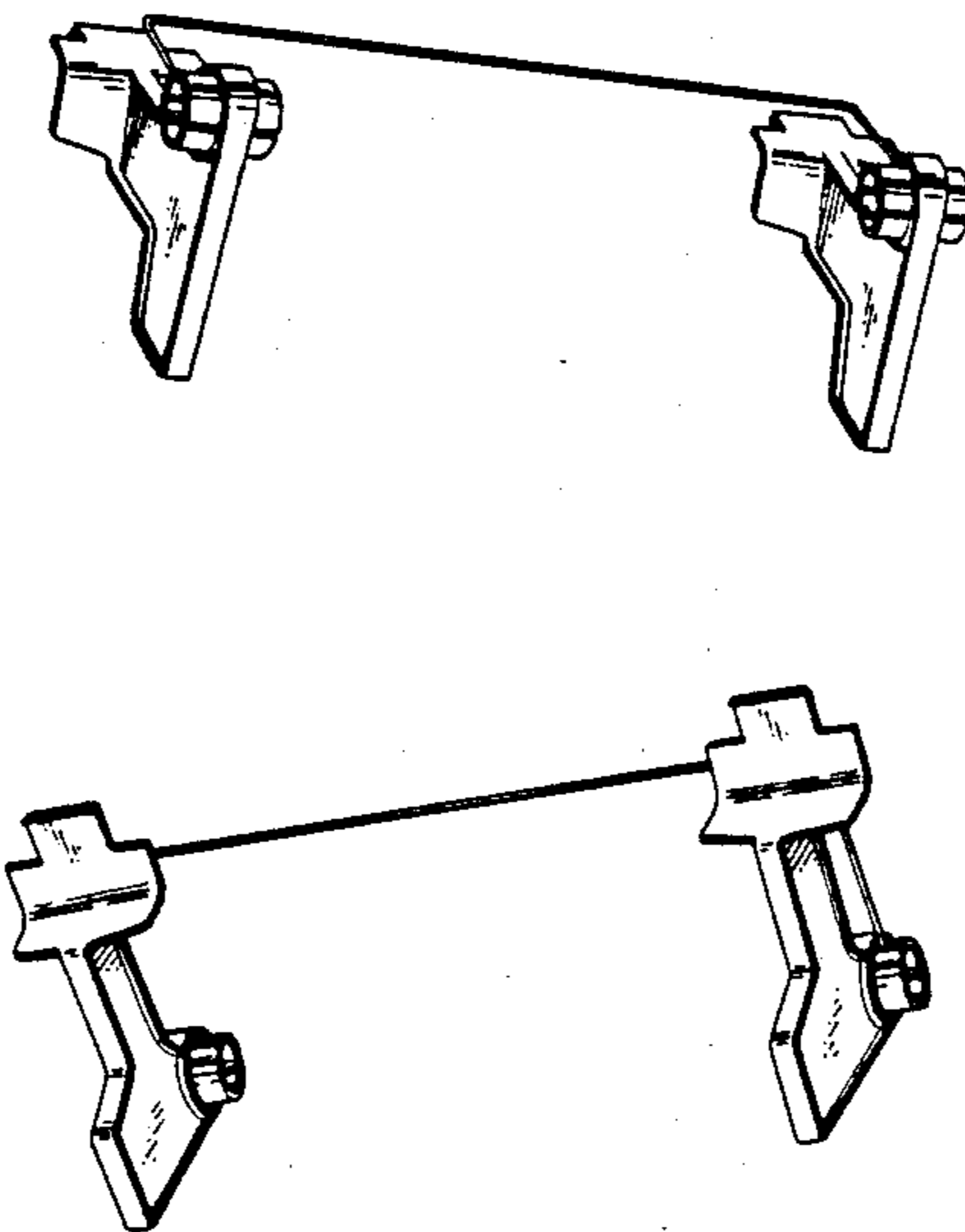

FIG. 1

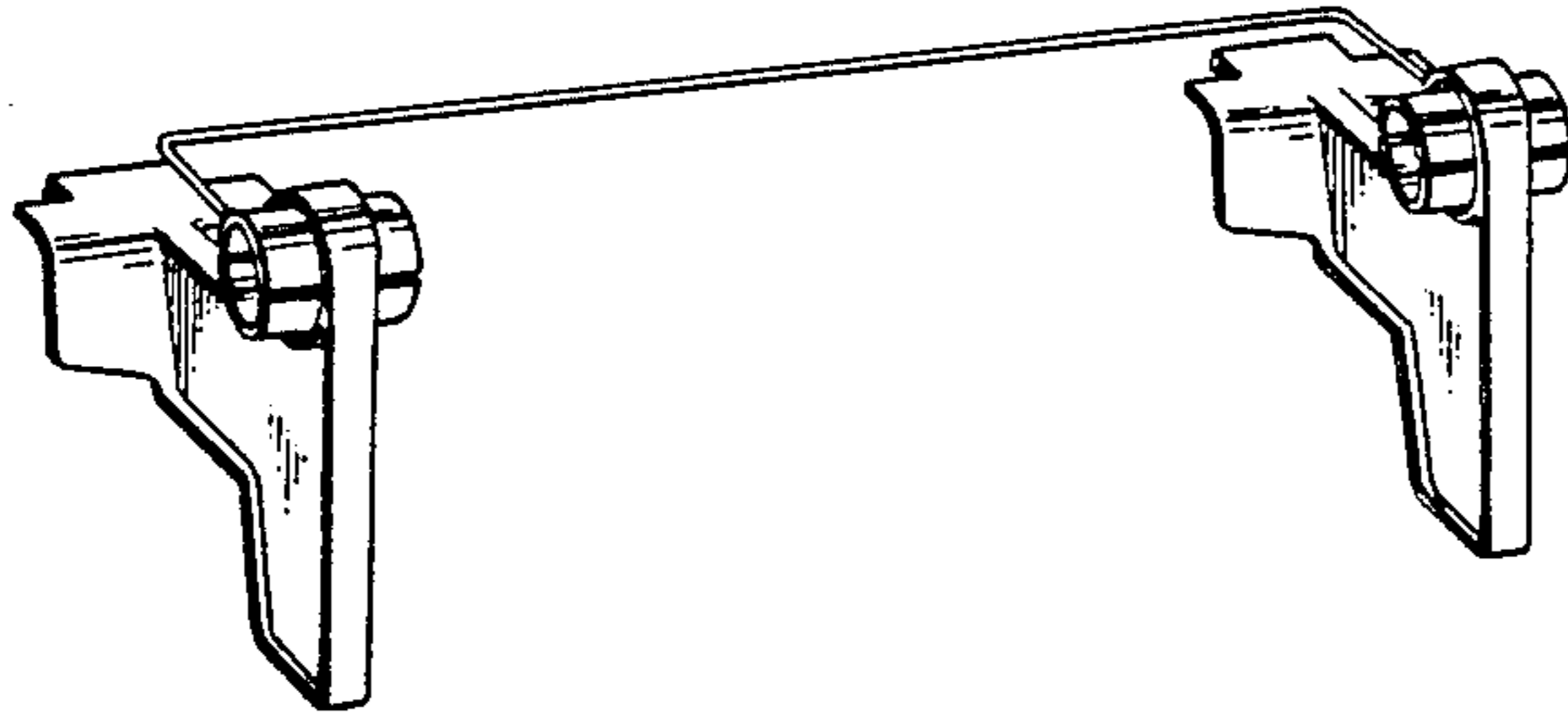

FIG. 2

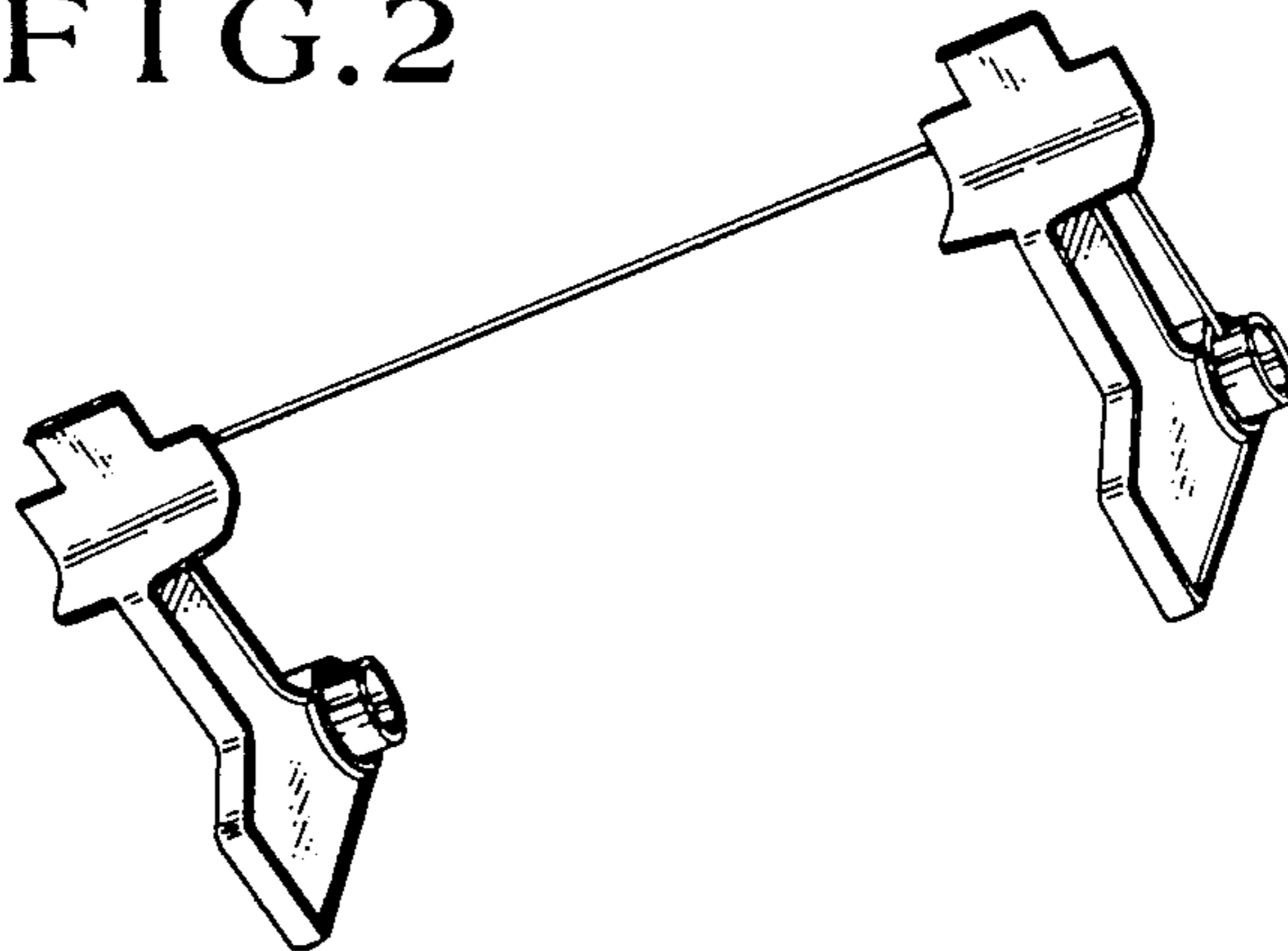

FIG. 3

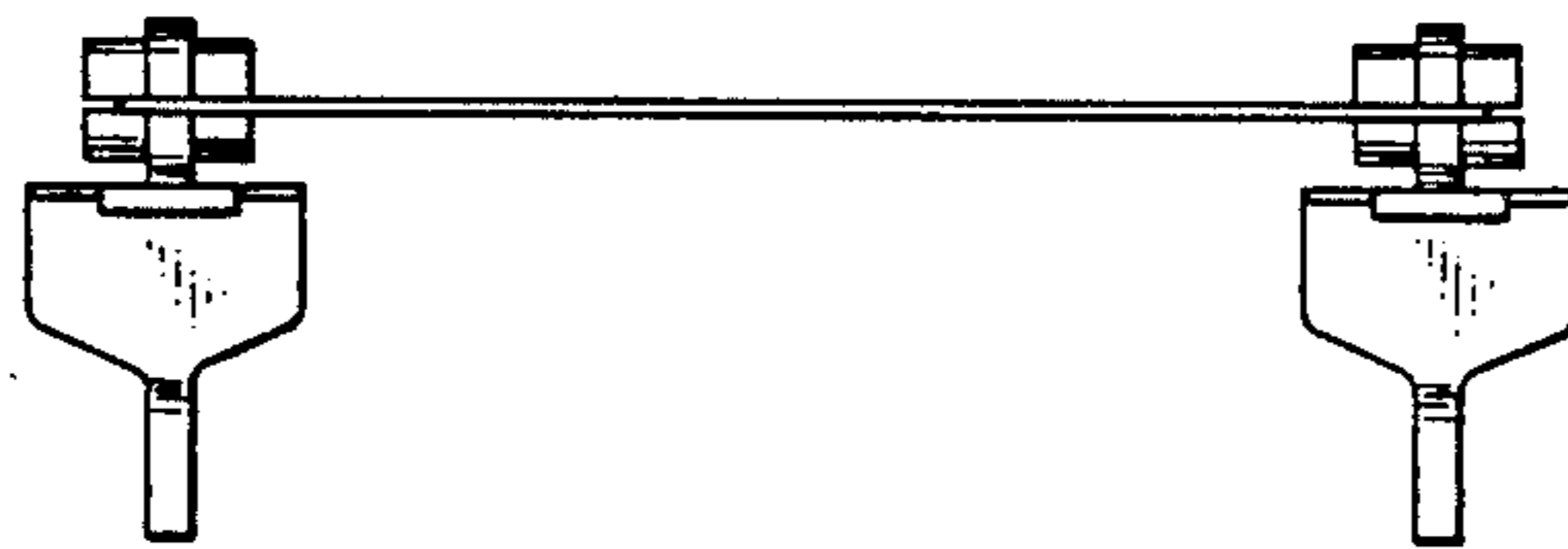

FIG. 4

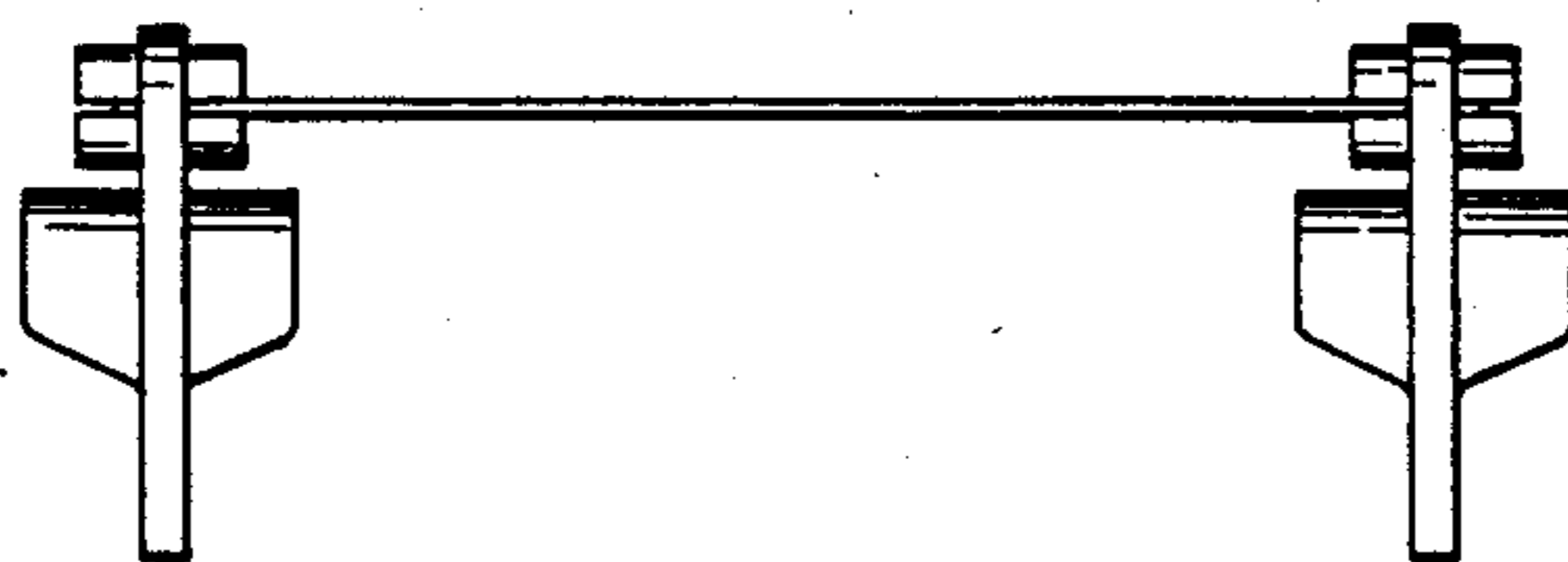

FIG. 5

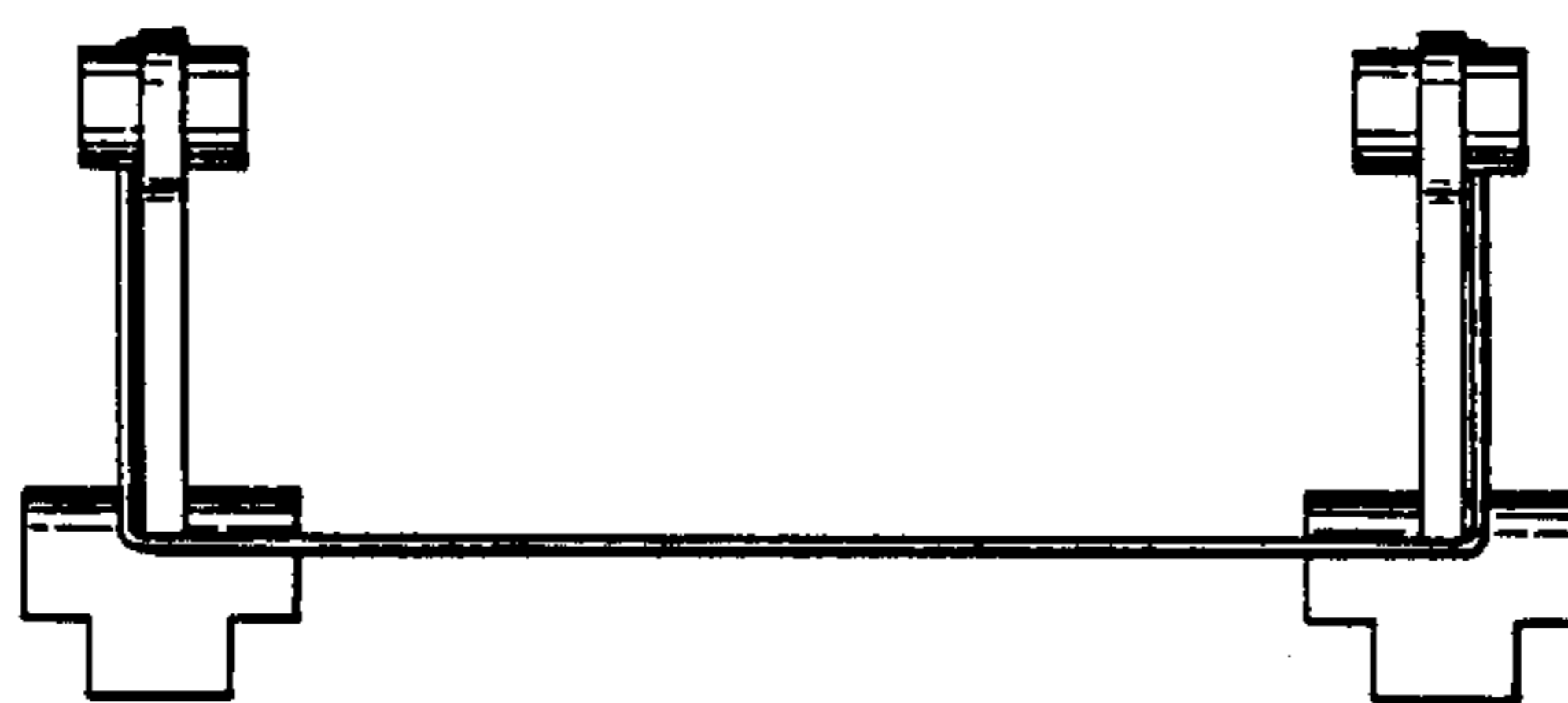
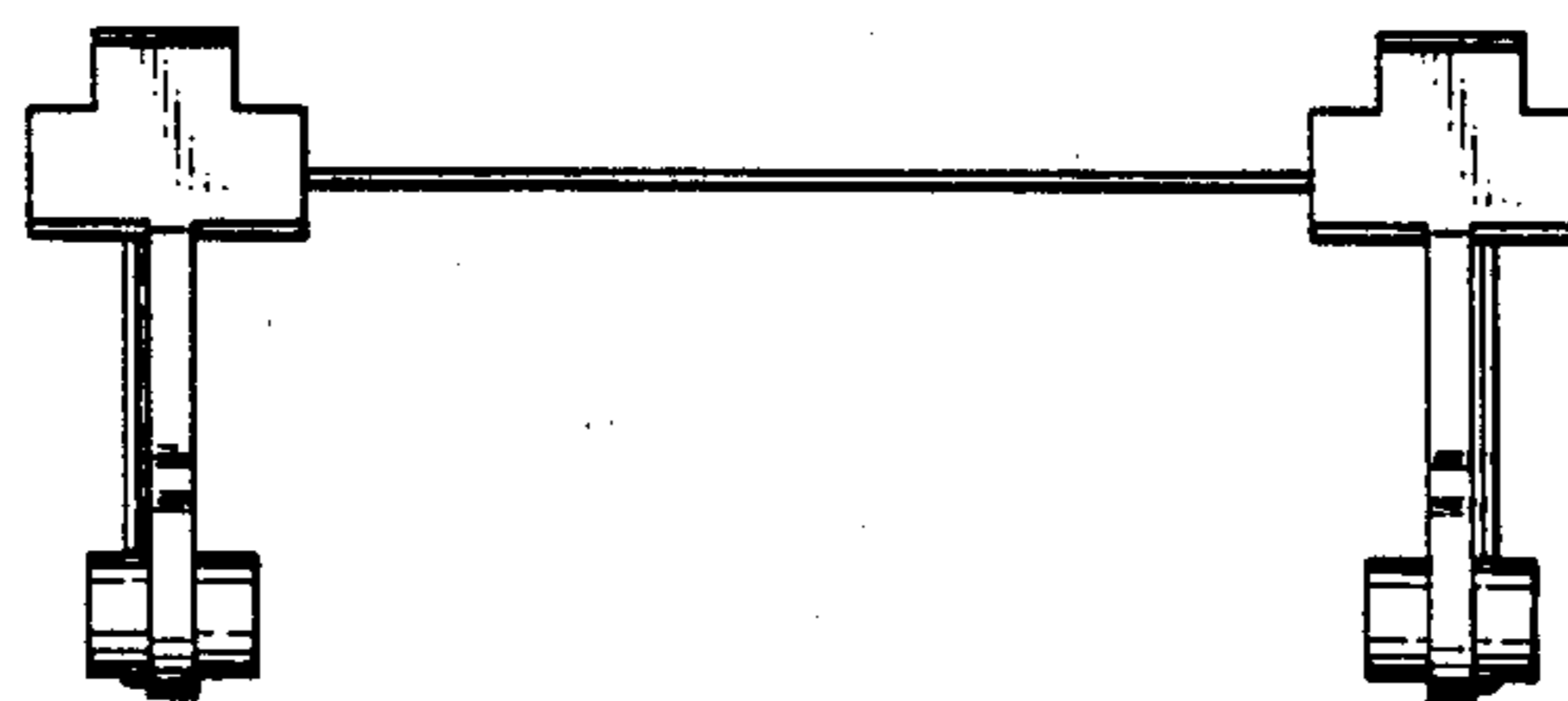

FIG. 6



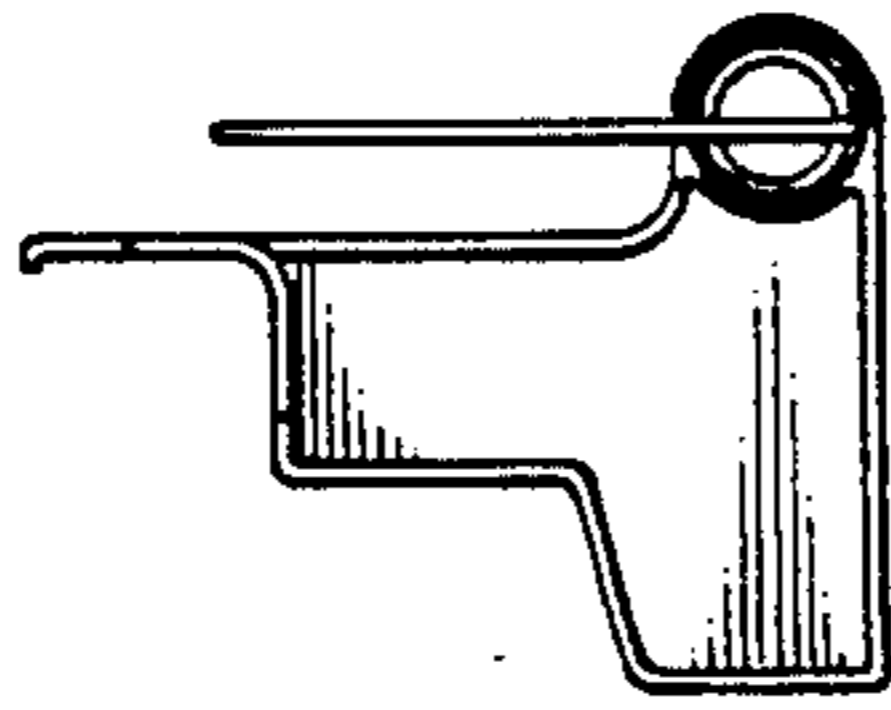

FIG. 7