

[54] **COMPUTER WORKSTATION UNIT**

[75] **Inventor: William J. Dickson, Toronto, Canada**

[73] **Assignee: Jamie Dickson Design Inc., Toronto, Canada**

[**] **Term: 14 Years**

[21] **Appl. No.: 2,499**

[22] **Filed: Jan. 9, 1987**

Related U.S. Application Data

[62] **Division of Ser. No. 633,527, Jul. 23, 1984, Pat. No. Des. 289,114.**

[30] **Foreign Application Priority Data**

Apr. 12, 1984 [CA] Canada 12-04-84-10
[52] **U.S. Cl. D6/421; D6/425; D6/440; D6/470**
[58] **Field of Search D6/421, 425, 429, 430, D6/431, 440, 470, 471, 426, 428; 312/194, 195, 196**

[56] **References Cited**

U.S. PATENT DOCUMENTS

| | | | |
|------------|--------|----------------------|----------|
| D. 228,051 | 8/1973 | Shimaoka et al. | D6/421 |
| D. 243,300 | 2/1977 | Christensen | D6/421 |
| D. 247,274 | 2/1978 | McKinnon | D6/421 X |
| D. 267,458 | 1/1983 | McKinnon | D6/421 X |
| D. 284,146 | 6/1986 | Gordon | D6/425 |
| D. 289,715 | 5/1987 | Kirch | D6/425 |

Primary Examiner—Carmen H. Vales

[57] **CLAIM**

The ornamental design for a computer workstation unit, as shown and described.

DESCRIPTION

FIG. 1 is a front perspective view of a computer workstation unit showing my new design;
FIG. 2 is a rear perspective view thereof;
FIG. 3 is a left side elevational view thereof;
FIG. 4 is a front elevational view thereof;
FIG. 5 is a right side elevational view thereof;
FIG. 6 is a front perspective view with the cover in open position;
FIG. 7 is a rear perspective view thereof;
FIG. 8 is a left side elevational view thereof;
FIG. 9 is a front elevational view thereof; and
FIG. 10 is a right side elevational view thereof.

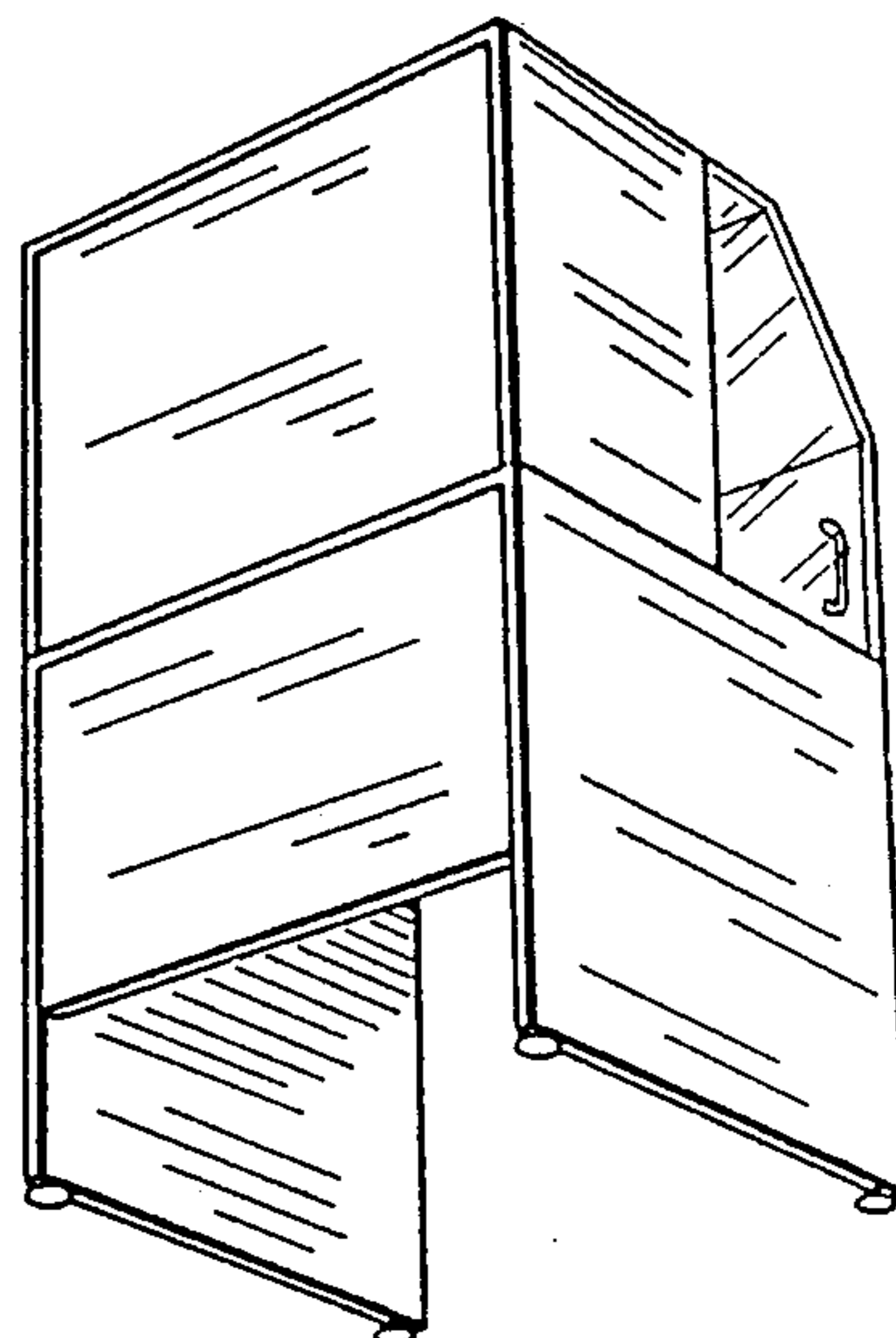
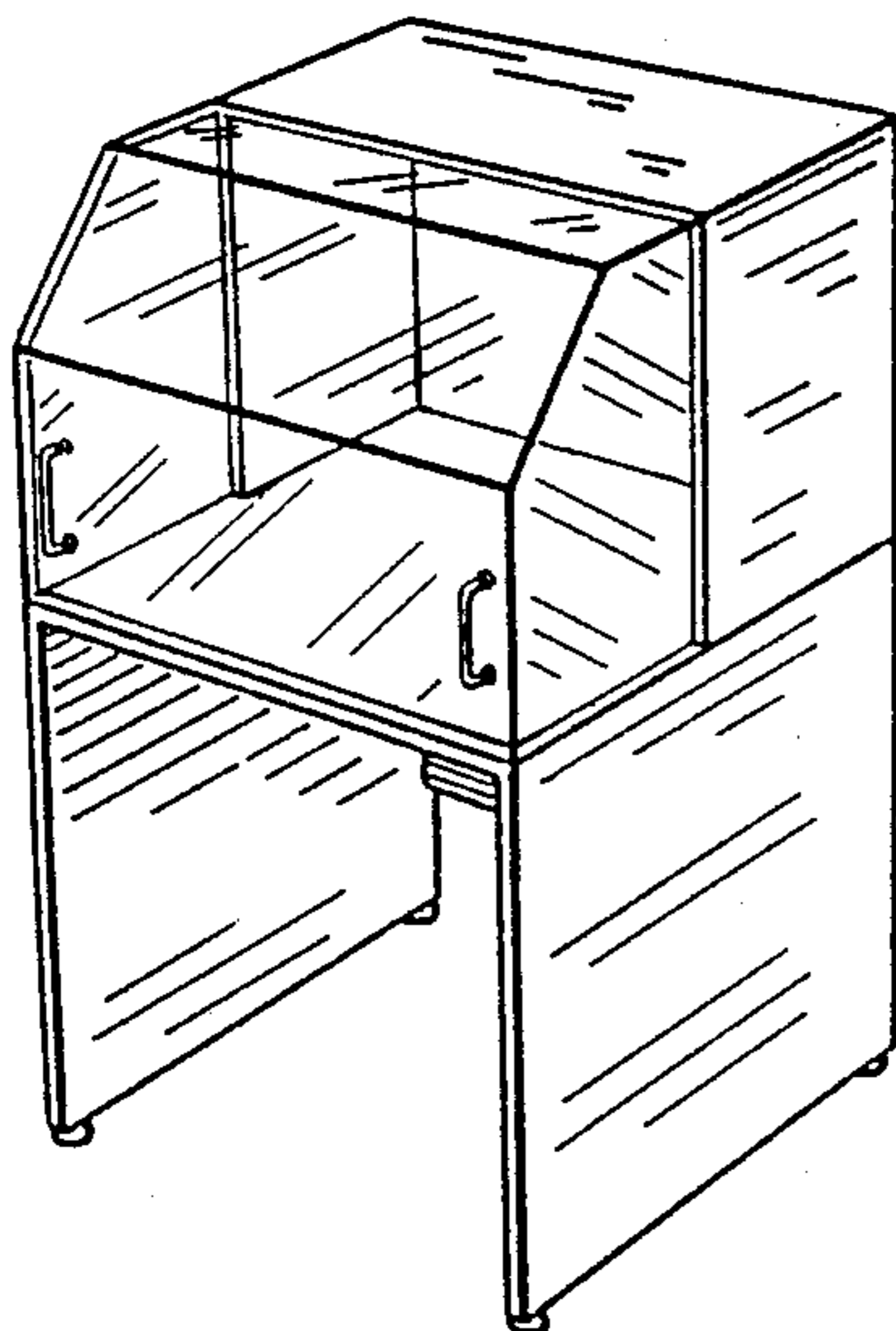

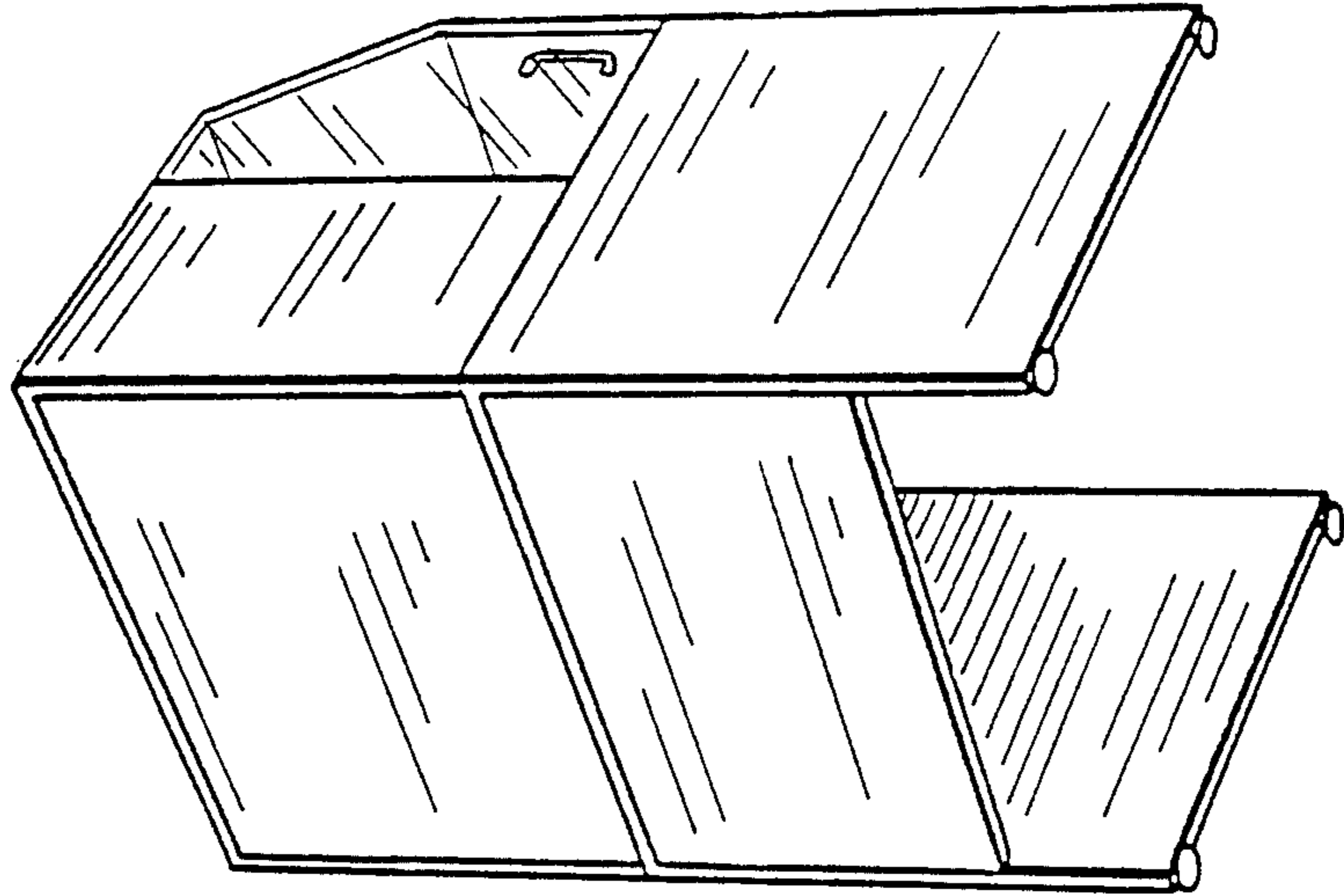

FIG. 2

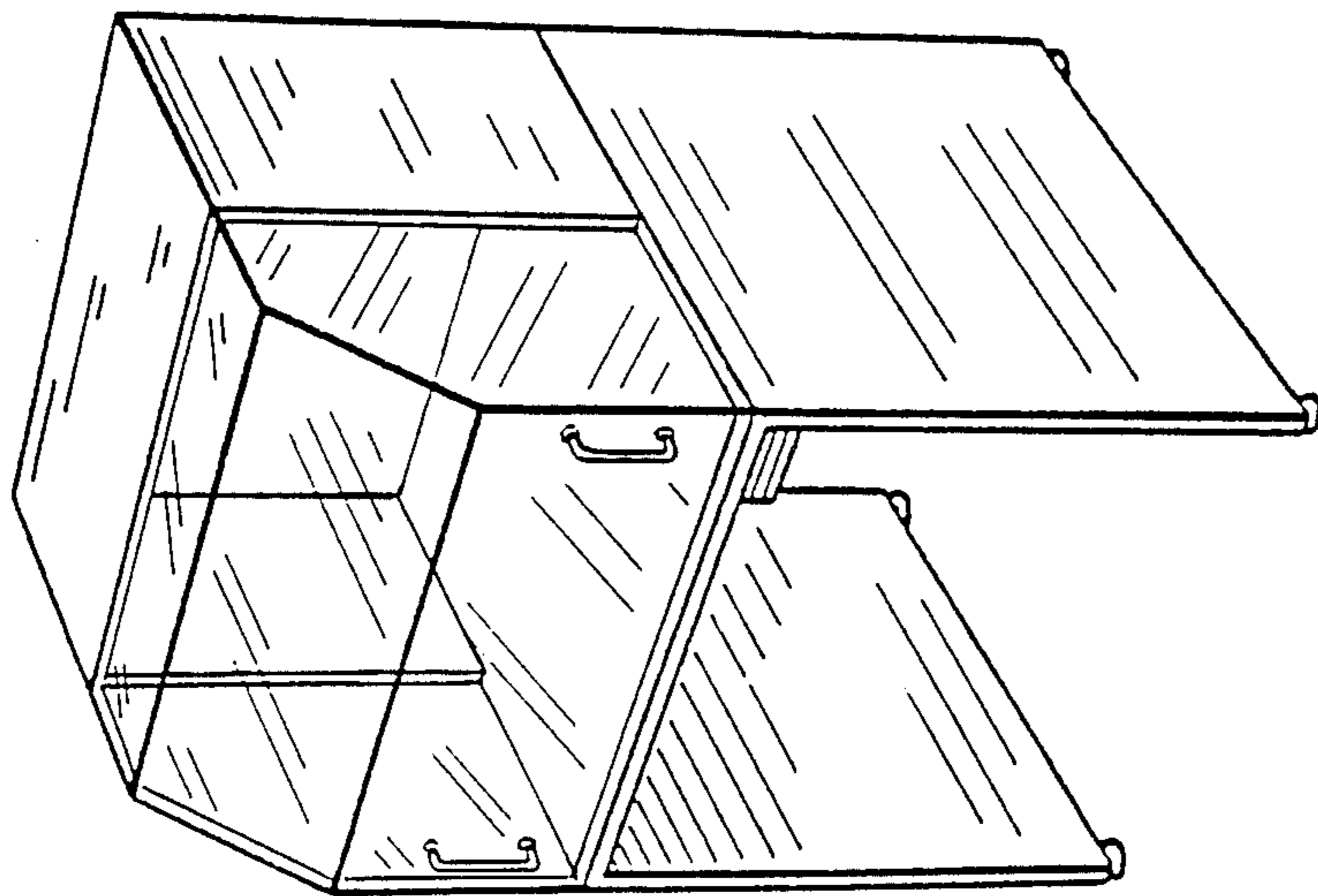

FIG. 1

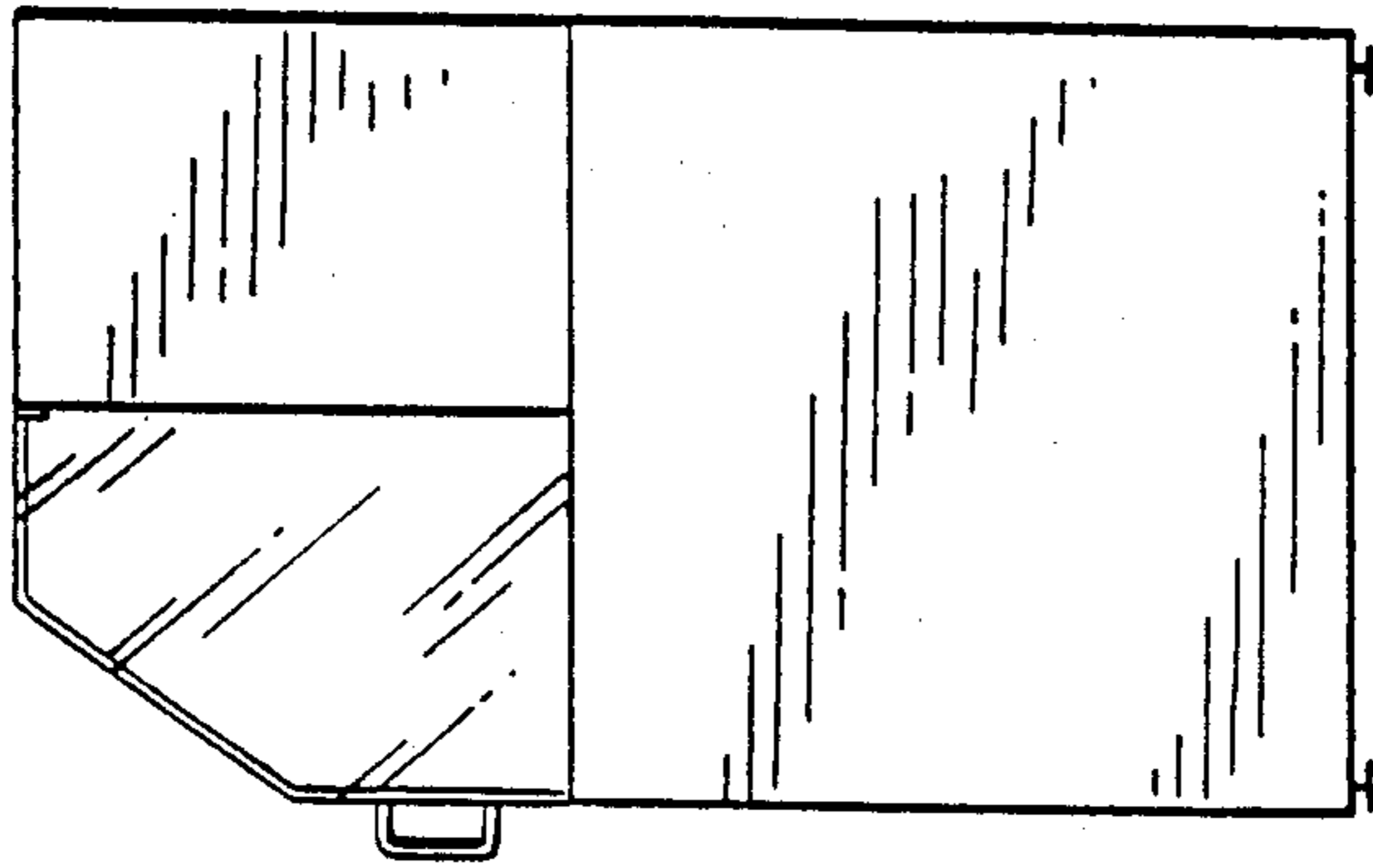

FIG.5

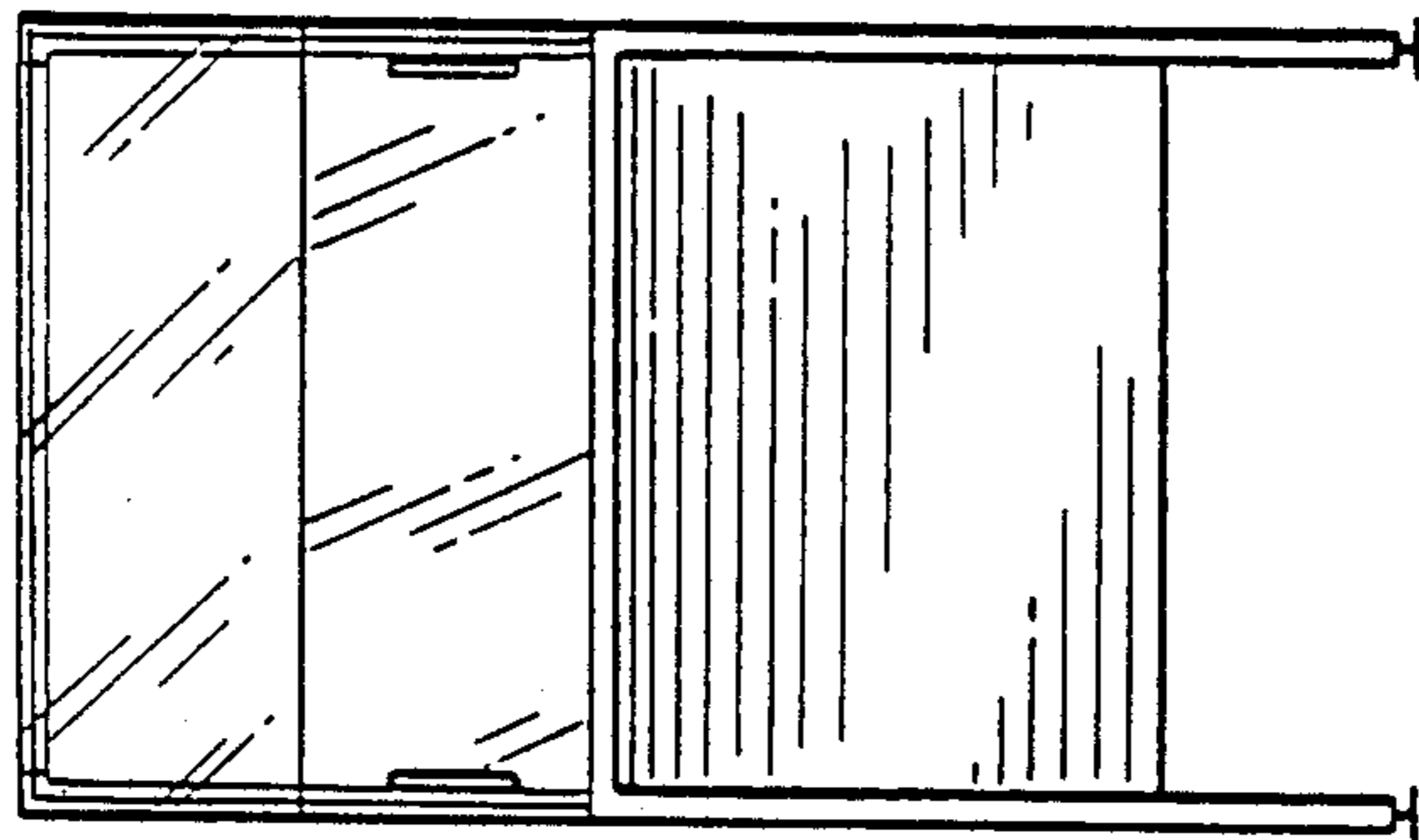

FIG.4

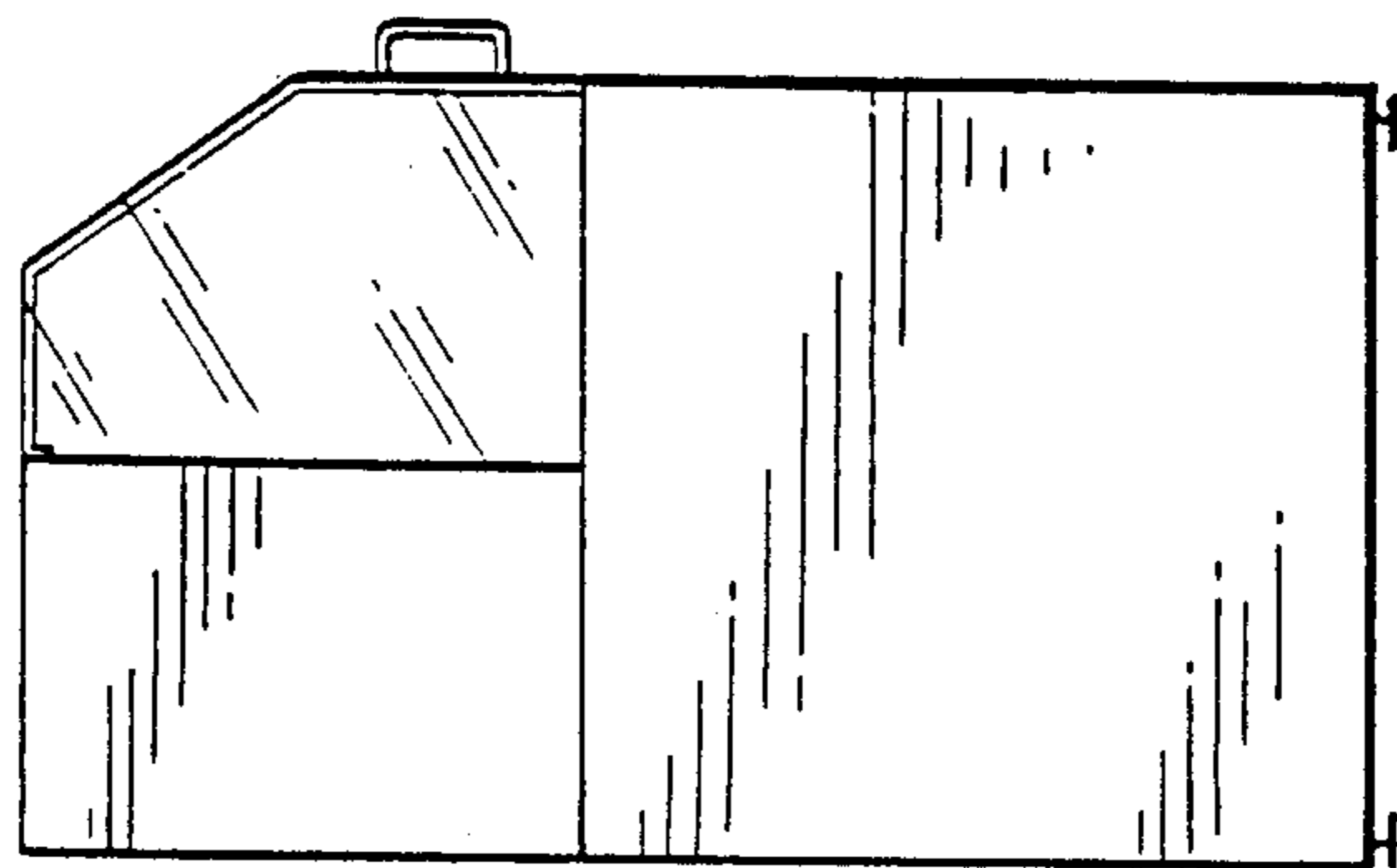
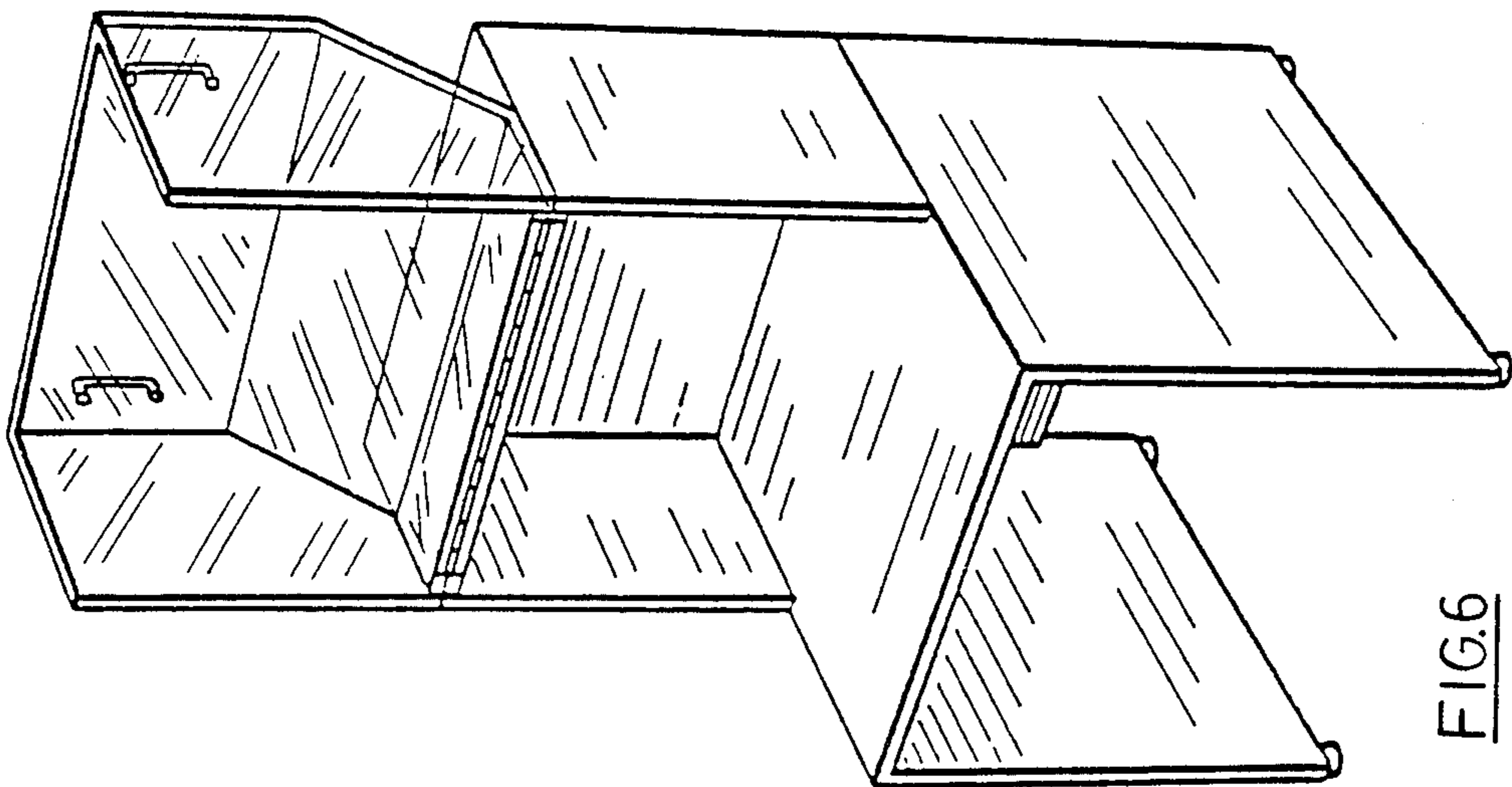
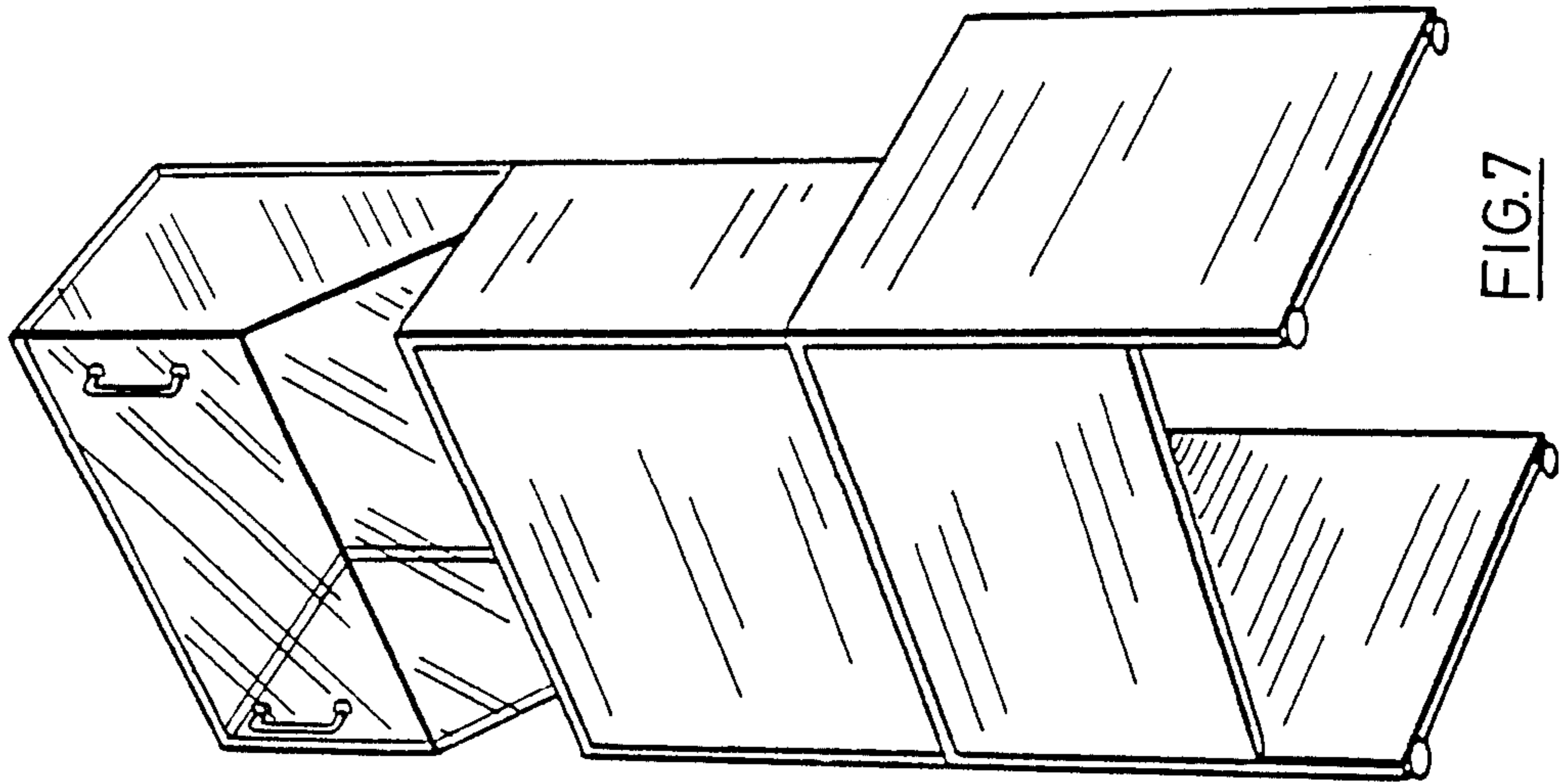

FIG.3



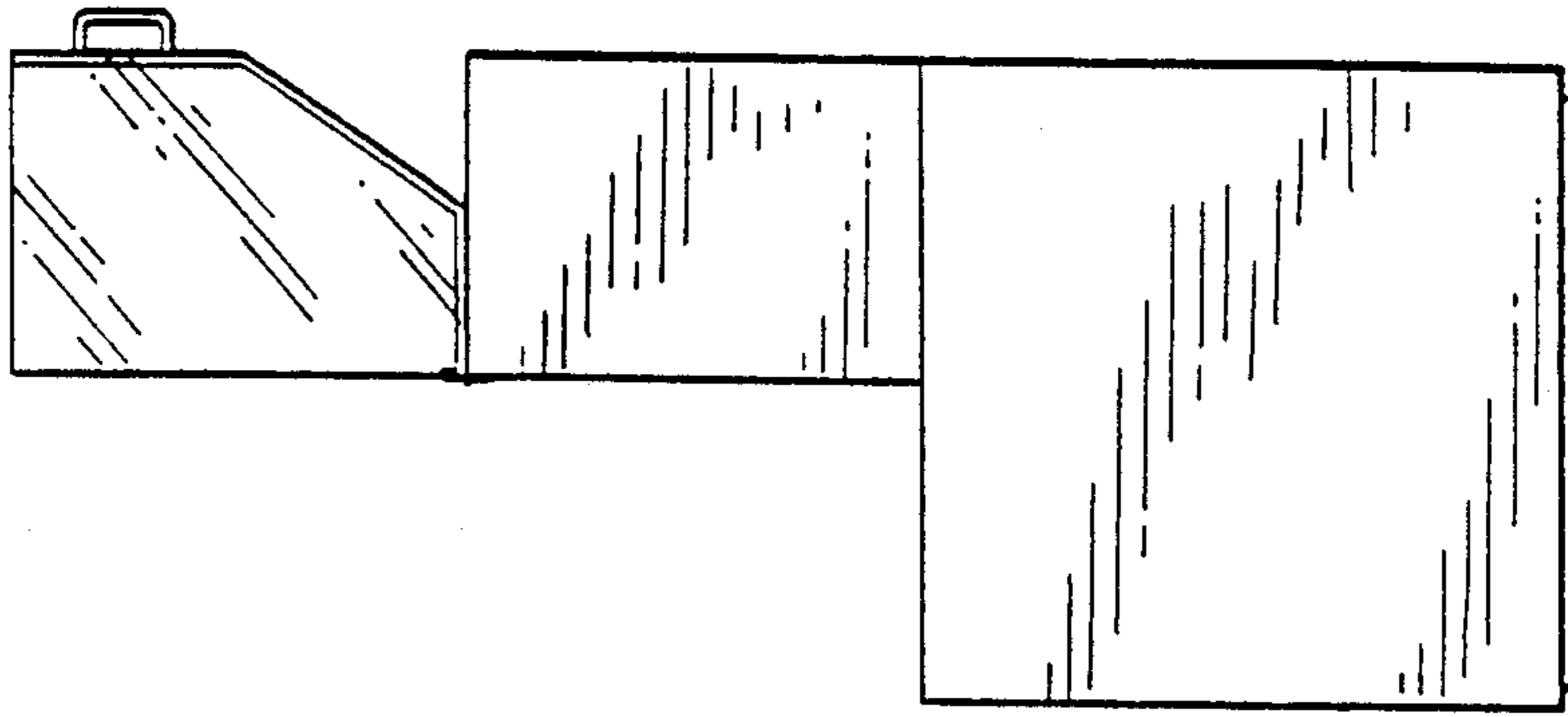

FIG. 10

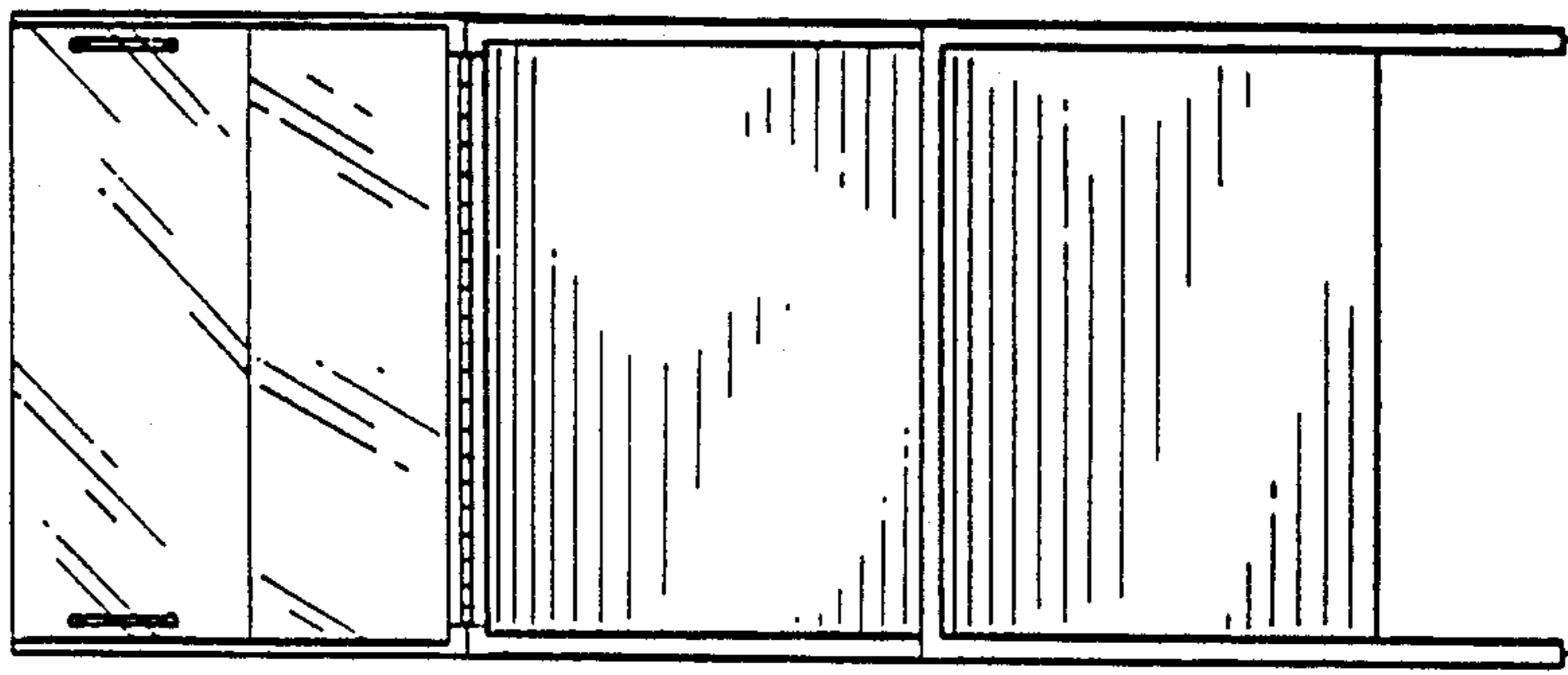

FIG. 9

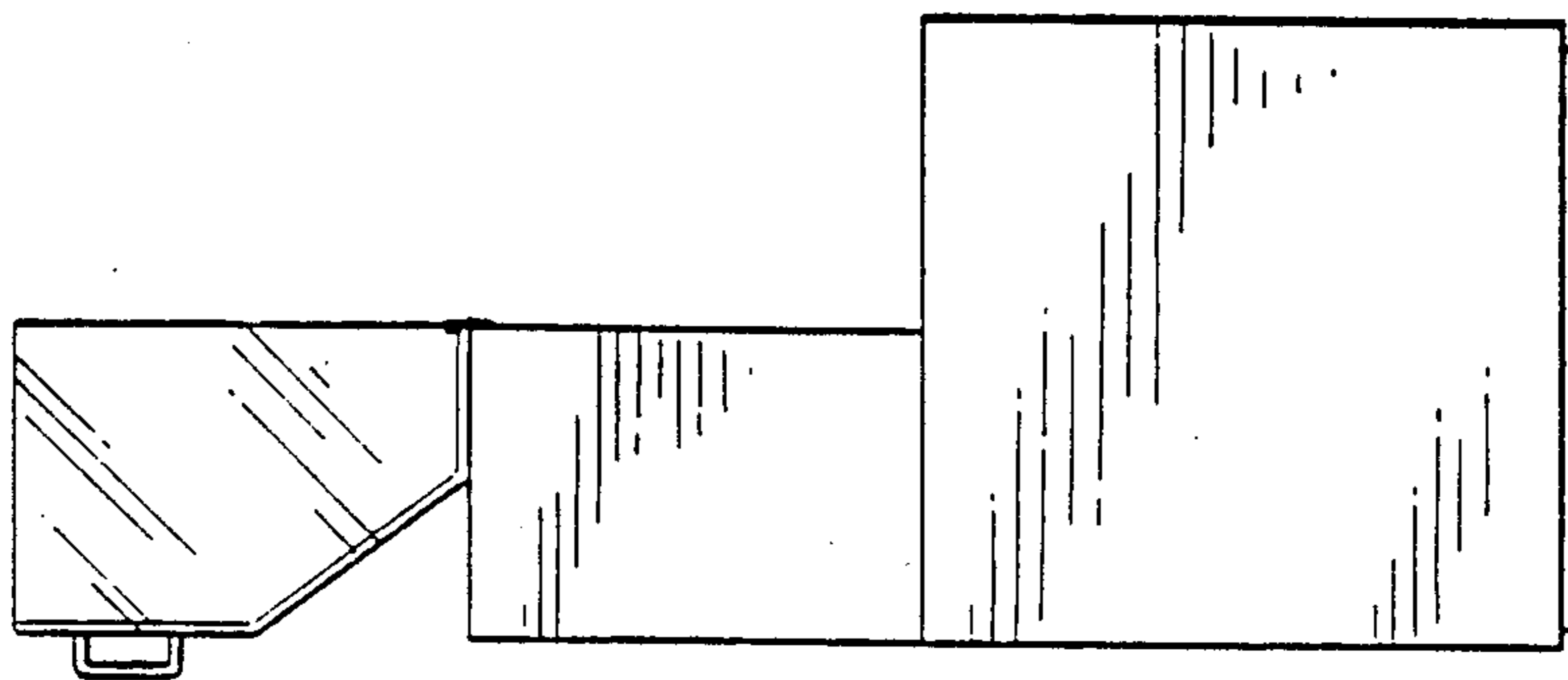

FIG. 8