

[54] HAIR DRYER CASING

[75] Inventors: Kazuyoshi Yonezawa, Kadoma, Japan; Florian Seiffert, Wiesbaden, Fed. Rep. of Germany

[73] Assignee: Matsushita Electric Works, Ltd., Japan

[**] Term: 14 Years

[21] Appl. No.: 834,441

[22] Filed: Feb. 20, 1986

[30] Foreign Application Priority Data

Aug. 24, 1984 [JP] Japan 60-35846

[52] U.S. Cl. D28/12

[58] Field of Search D28/9, 10, 12-19; 34/96-100; 219/202; 132/7, 9

[56] References Cited

U.S. PATENT DOCUMENTS

- D. 265,514 7/1982 Abe et al. D28/12
- D. 272,101 1/1984 Abe et al. D28/12
- D. 289,566 4/1987 Yonezawa et al. D28/16 X
- 4,370,544 1/1983 Fujishima et al. D28/13 X
- 4,556,782 12/1985 Fujishima et al. 34/96 X

FOREIGN PATENT DOCUMENTS

283414 7/1968 Japan .

Primary Examiner—Louis S. Zarfes
Attorney, Agent, or Firm—Stevens, Davis, Miller & Mosher

[57] CLAIM

The ornamental design for a hair dryer casing, as shown.

DESCRIPTION

FIG. 1 is a front elevational view of a hair dryer casing showing our new design;
 FIG. 2 is a rear elevational view thereof;
 FIG. 3 is a top plan view thereof;
 FIG. 4 is a bottom plan view thereof;
 FIG. 5 is a left side elevational view thereof;
 FIG. 6 is a right side elevational view thereof;
 FIG. 7 is a transverse section taken on line A—A' of FIG. 1;
 FIG. 8 is a transverse section taken on line B—B' of FIG. 1;
 FIG. 9 is a transverse section taken on line C—C' of FIG. 5.

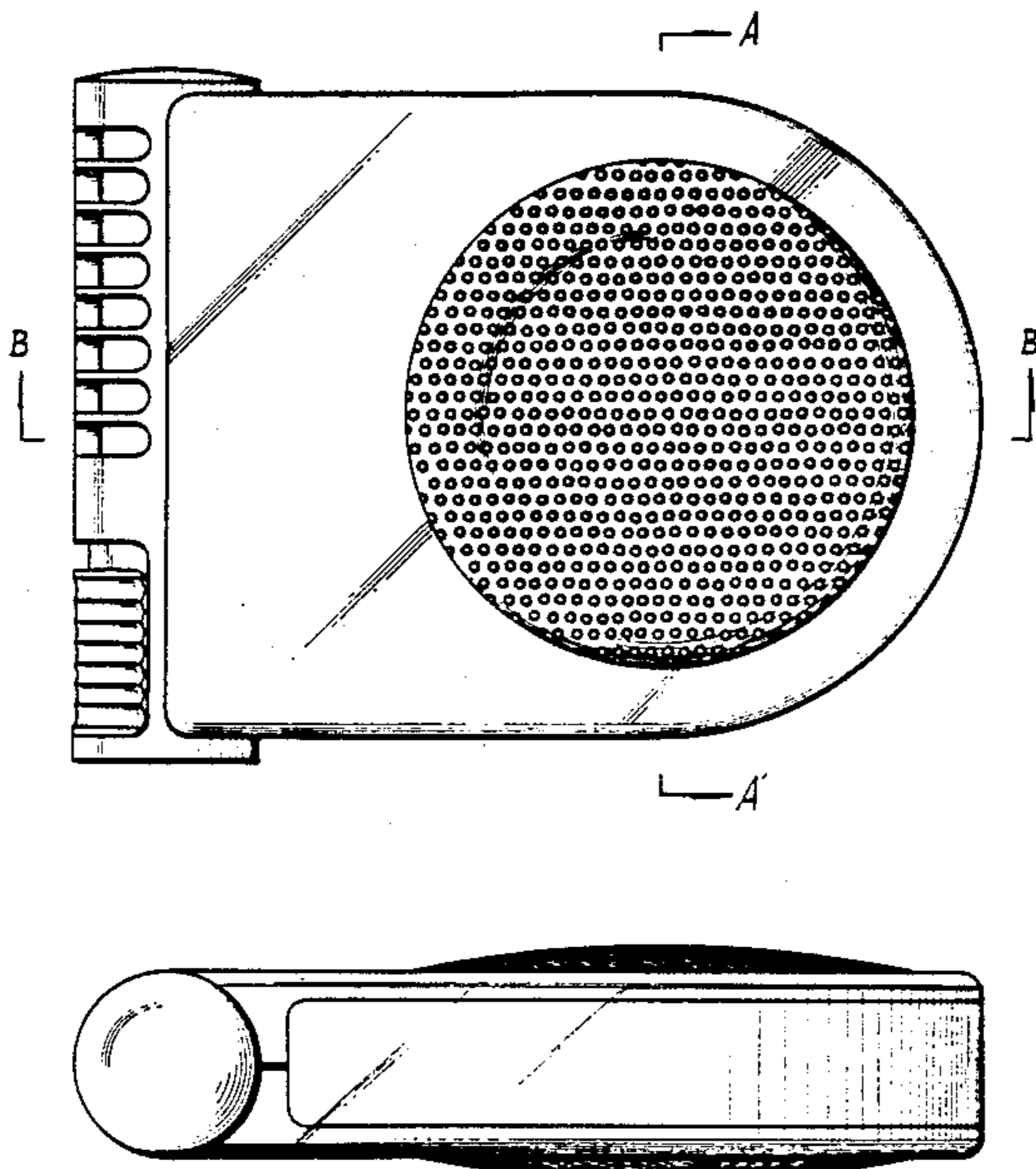

Fig 1

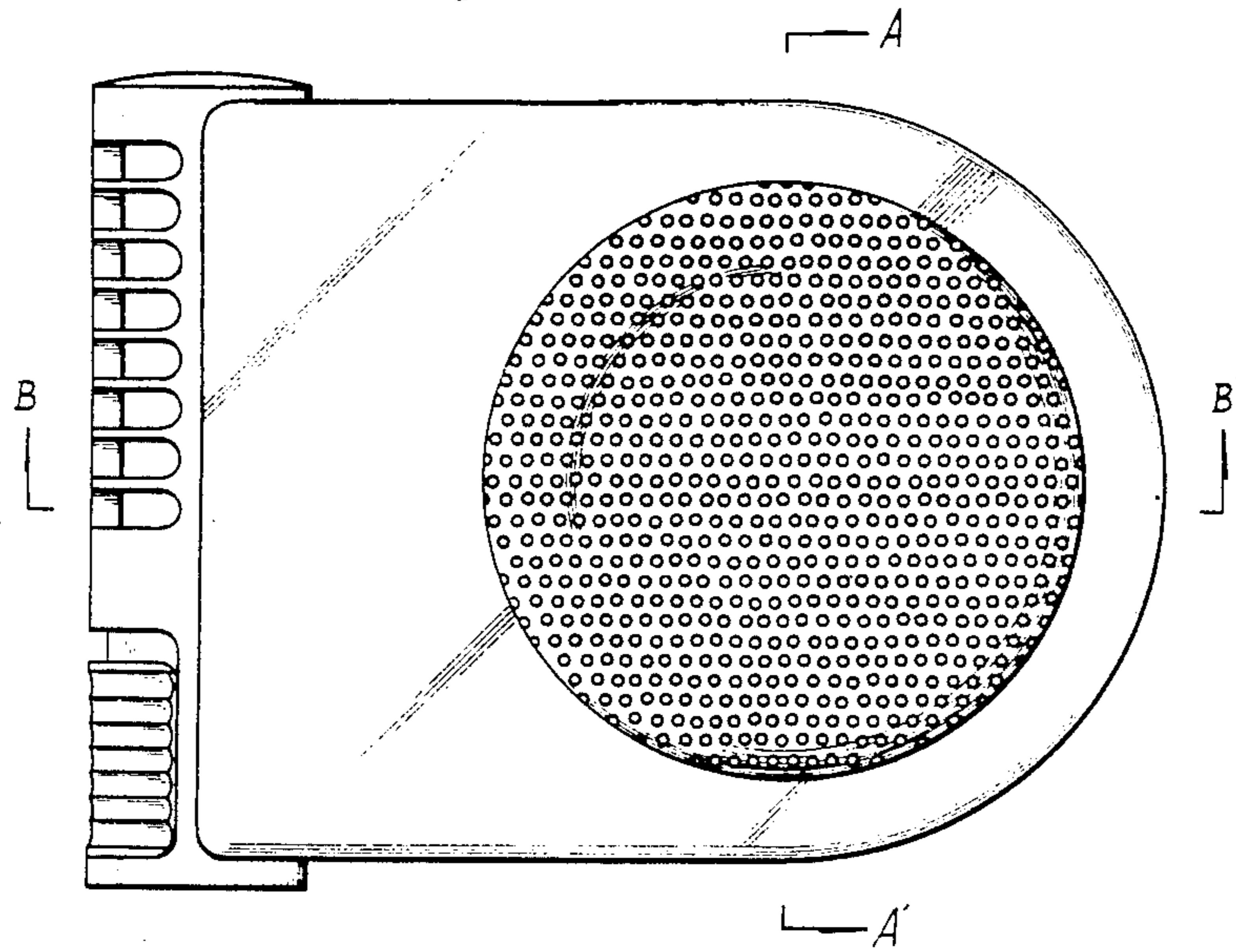

Fig 3

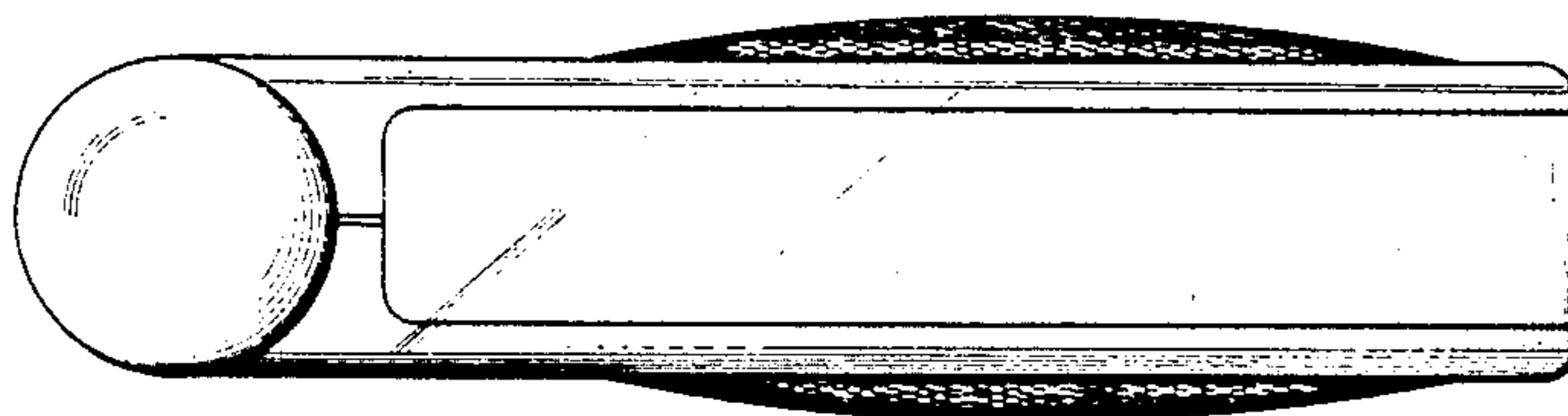

Fig 4

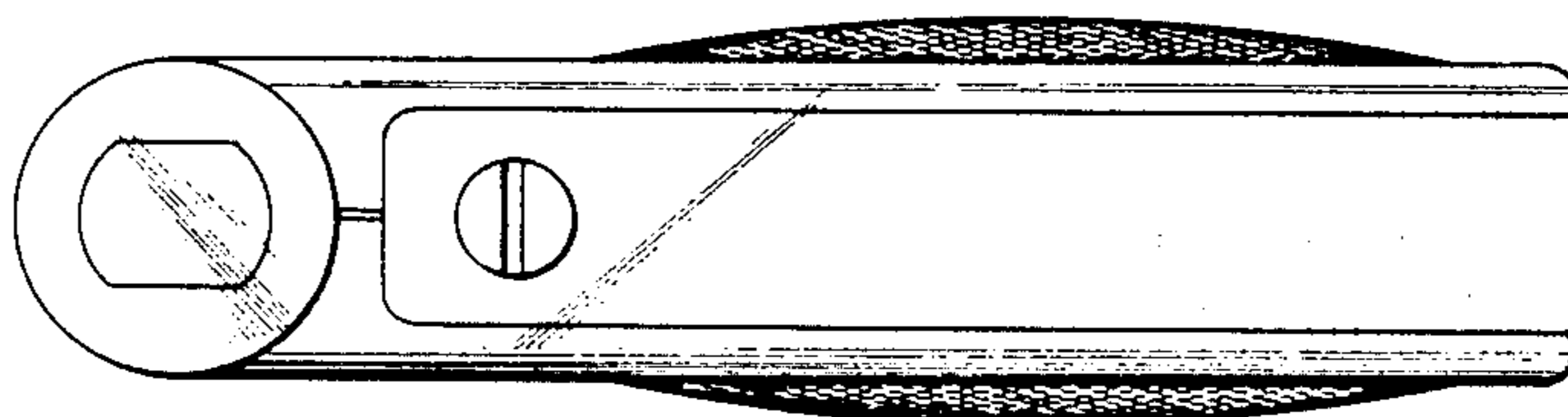

Fig 2

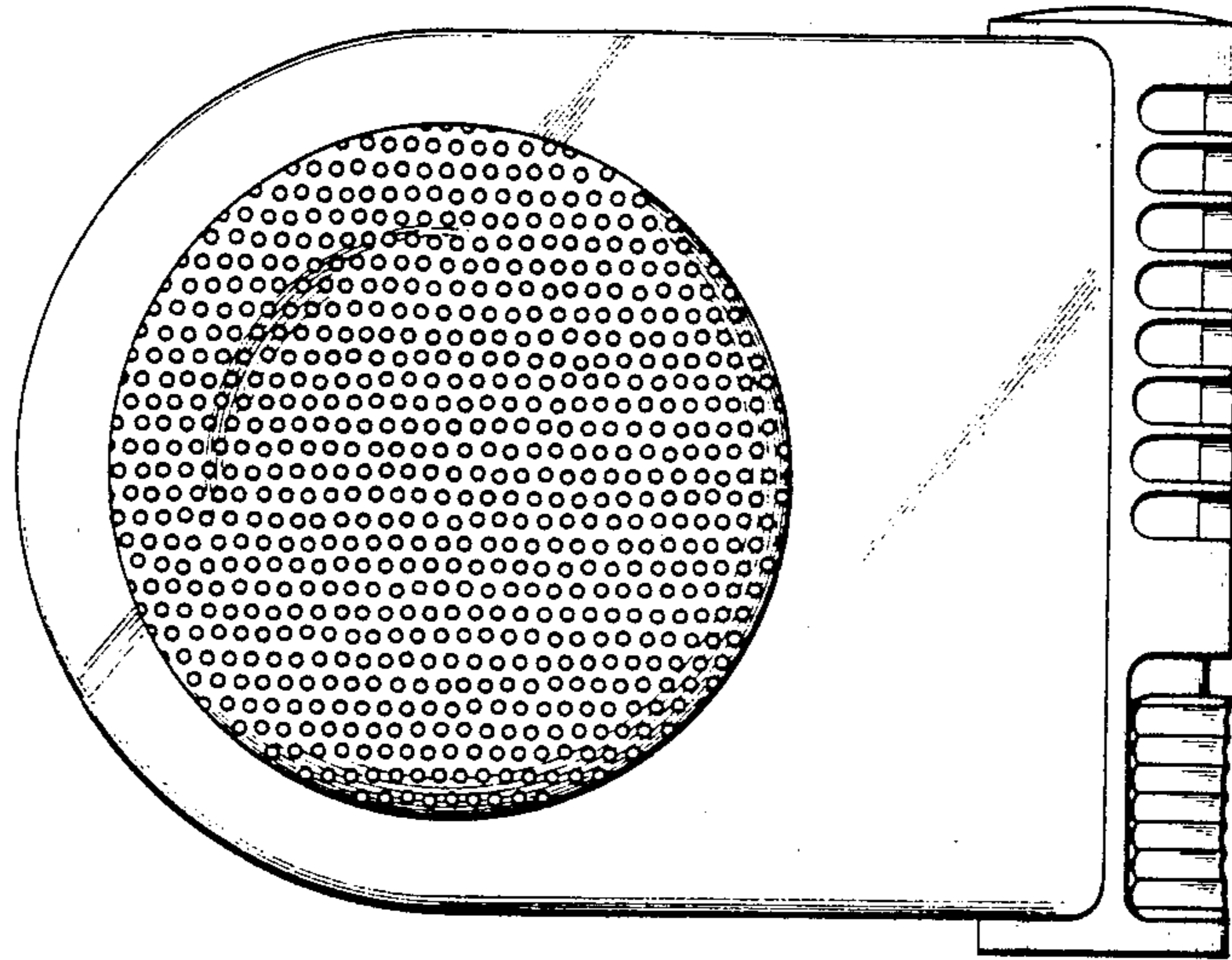
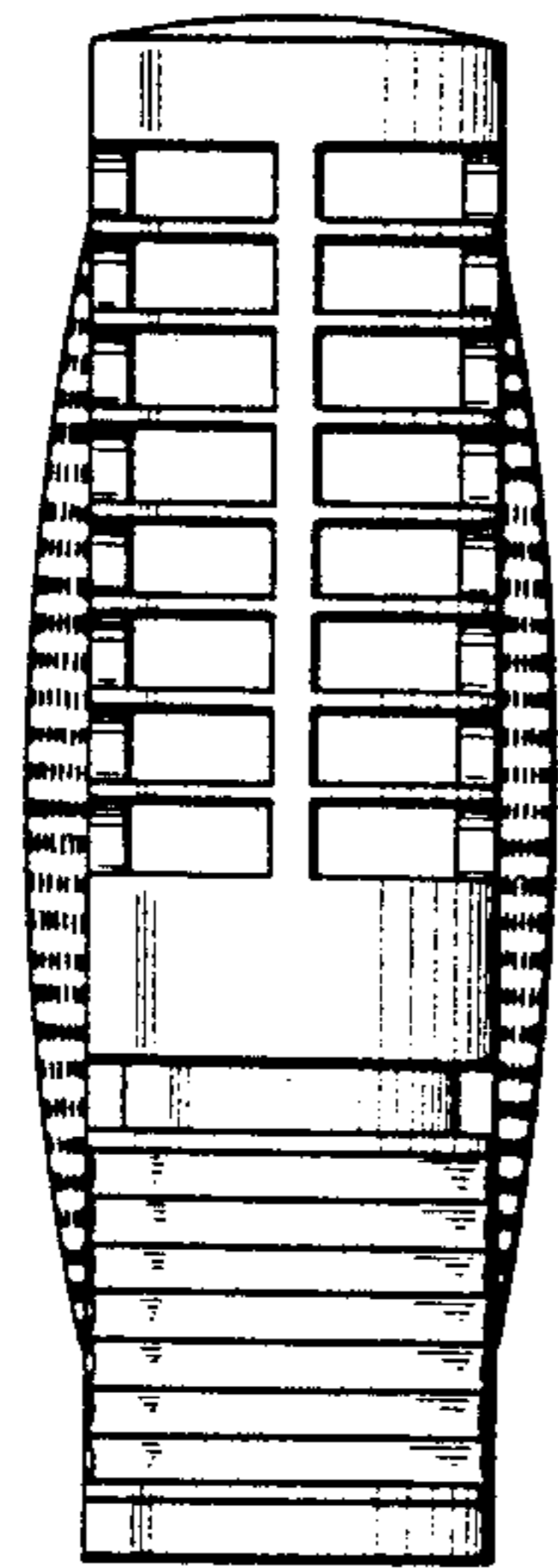

Fig 5

C —



C —

Fig 6

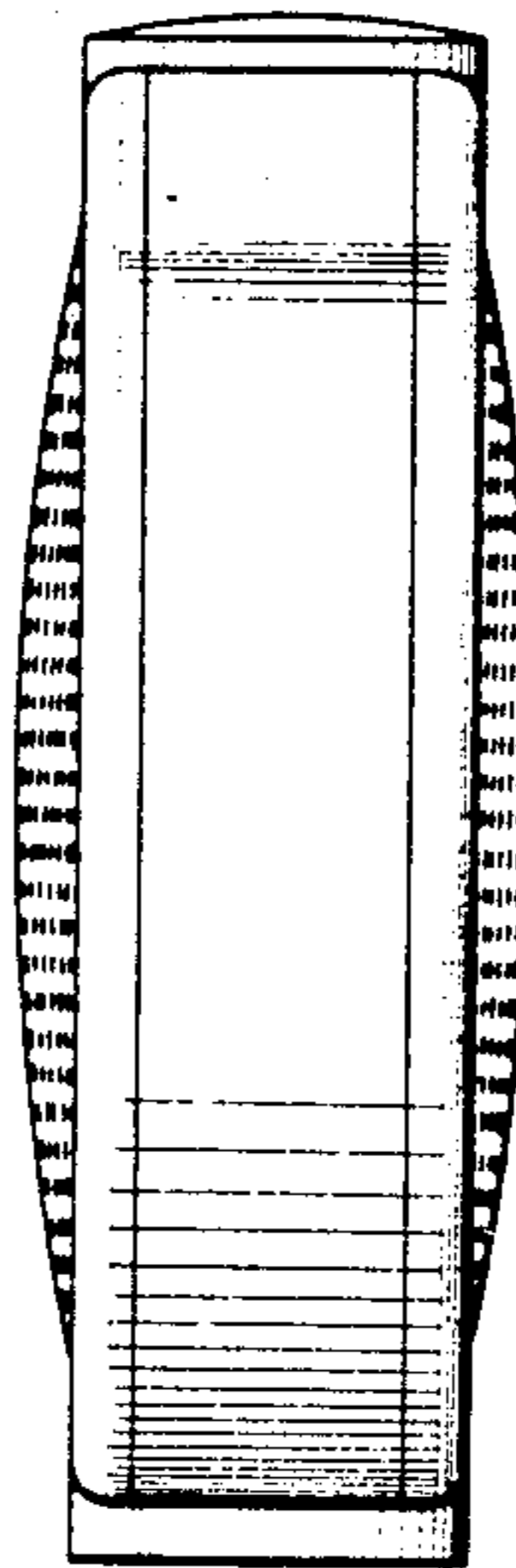

Fig 7

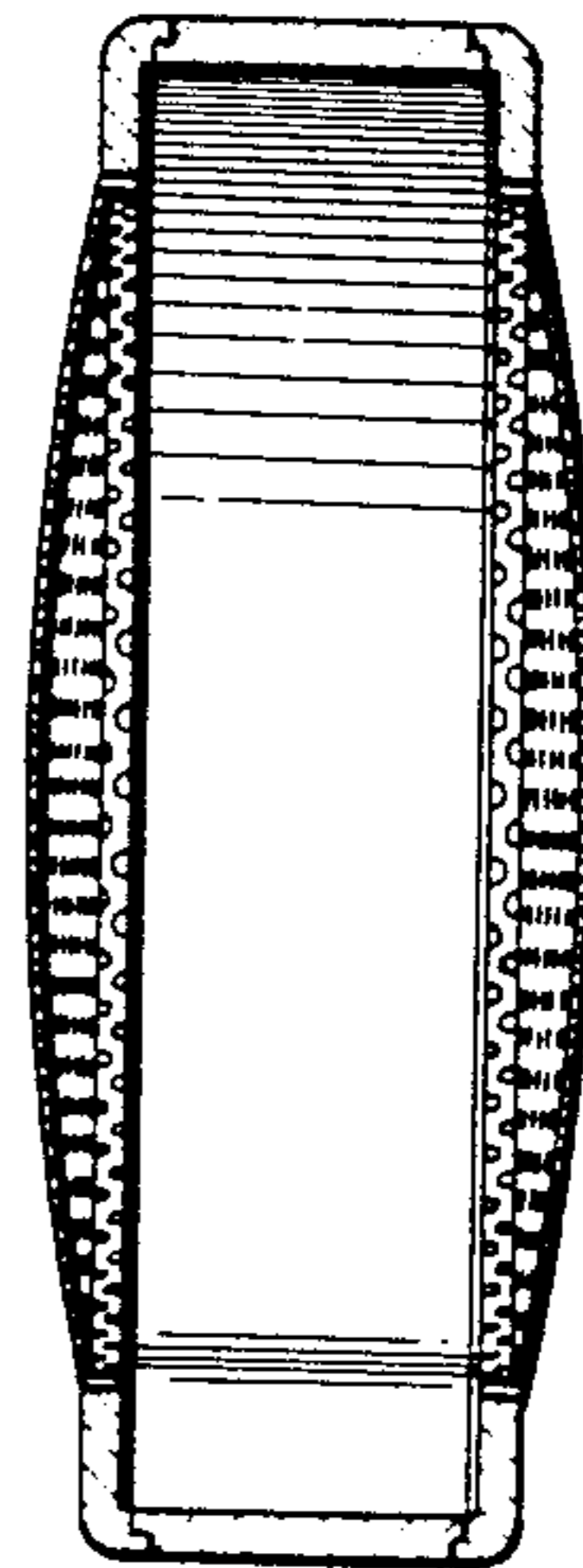

Fig 8

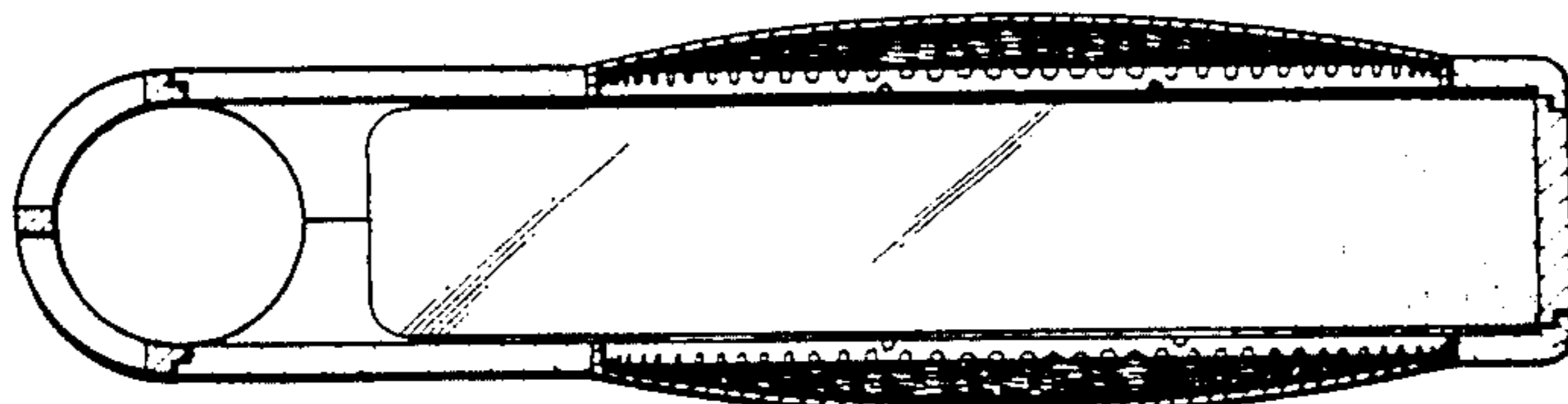

Fig 9

