

[54] CASH DRAWER FOR AN ELECTRONIC CASH REGISTER

D. 278,542 4/1985 Kakiuchi et al. .... D18/4  
D. 283,822 5/1986 Ishida ..... D18/4  
4,328,544 5/1982 Baldwin et al. .... 364/900

[75] Inventor: Roger C. Williams, Raleigh, N.C.

Primary Examiner—Susan J. Lucas  
Assistant Examiner—Ruth Takemoto  
Attorney, Agent, or Firm—Joscelyn G. Cockburn

[73] Assignee: International Business Machines Corp., Armonk, N.Y.

[\*\*] Term: 14 Years

[57] CLAIM

[21] Appl. No.: 777,140

The ornamental design for a cash drawer for an electronic cash register, as shown and described.

[22] Filed: Sep. 18, 1985

DESCRIPTION

[52] U.S. Cl. .... D18/4

[58] Field of Search ..... D13/12, 35, 40-41, D13/99; D18/4; 364/405, 406, 900; 361/331, 334, 380, 390; 235/379, 27 R, 2

FIG. 1 is a top, front and left side perspective view of a cash drawer for an electronic cash register showing my new design;

FIG. 2 is a front elevational view thereof;

FIG. 3 is a rear elevational view thereof;

FIG. 4 is a right side elevational view thereof;

FIG. 5 is a left side elevational view thereof;

FIG. 6 is a top plan view thereof;

FIG. 7 is a bottom plan view thereof.

[56] References Cited

U.S. PATENT DOCUMENTS

D. 220,538 4/1971 Stoltz ..... D18/4  
D. 269,441 6/1983 Matsuda et al. .... D18/4

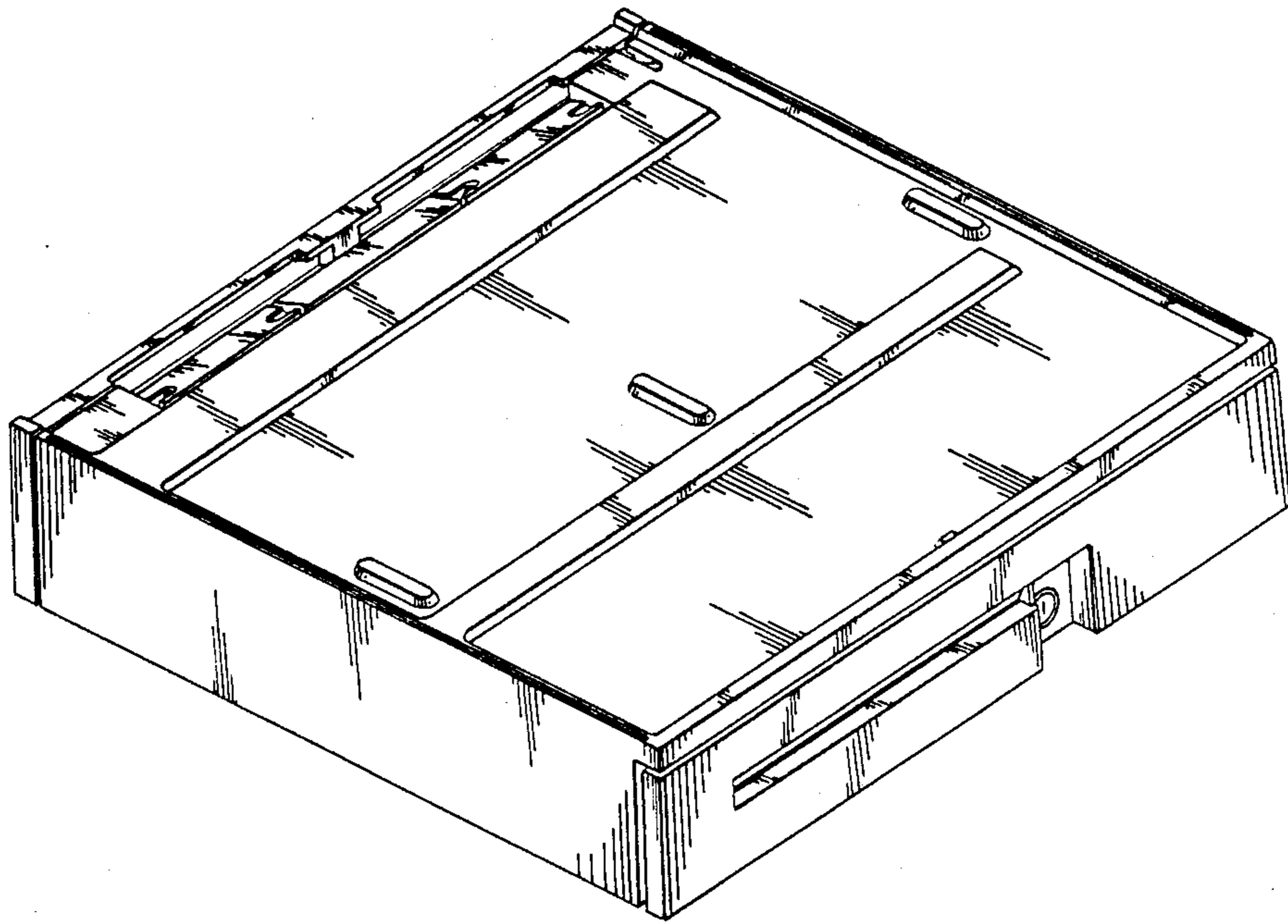

FIG. 1

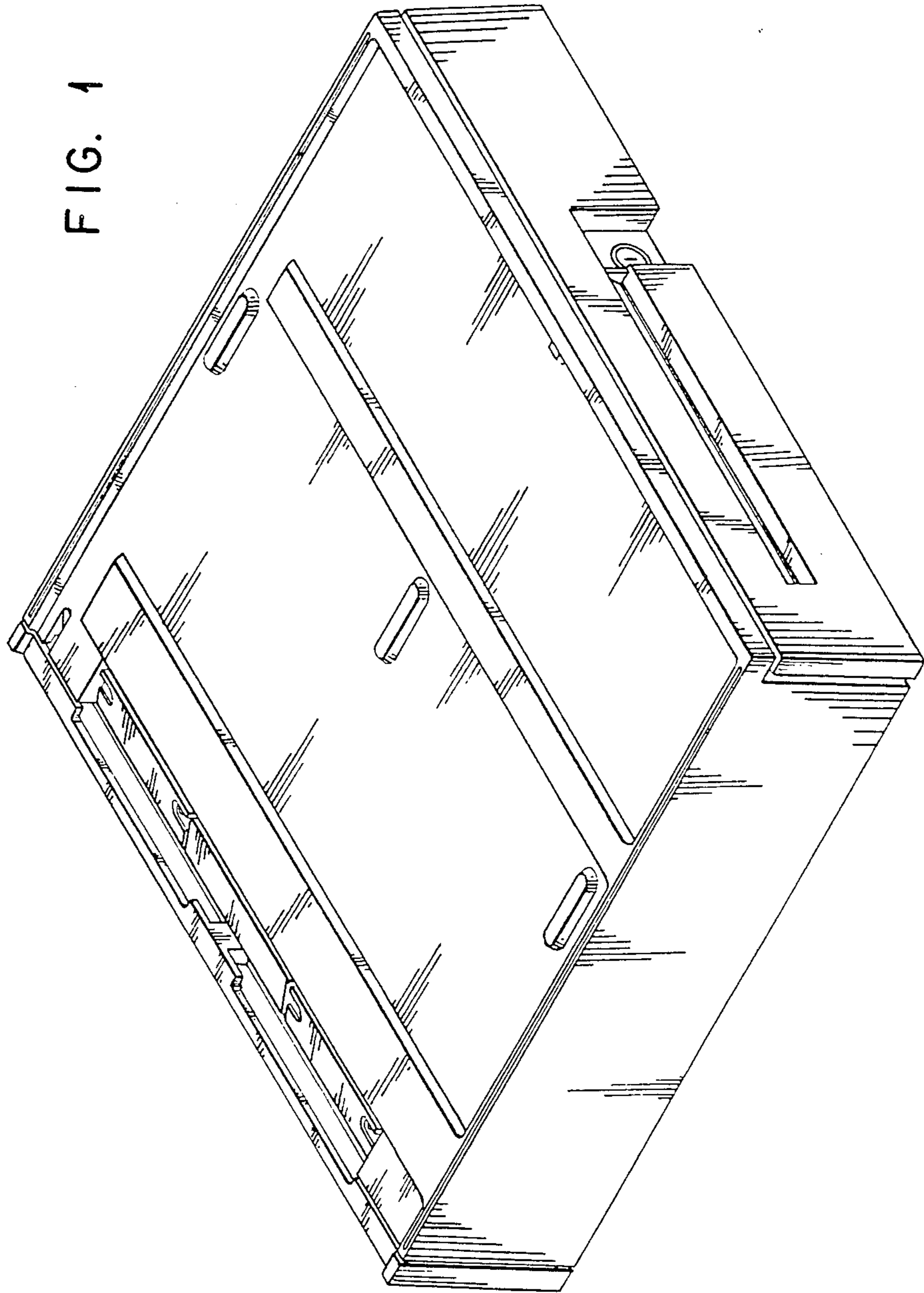

FIG. 2

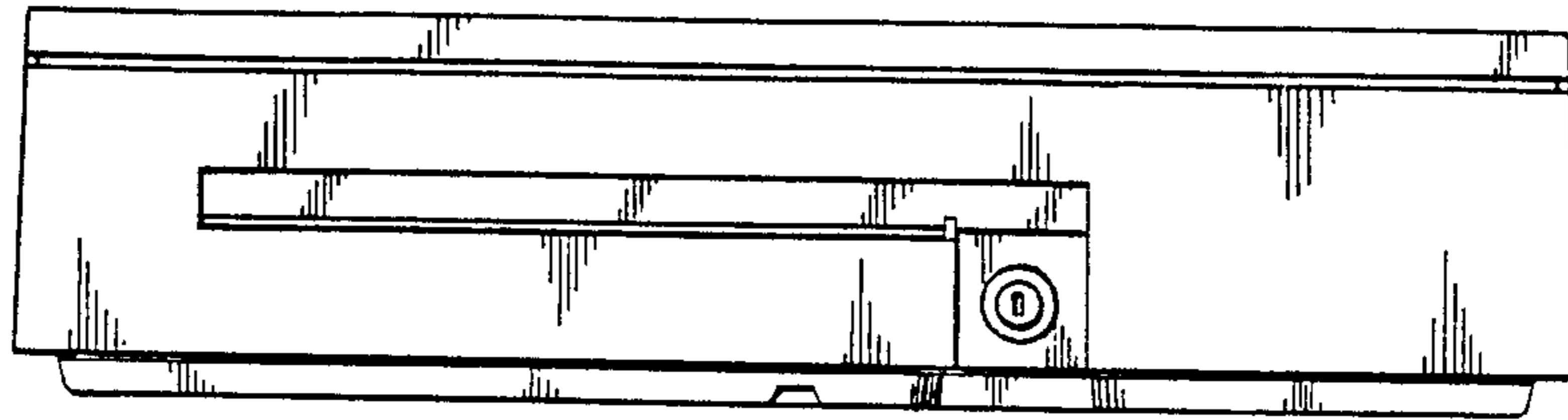

FIG. 3

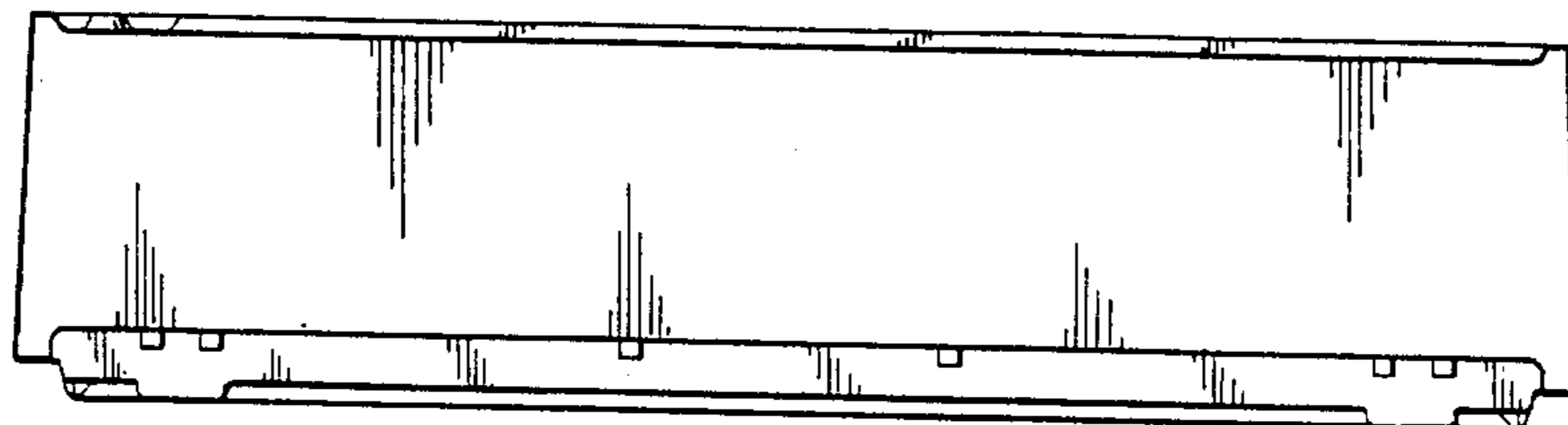

FIG. 4

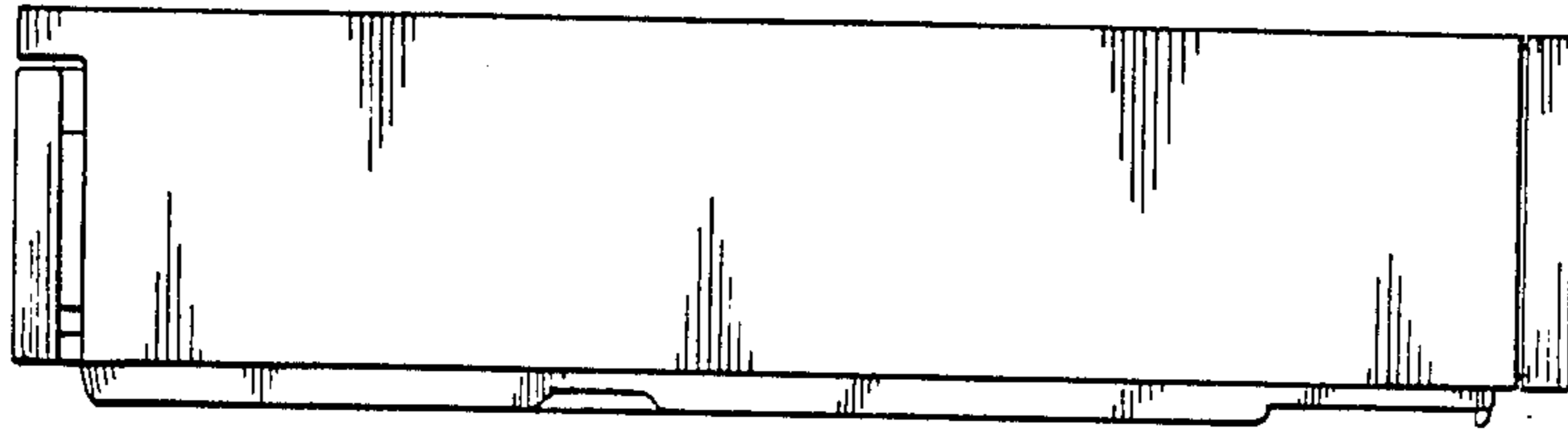

FIG. 5

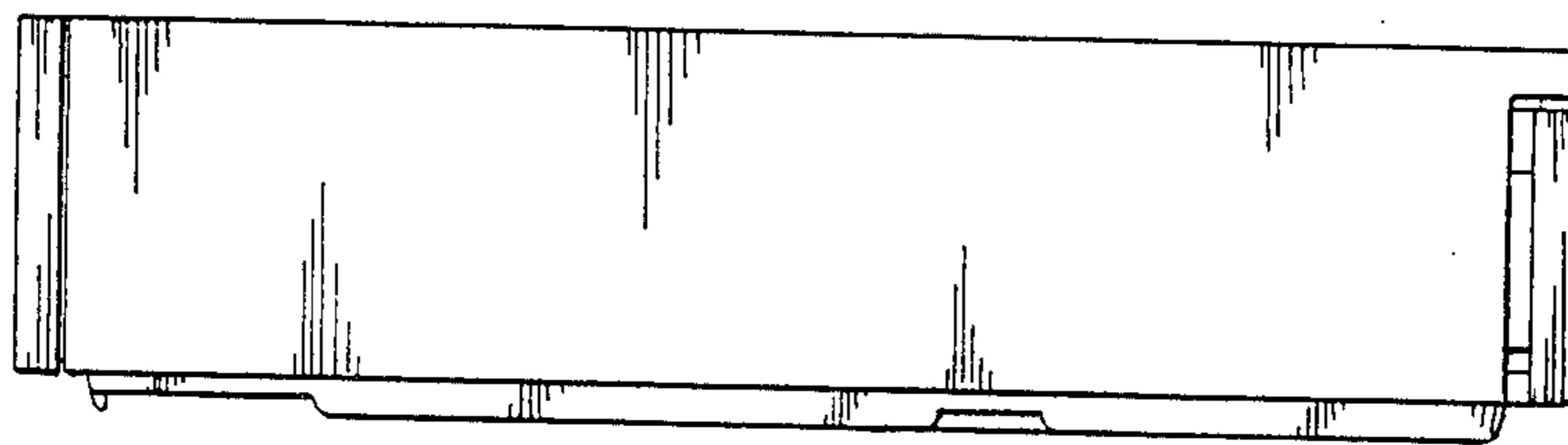

FIG. 6

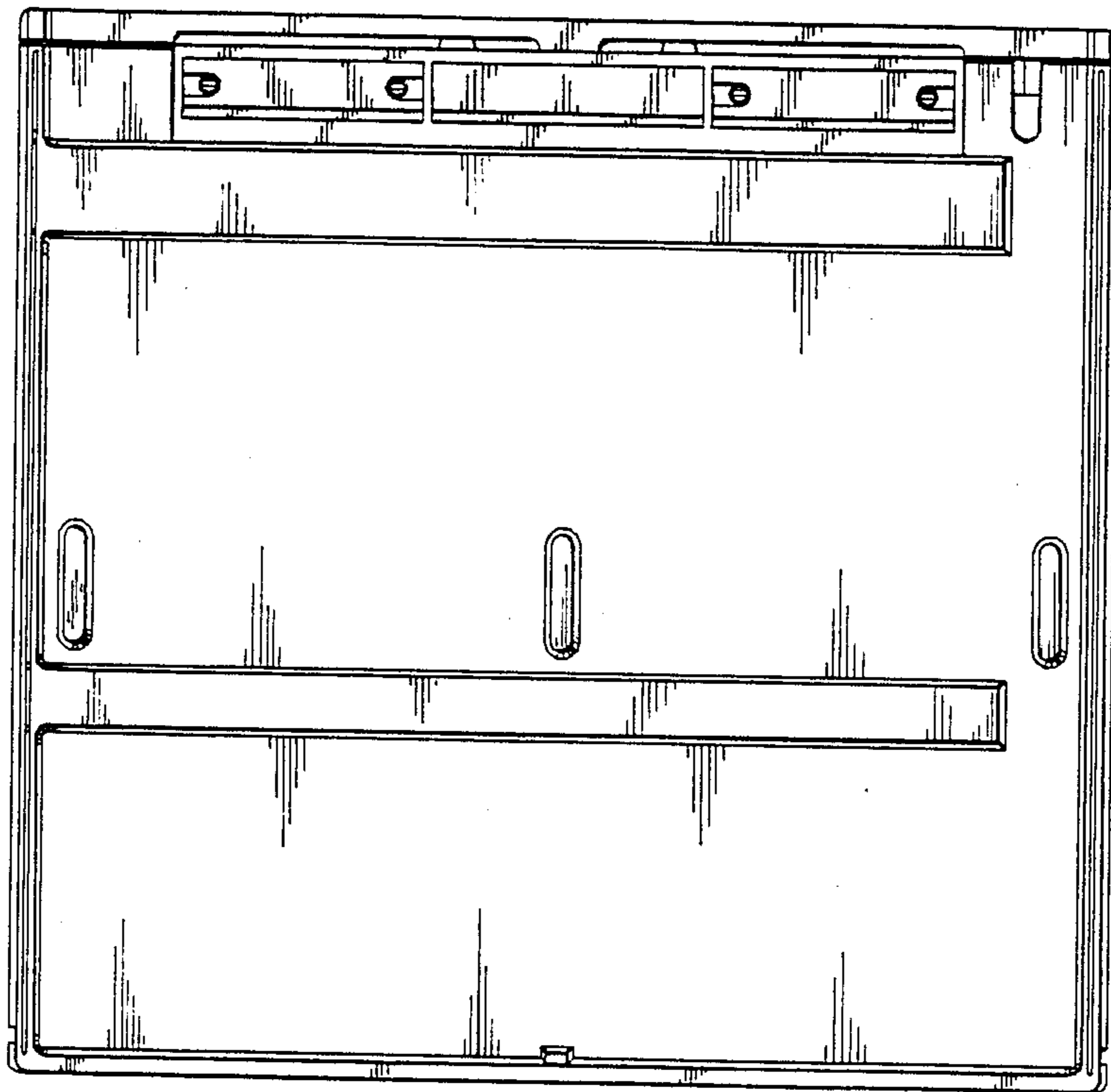

FIG. 7

