

[54] RESTAURANT BUILDING OR SIMILAR ARTICLE

DESCRIPTION

[75] Inventors: Lawrence Fournier, Columbus; David C. Rader, Gahanna, both of Ohio

[73] Assignee: Rax Restaurants, Inc., Columbus, Ohio

[**] Term: 14 Years

[21] Appl. No.: 708,031

[22] Filed: Mar. 1, 1985

[52] U.S. Cl. D25/1; D25/18; D25/33

[58] Field of Search D25/7, 18, 19, 33

[56] References Cited

U.S. PATENT DOCUMENTS

- D. 246,669 12/1977 Spears D25/31 X
- D. 258,008 1/1981 Ross D25/1 X
- D. 265,349 7/1982 Zil D25/18 X

Primary Examiner—A. Hugo Word
Attorney, Agent, or Firm—Berman, Aisenberg & Platt

[57] CLAIM

The ornamental design for a restaurant building or similar article, as shown and described.

FIG. 1 is a top plan view of the first embodiment of a restaurant building or similar article, showing our new design;

FIG. 2 is a front elevation view of the first embodiment;

FIG. 3 is a rear elevation view of the first embodiment;

FIG. 4 is a side elevation view of the first embodiment;

FIG. 5 is an elevation view of the side of the first embodiment opposite from the side shown in FIG. 4;

FIG. 6 is a top plan view of a second embodiment of the building according to our invention;

FIG. 7 is a front elevation view of the second embodiment;

FIG. 8 is a rear elevation view of the second embodiment;

FIG. 9 is a side elevation view of the second embodiment;

FIG. 10 is an elevation view of the side of the second embodiment opposite from the side shown in FIG. 9;

FIG. 11 is a top plan view of a third embodiment of the building according to our invention;

FIG. 12 is a front elevation view of the third embodiment;

FIG. 13 is a rear elevation view of the third embodiment;

FIG. 14 is a side elevation view of the third embodiment;

FIG. 15 is an elevation view of the side of the third embodiment opposite from the side shown in FIG. 14.

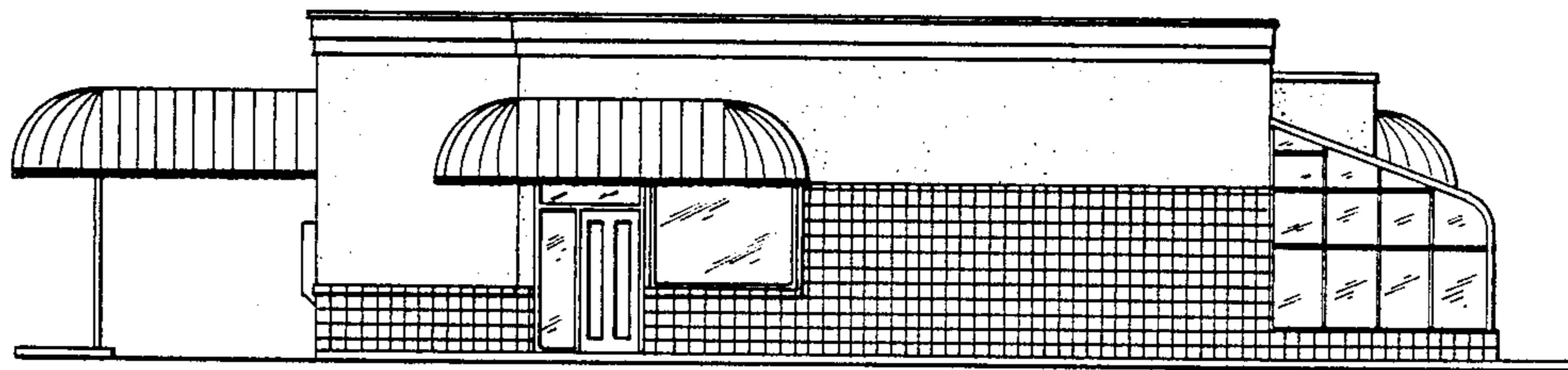
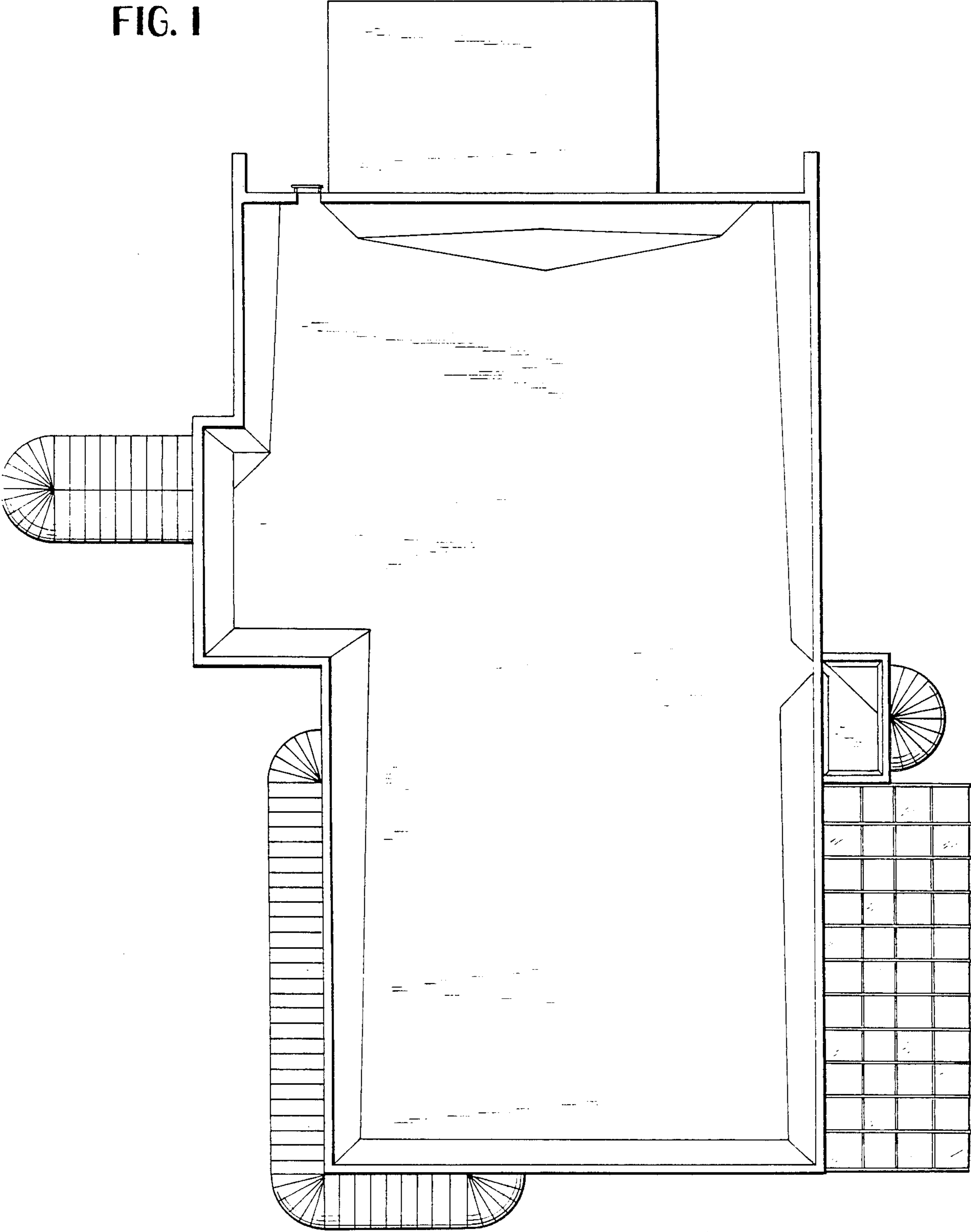

FIG. 1



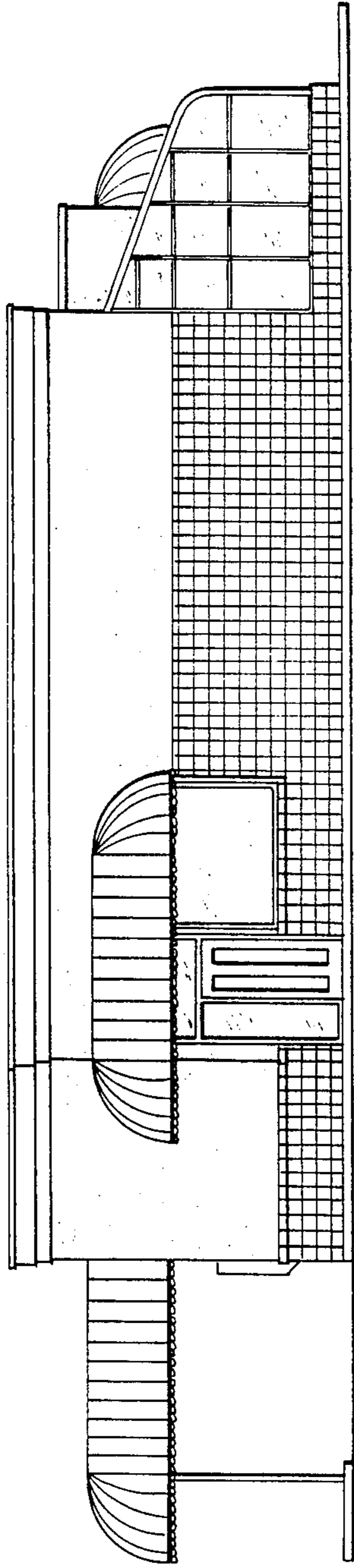

FIG. 2

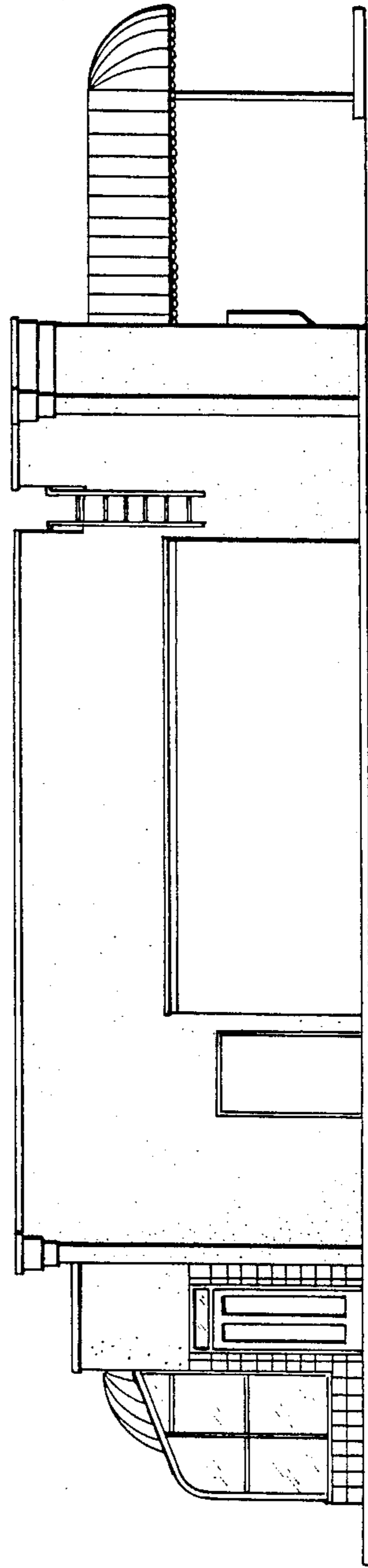

FIG. 3

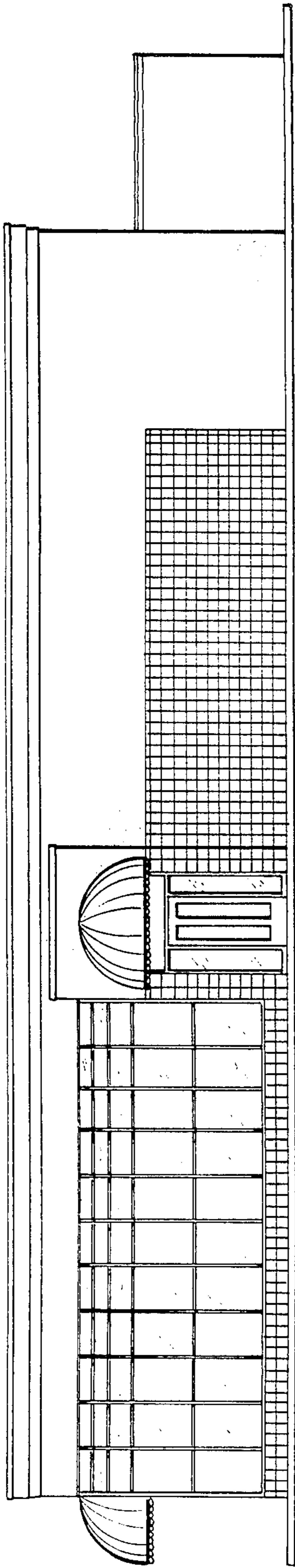

FIG. 4

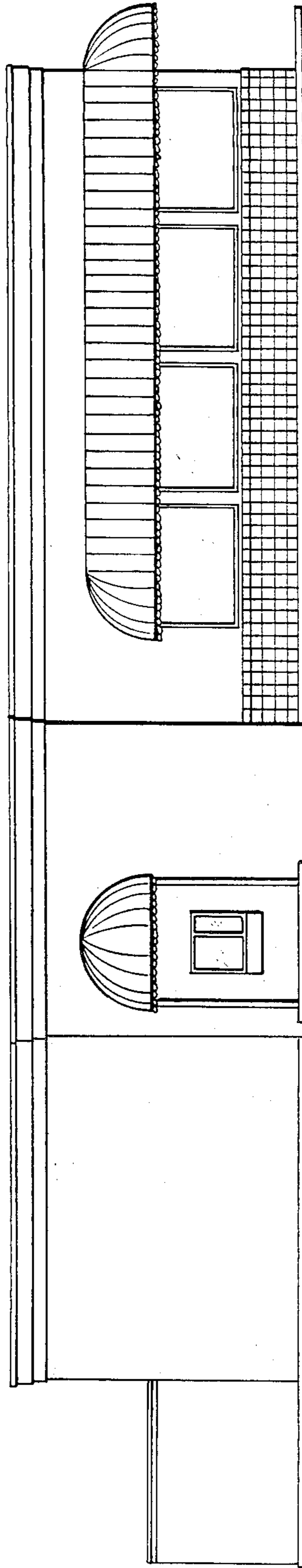
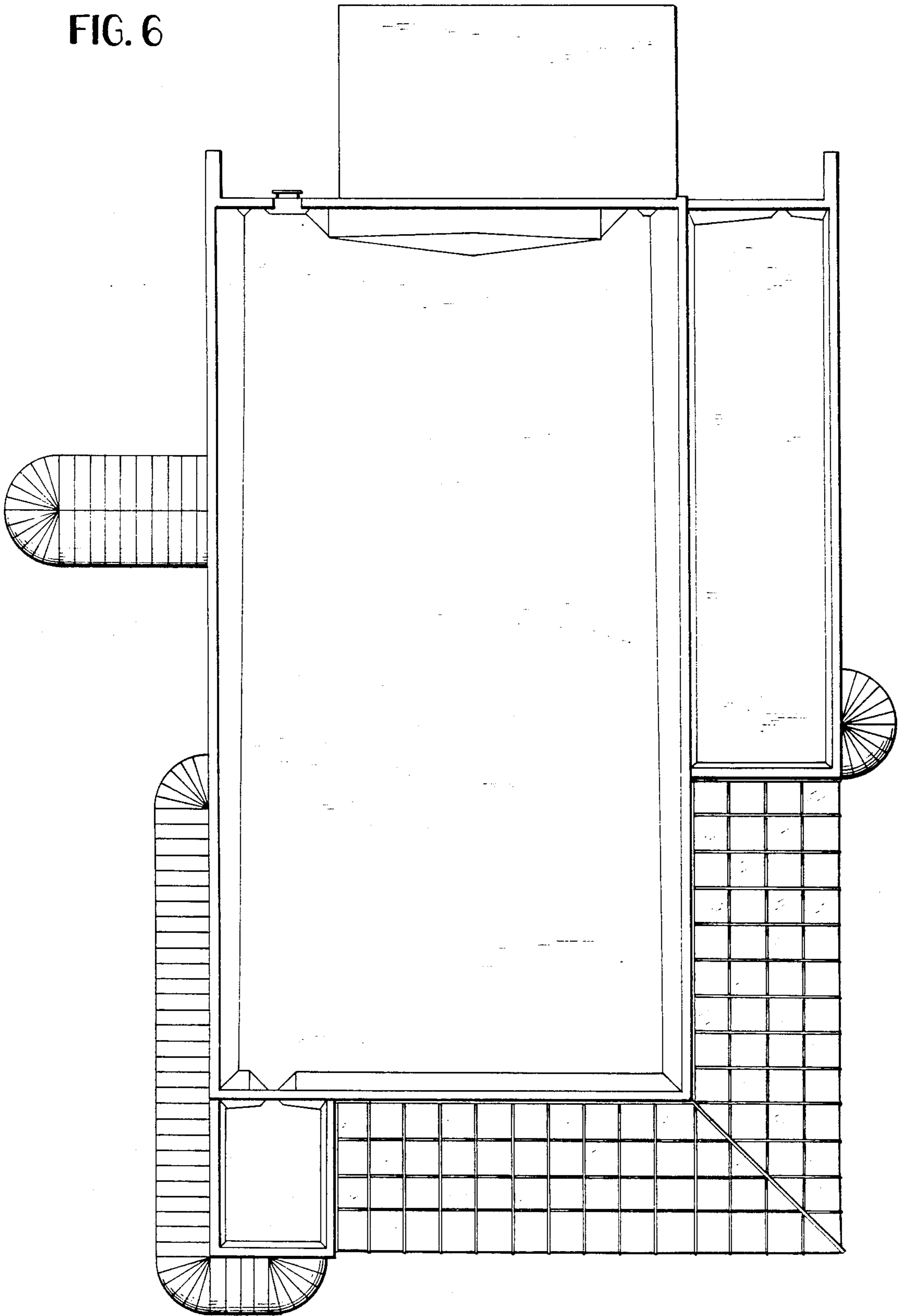

FIG. 5

FIG. 6



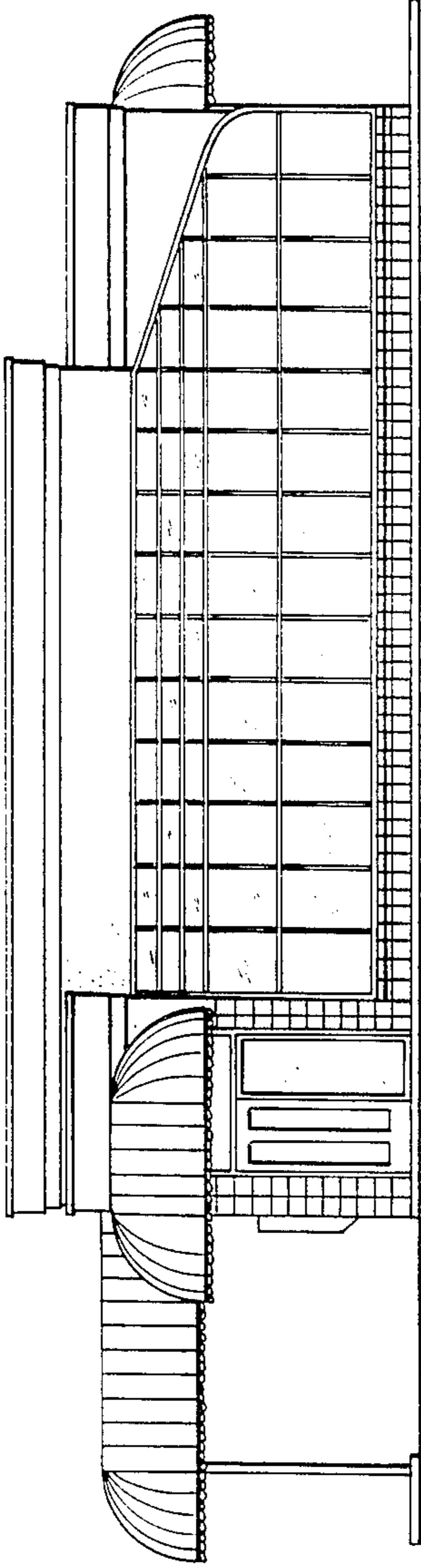

FIG. 7

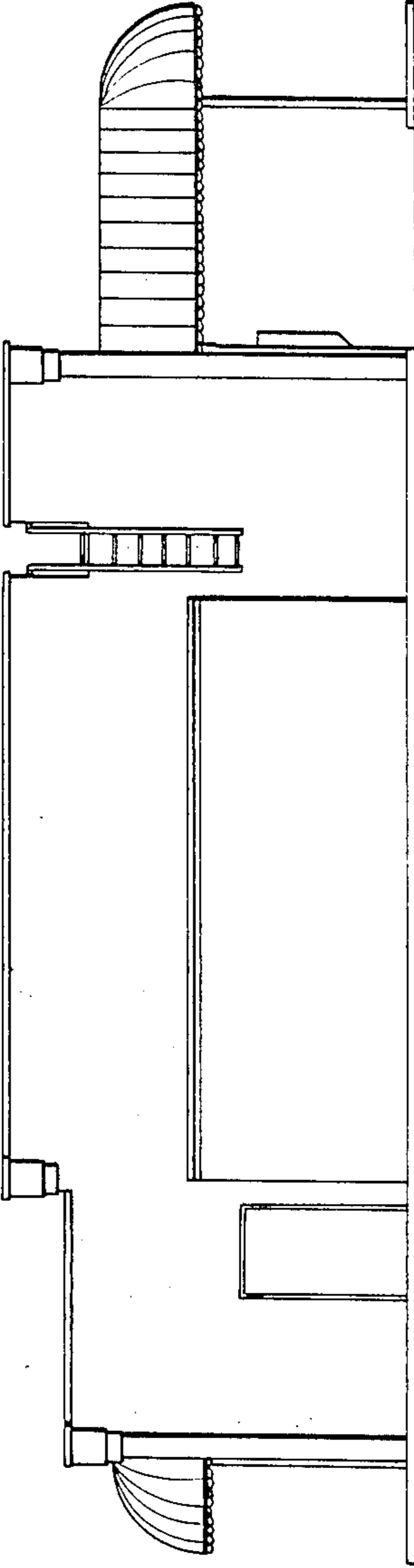

FIG. 8

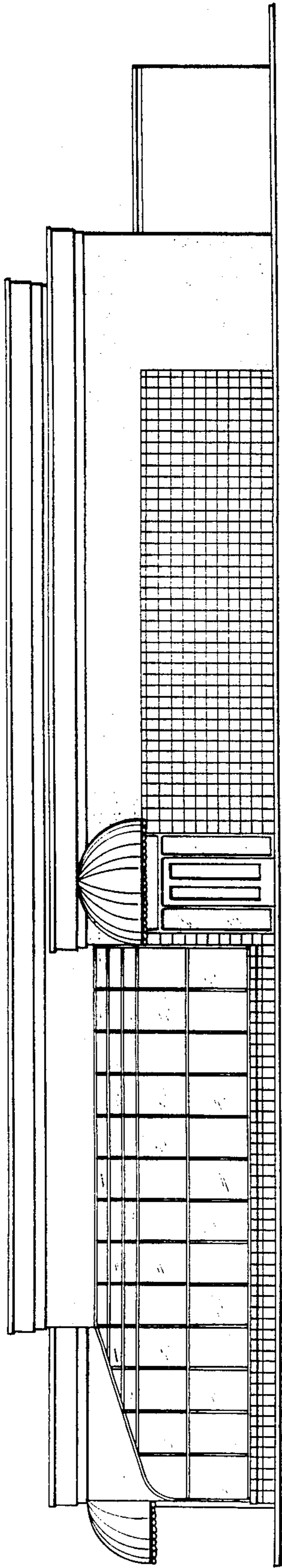

FIG. 9

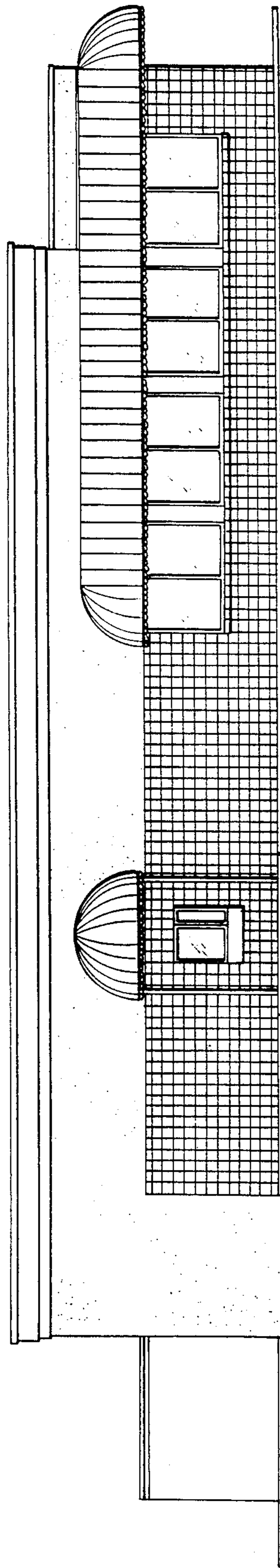

FIG. 10

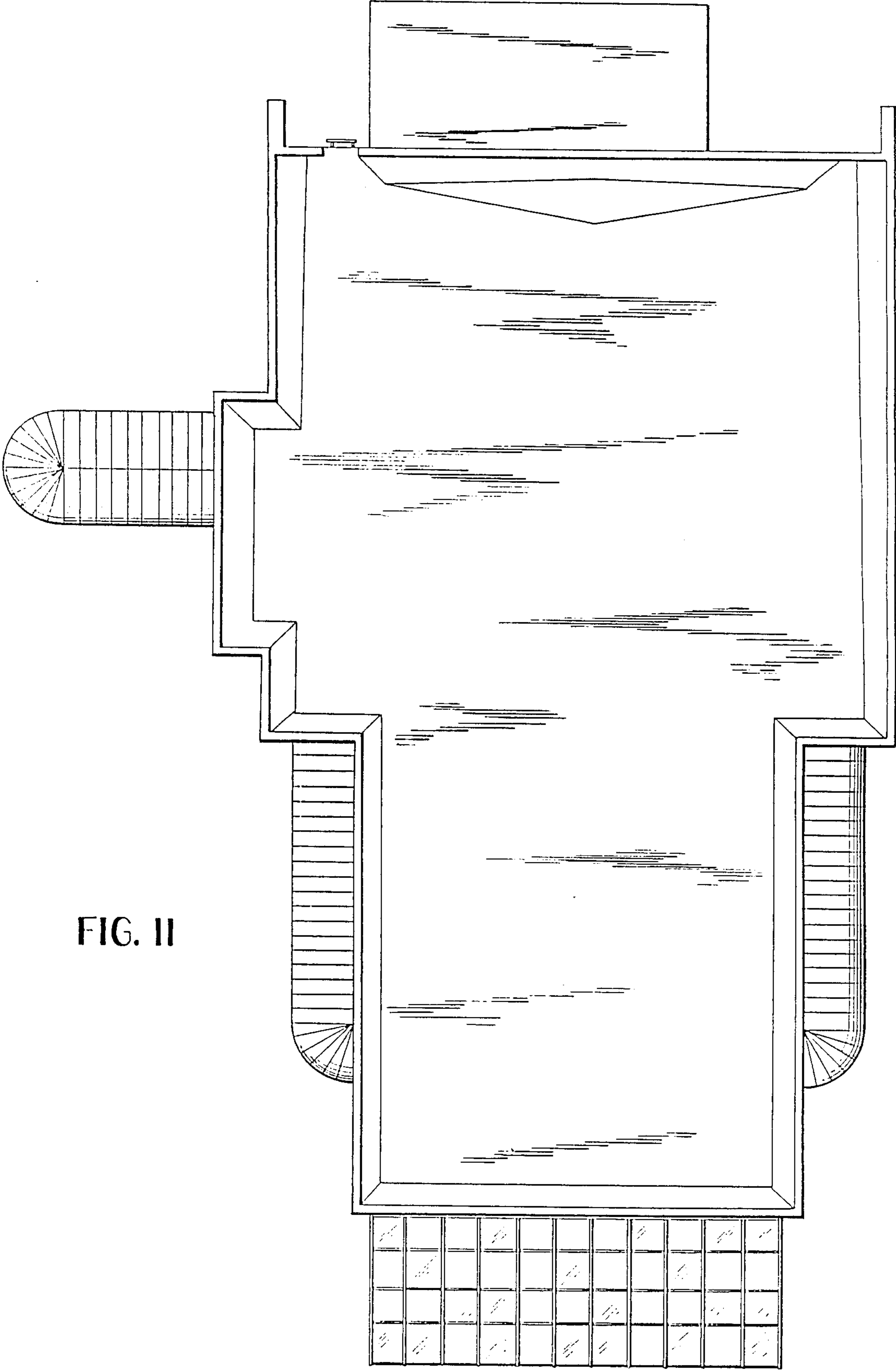

FIG. II

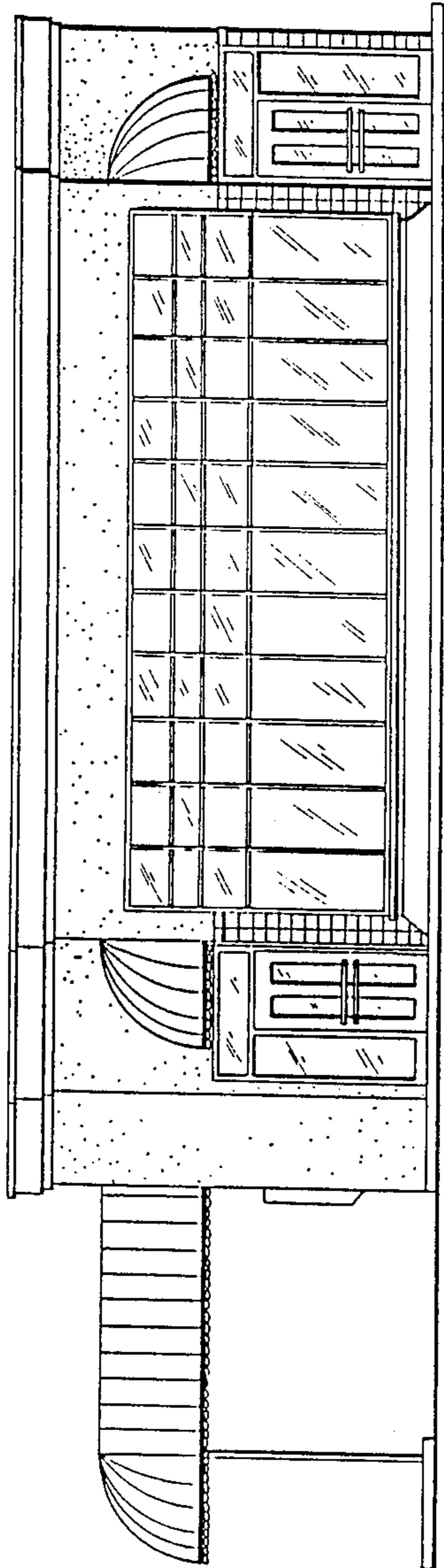

FIG. 12

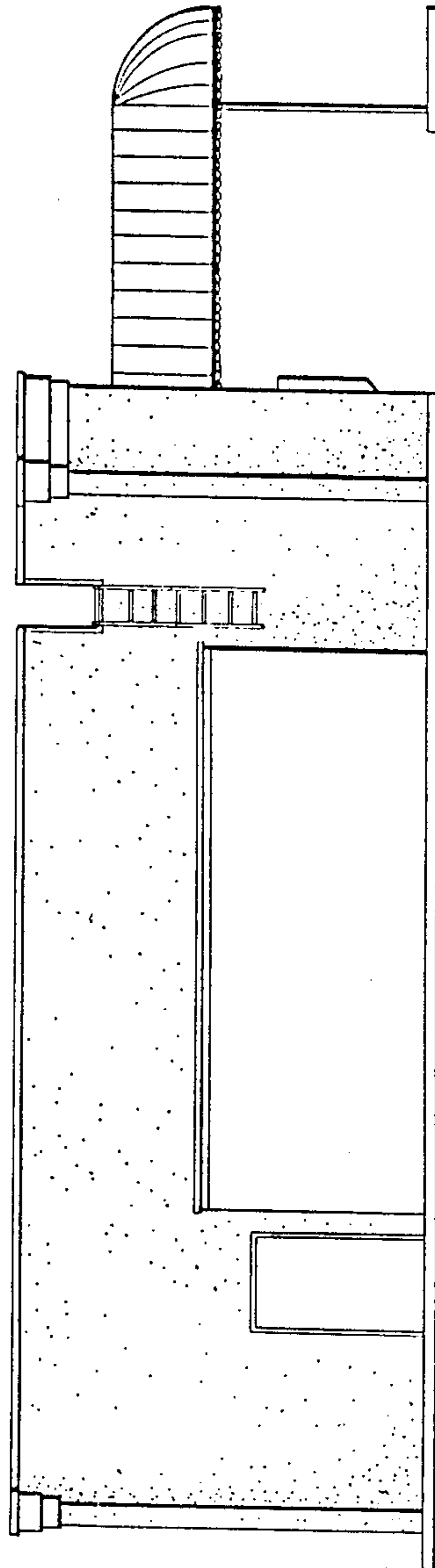

FIG. 13

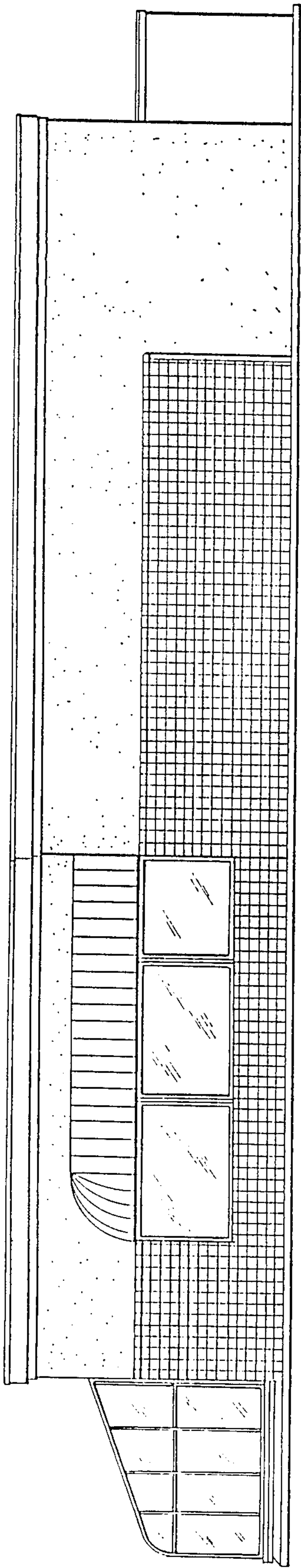

FIG. 14

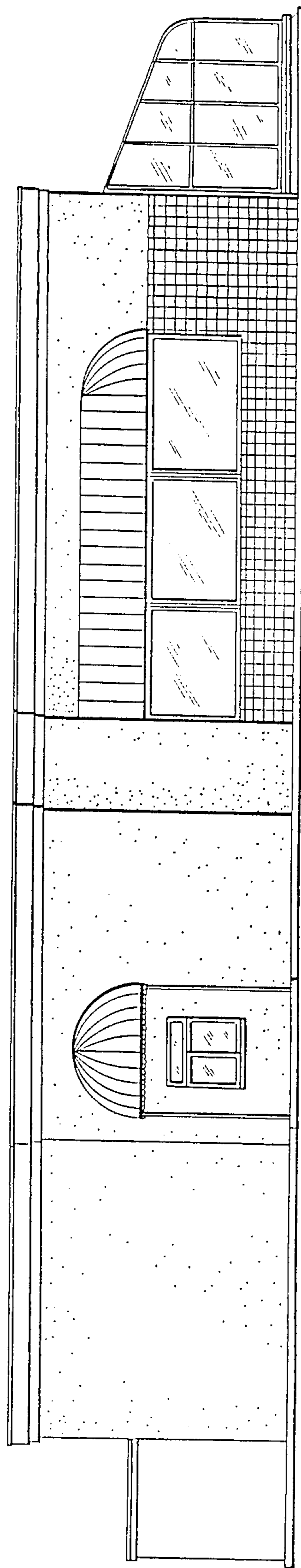

FIG. 15