

[54] FASCIA-MOUNTED ROOF VENTILATOR

[75] Inventors: David Bottomore, Meltham, Huddersfield; Colin F. Gibson, Nottingham, both of England

[73] Assignee: Glidevale Building and Products Limited, Nottingham, England

[**] Term: 14 Years

[21] Appl. No.: 713,026

[22] Filed: Mar. 18, 1985

[30] Foreign Application Priority Data

Sep. 21, 1984 [GB] United Kingdom 1022171
[52] U.S. Cl. D23/373
[58] Field of Search D23/139-140, D23/155, 158, 161-163; 98/29, 33, 37, 55, DIG. 6, DIG. 32; 52/95, 199, 302, 473

[56] References Cited

U.S. PATENT DOCUMENTS

D. 232,310 8/1984 France D23/139
D. 241,033 8/1976 France D23/151 X
D. 271,713 12/1983 Hicks D23/151
D. 277,312 1/1985 Williamson et al. D23/153

3,777,649 12/1973 Luckey 98/29 X
3,863,553 2/1975 Koontz 98/32
4,189,878 2/1980 Fitzgerald 98/37 X
4,214,510 7/1980 Ward 98/32 X

Primary Examiner—Wallace R. Burke
Assistant Examiner—Brian N. Vinson
Attorney, Agent, or Firm—Bachman & LaPointe

[57] CLAIM

The ornamental design for a fascia-mounted roof ventilator, substantially as shown and described.

DESCRIPTION

FIG. 1 is a top plan view of a fascia-mounted roof ventilator showing our new design, the article being shown broken-away to indicate indeterminate length;
FIG. 2 is a vertical transverse sectional view thereof, taken along line A—A of FIG. 5;
FIG. 3 is a right end elevational view thereof, the left end being a mirror image;
FIG. 4 is a front elevational view thereof;
FIG. 5 is a rear elevational view thereof;
FIG. 6 is a bottom plan view thereof;
FIG. 7 is a fragmentary top perspective view thereof; and
FIG. 8 is a fragmentary bottom perspective view thereof.

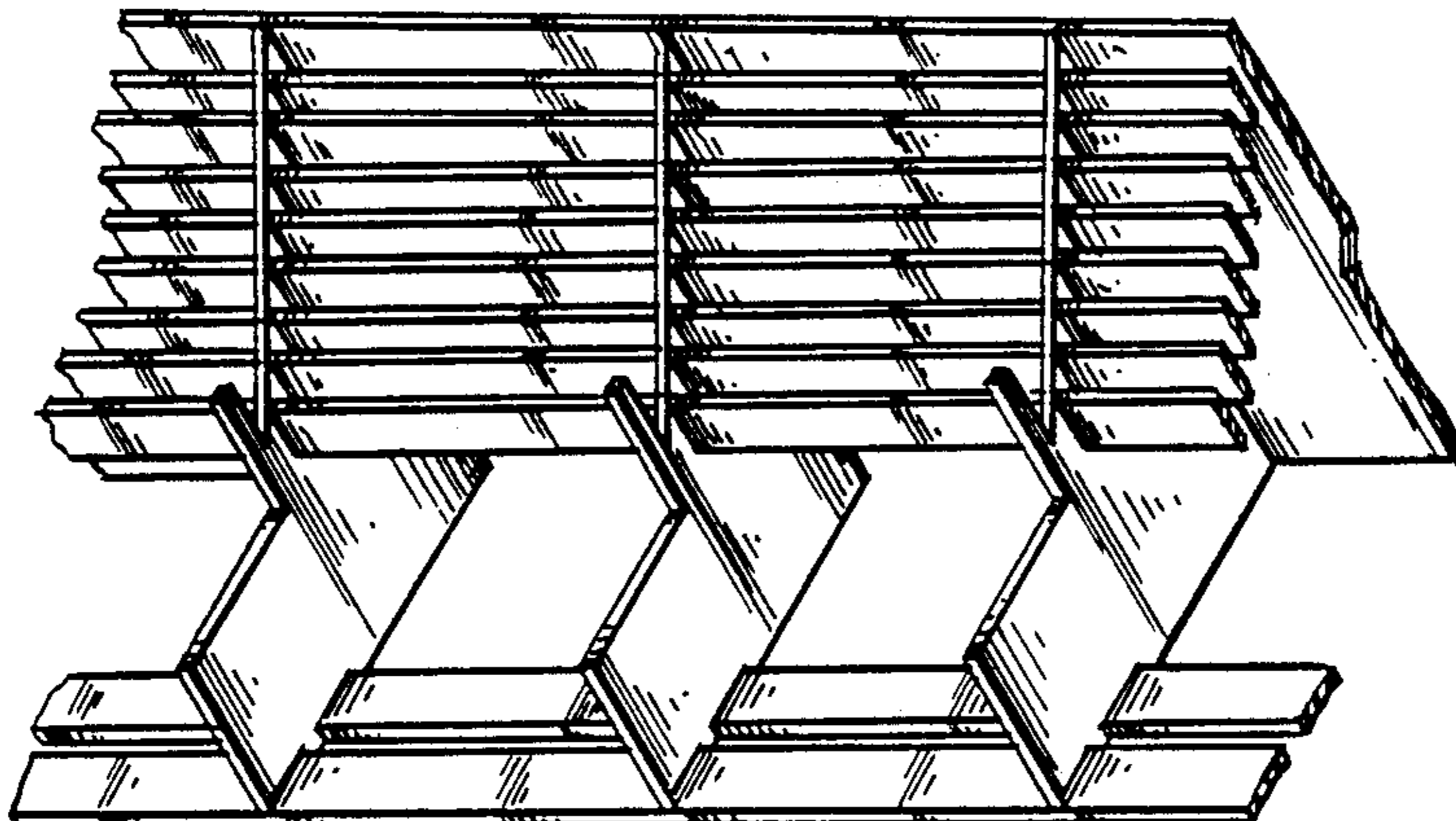
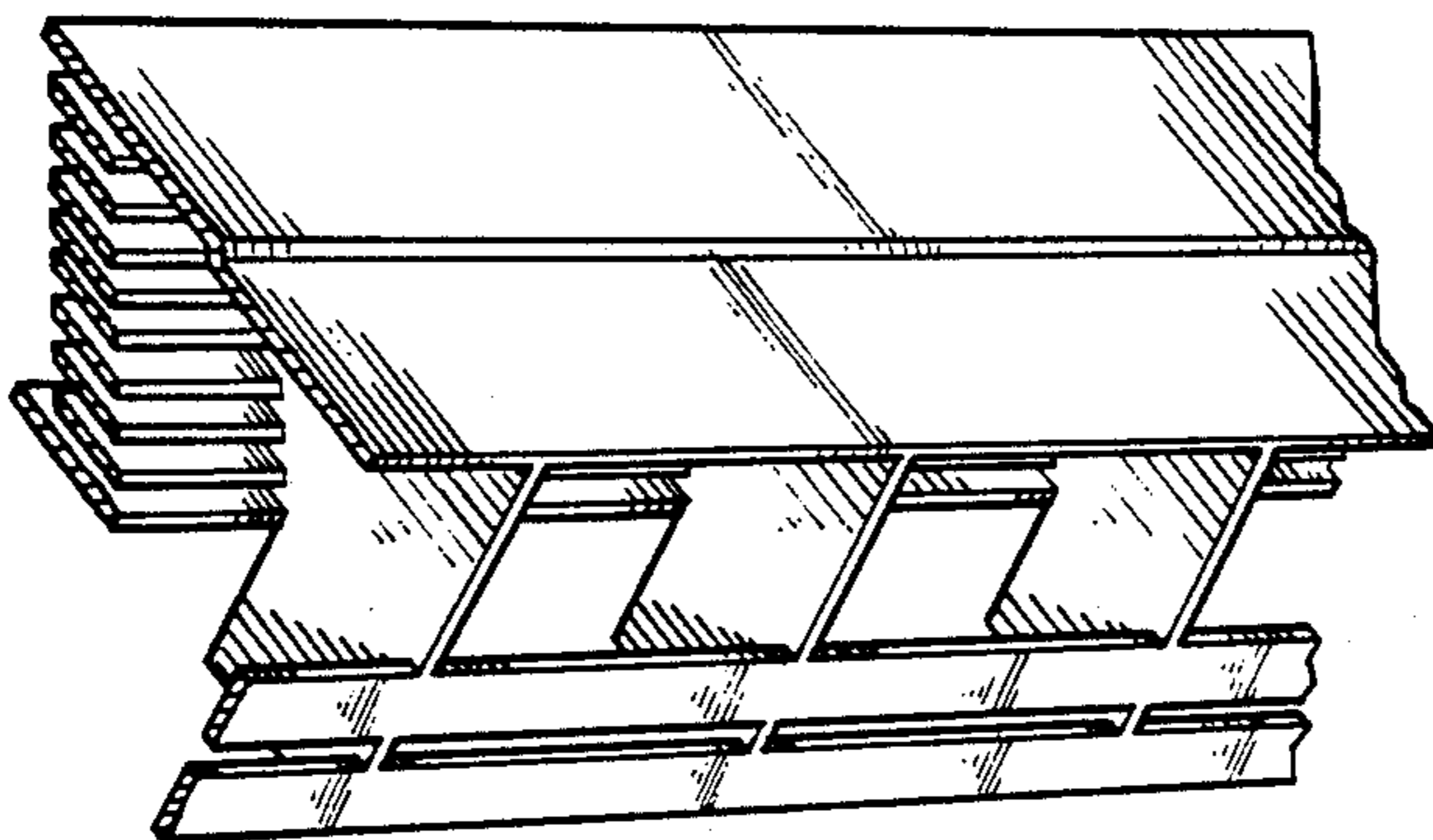

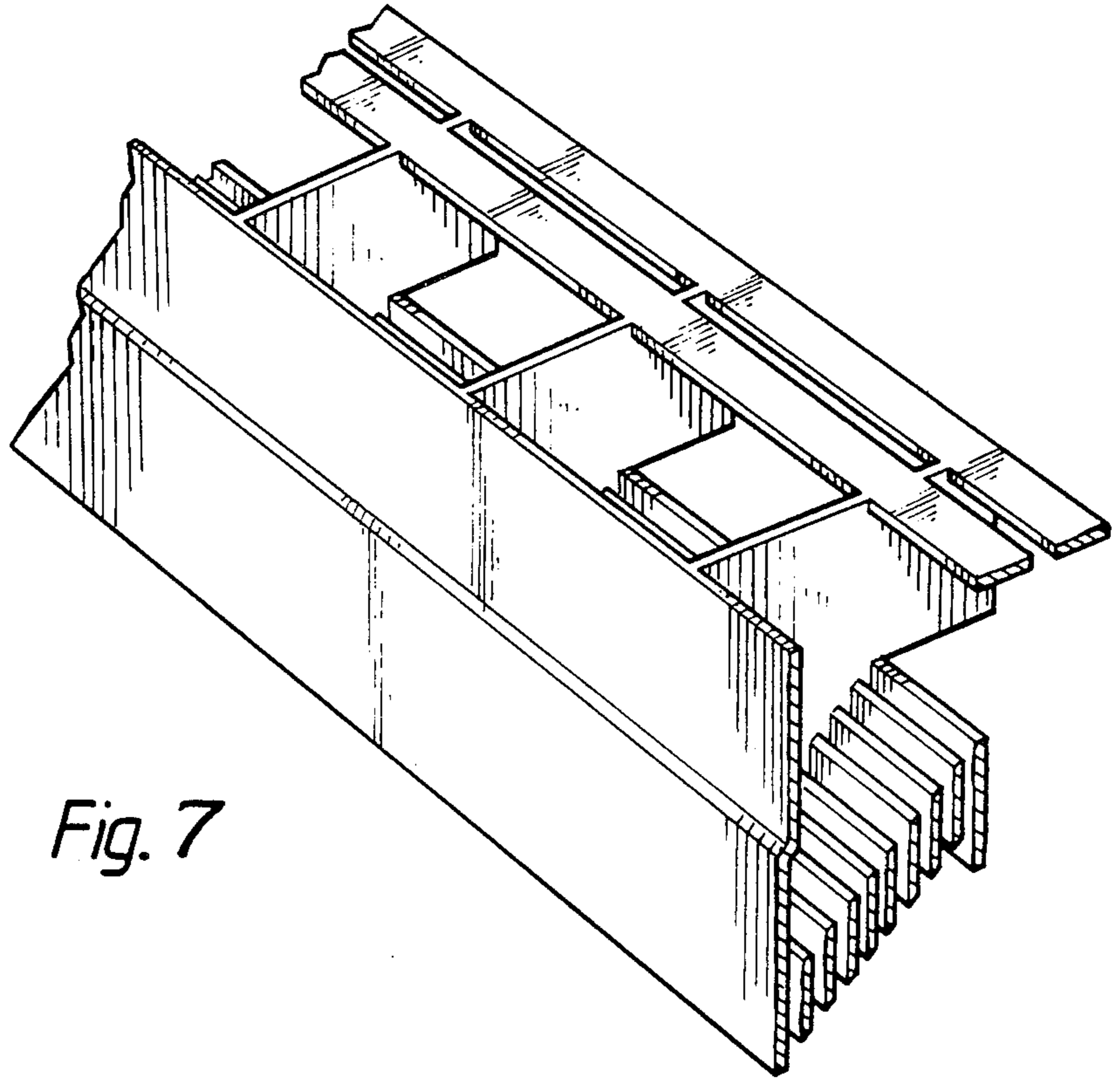

Fig. 7

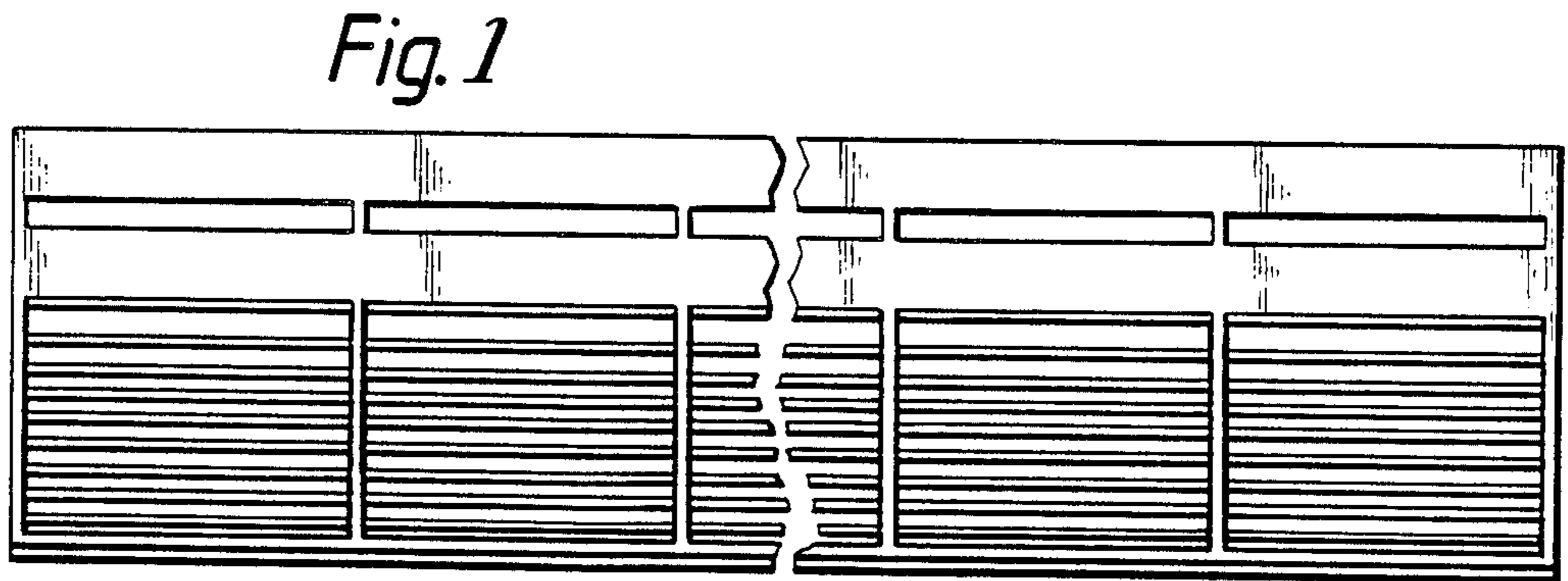

Fig. 1

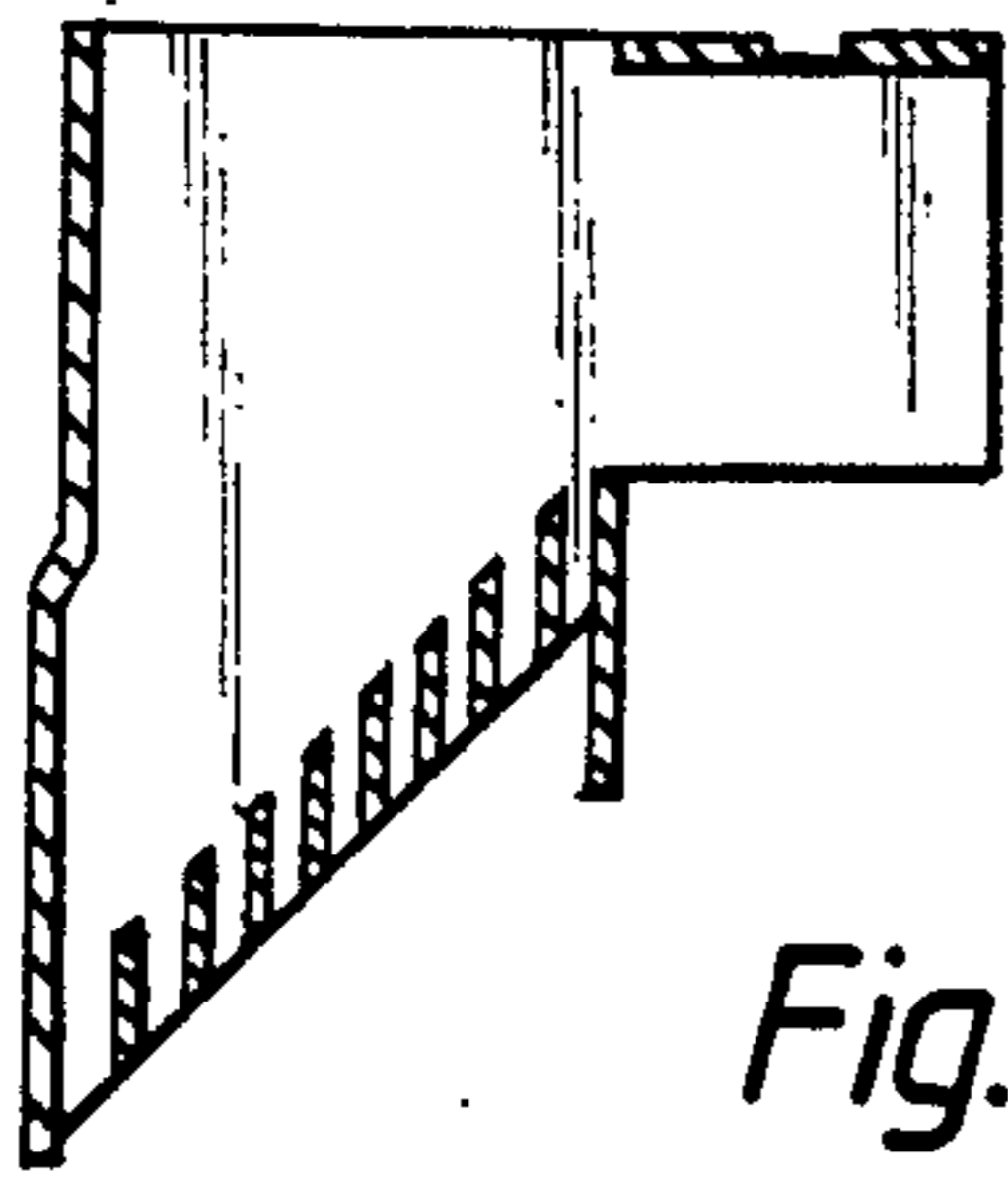

Fig. 2.

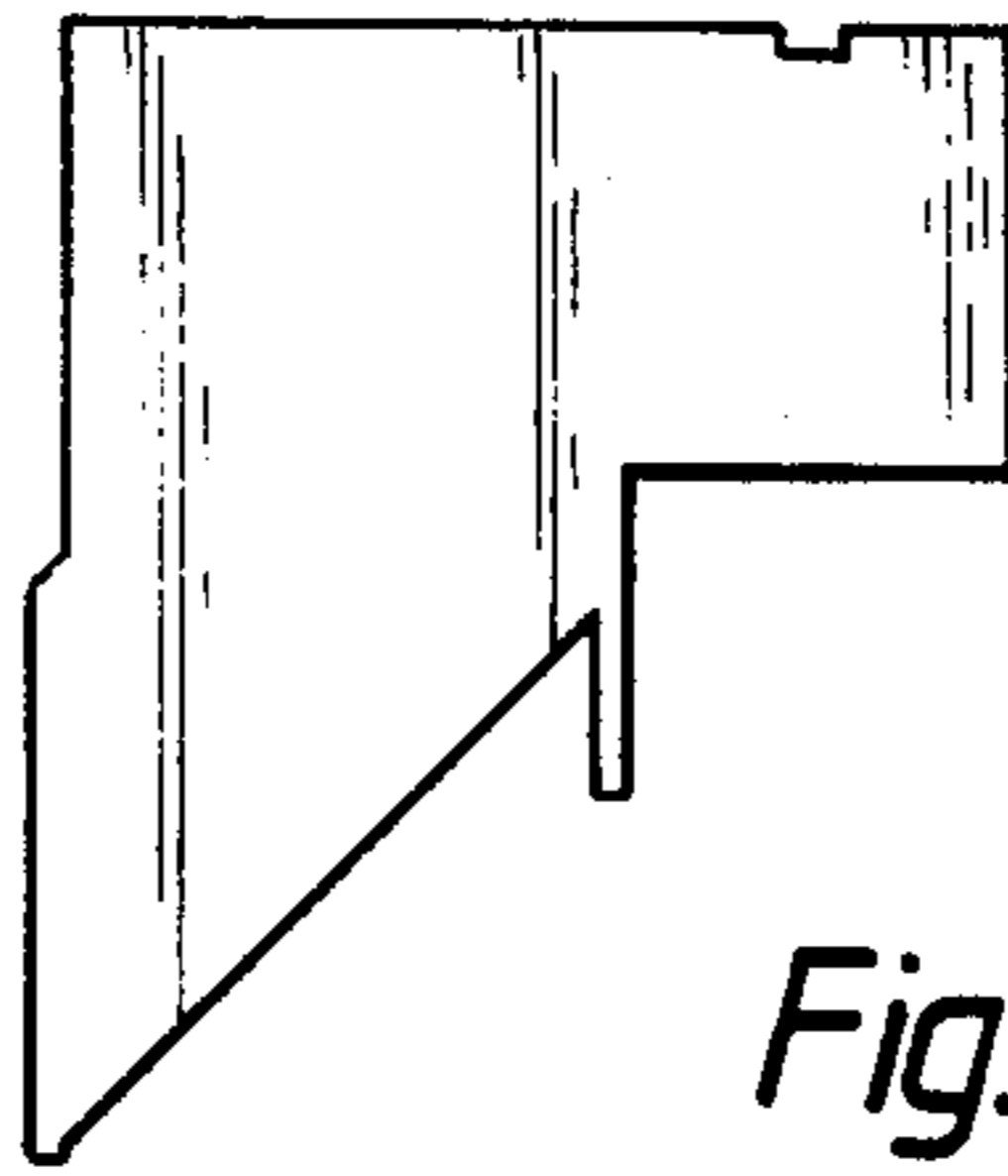

Fig. 3.

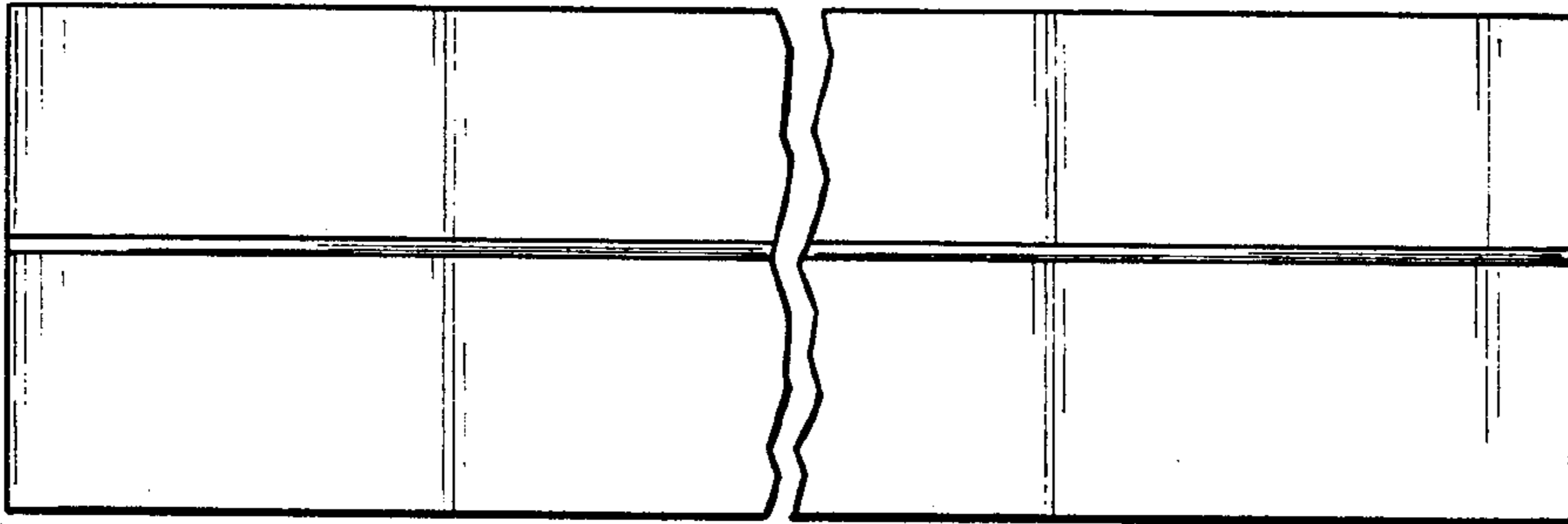

Fig. 4.

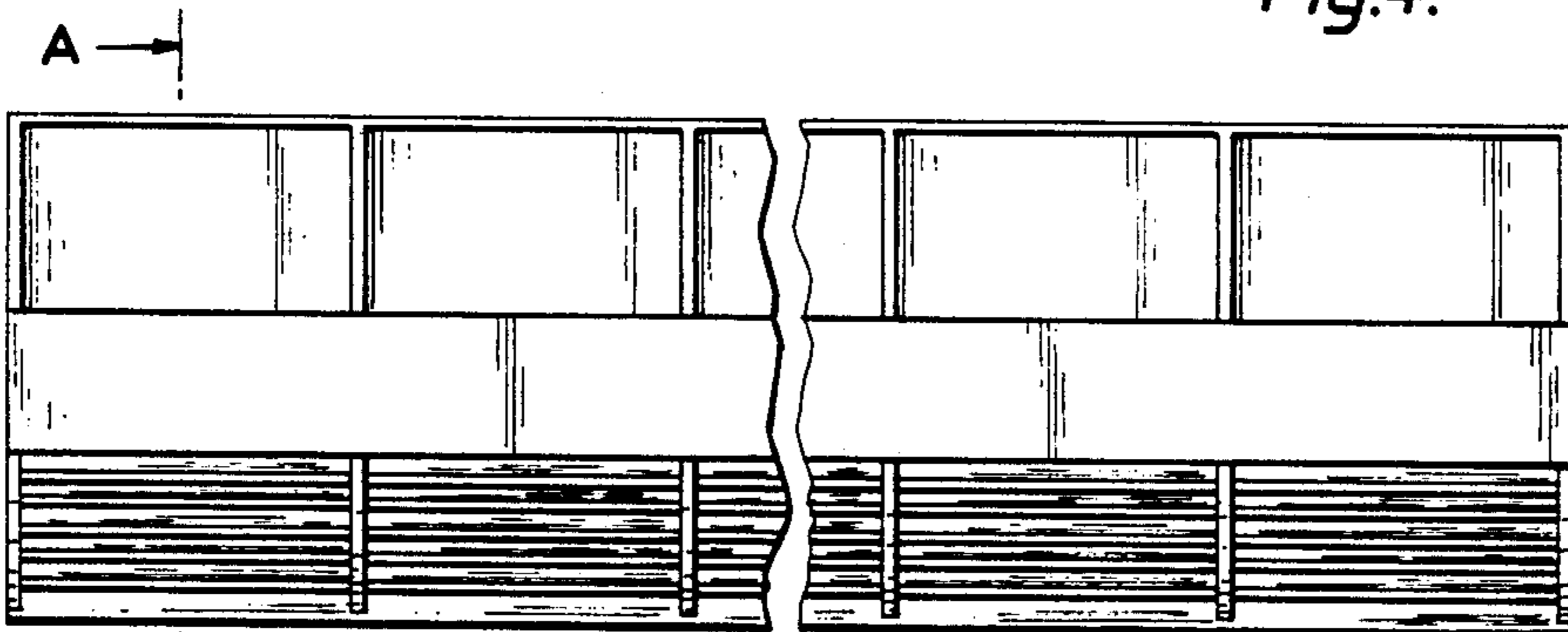

Fig. 5.

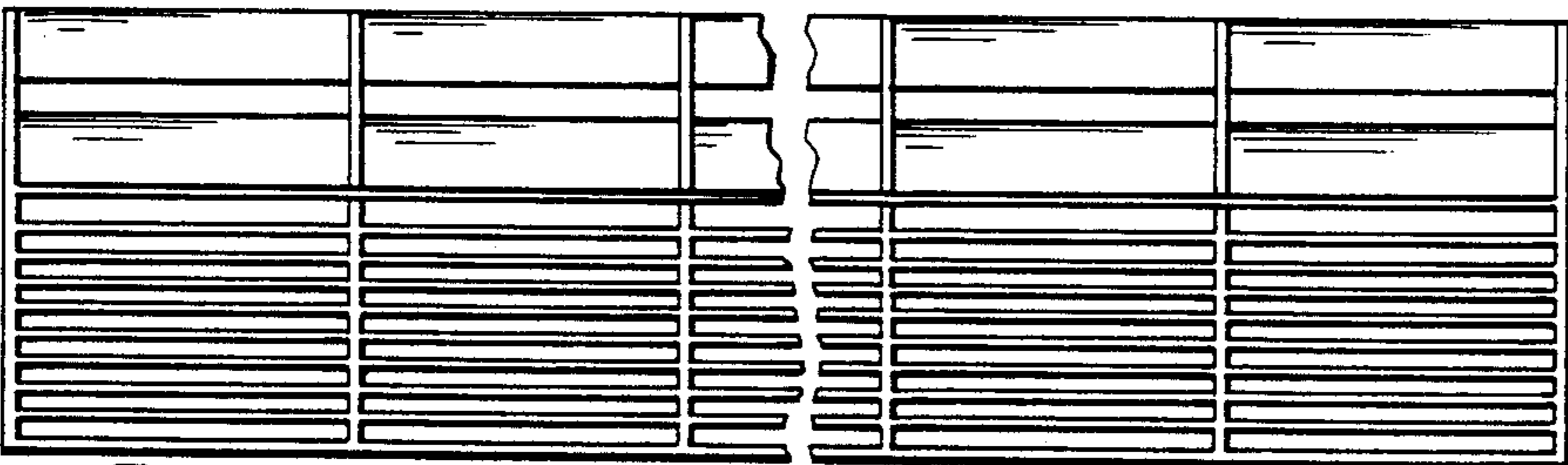

Fig. 6.

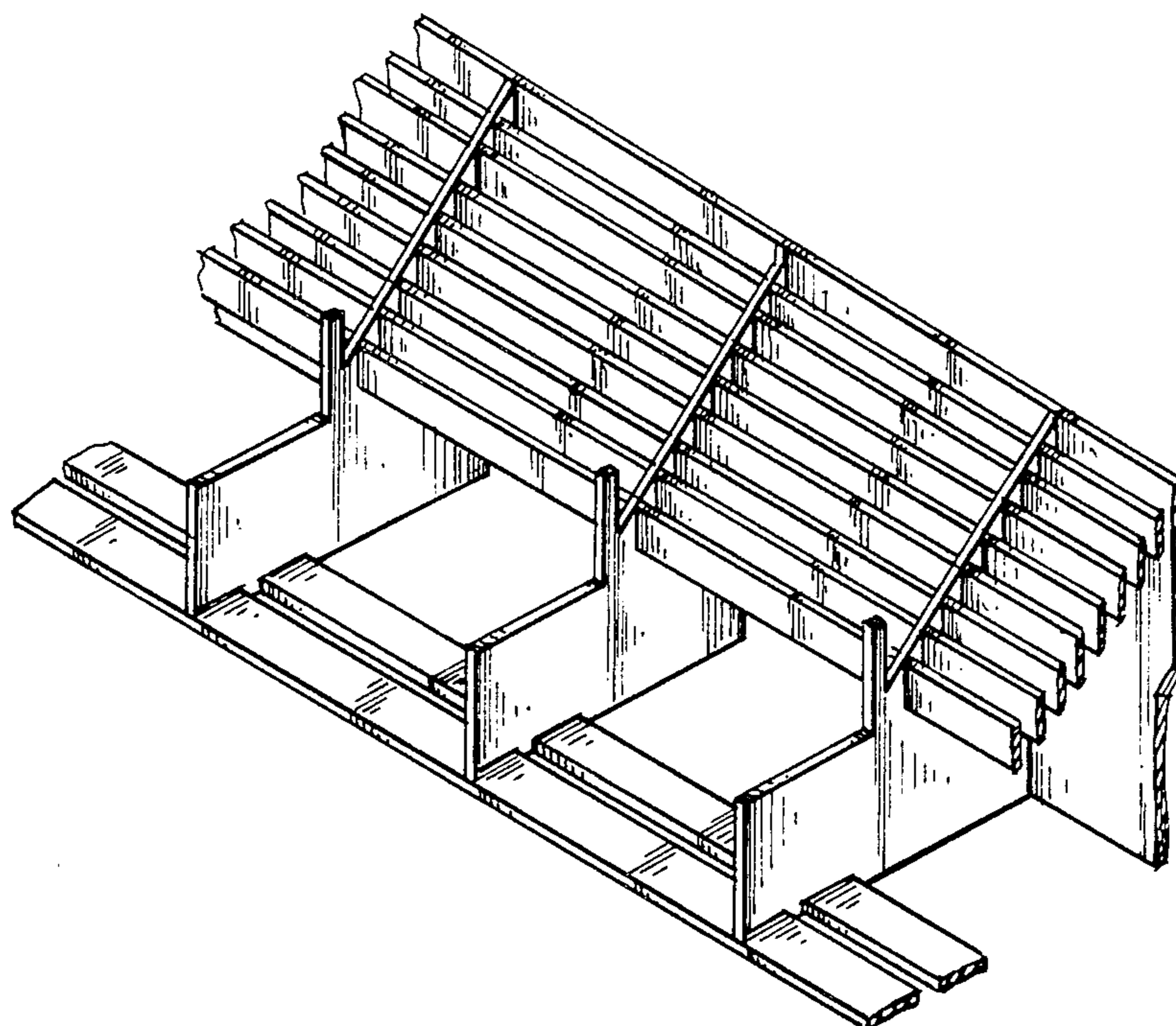

FIG - 8